

LEDGESTONE™

UNILOCK®

TECH SHEET

THICKNESS 70MM

REGION ONTARIO



APPLICATIONS

Note: Not all sizes are suitable for every application. Contact Unilock Representative for assistance.



Fire Feature

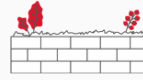

Garden Wall

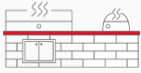

Outdoor Kitchen

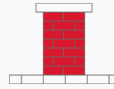

Pillars

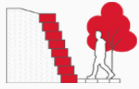

Retaining Wall



Seat Wall



Water Features

COLORS

**BUFF
FINISH: FLAGSTONE**

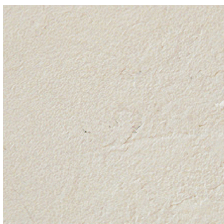

COPING
610mm x 70mm x 305mm
24" x 2 3/4" x 12"

TYPICAL CROSS SECTION

Note: Base, screed bed, infill aggregates and or reinforcements may vary based on project requirements or as specified by engineer.

LEDGESTONE STEPS

1. UNITS ARE PLACED DIRECTLY OVER GRAVEL BASE
2. ADHESIVE - OPTIONAL
3. 0.5 DEGREE FORWARD SLOPE FOR DRAINAGE

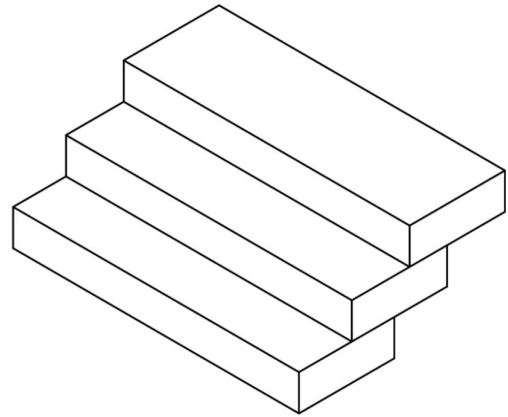
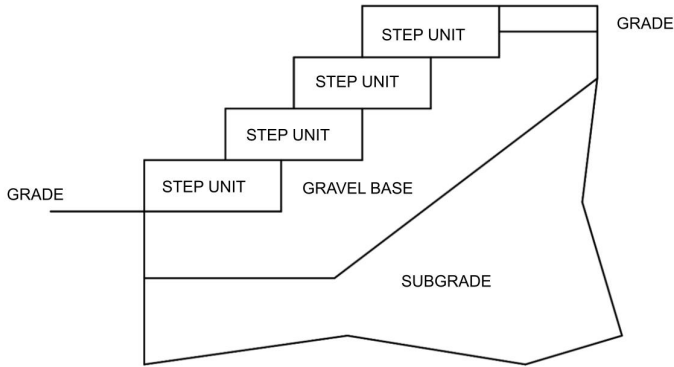

PACKAGING

	COPING
UNIT THICKNESS (MM)	70
LAYERS PER BUNDLE	4
FCFT PER BUNDLE	5.52
FCFT PER LAYER	1.38
FCFT PER UNIT	0.46
UNITS PER BUNDLE	12
UNITS PER LAYER	3
LBS PER BUNDLE	771.96
LBS PER LAYER	192.99
LBS PER UNIT	64.33

INSTALLATION NOTES

Ledgestone is a universal coping system that is turning heads with its remarkably natural appearance. Featuring pitched edges to work interchangeably with any wall, the design selections are optimized.

Applications – Coping for steps, pool edges, planters and walls. Units are designed for straight applications but radius applications can be achieved by cutting tapered units.

Connection – non-mechanical connection. Use appropriate concrete adhesive for connection between units. Install with tight joints or 3/16” gap between units and amend with an exterior latex caulking. Cutting may be required; a diamond blade saw is required to cut coping properly. Glue all coping using a specially formulated concrete adhesive that is strong and will not break down over time. Always read adhesive manufacturers’ directions prior to gluing. NOTE: always scarify (rough-up) the back surface of the coping units with a grinder prior to gluing so that you will have a strong secure connection.

Note: always slope Ledgestone units slightly (from front to back or back to front) to prevent pooling of water on the surface.

Handling – Handle gently to avoid chipping edges.

Contact Unilock Representative for actual color samples and availability. Unilock reserves the right to change product information without notice.

PDF Generated July 3, 2026, 10:15 am

UNILOCK