



CATALOG
OF DREAMS

2024







What do you see when you look at
a backyard, front porch, or driveway?

At Unilock, we see possibilities.

Possibilities to build works of art and personal
playgrounds. Possibilities to bring families together
for a birthday barbecue or a wedding reception.
Possibilities to transform your imagination into
remarkable outdoor spaces, and build connections
stronger than the concrete underfoot.

And we don't let possibilities go to waste. Built on
50 years of innovation and sustainability, Unilock
provides customers the tools to transform dreams
into reality. We connect you with proven contractors
and supply an endless canvas of materials, but the
final product is always uniquely yours. And when your
project is complete, you don't just have something
beautiful, you've changed the way you see the world.

So, where can you see possibilities, and how can we
help you build them?

UNILOCK TRANSFORMING **HARDSCAPES**

TABLE OF
Contents



Journey in style as you discover, dream, and learn about
our revolutionary Unilock products and resources.

6 DREAM

- | | | | |
|-----------|---------------------------|-----------|----------------------|
| 8 | Discover Unilock Finishes | 16 | Dream with Unilock |
| 10 | Choose your Color | 48 | Unilock Best in Show |
| 14 | Unique Touches | | |

50 PRODUCTS

- | | | | |
|-----------|----------------------|------------|------------------------|
| 52 | Product Categories | 88 | Pavers & Slabs |
| 54 | Think Green | 156 | Retaining Walls |
| 56 | Unilock Technologies | 180 | Coping, Steps & Treads |
| 62 | Collections | | |

188 LEARN & PLAN

- | | | | |
|------------|------------------------------|------------|---------------------|
| 192 | Project Planning Resources | 198 | Commercial Projects |
| 194 | Finding the Right Contractor | 200 | Quality Commitment |
| 196 | Installation 101 | | |



Dream

Begin with a dream
of what's possible

Imagine an outdoor space where the inspired use of patterns, textures and shapes not only creates design-envy, but elevates your world in the most beautifully functional way.

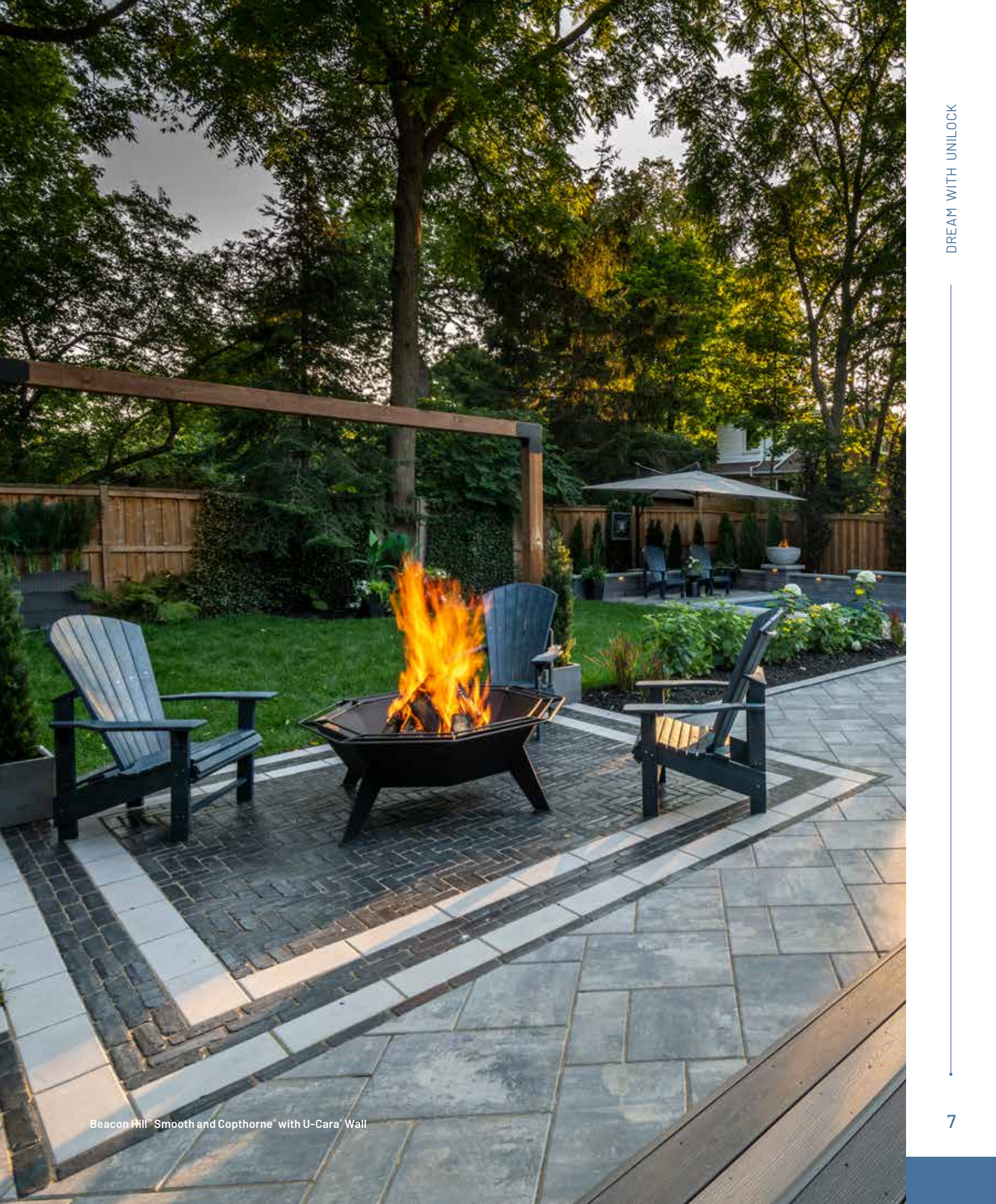

Beacon Hill™ Smooth and Copthorne® with U-Cara® Wall

Discover Unilock Coatings



Feels 3x better on bare feet
than ordinary pavers.

A special finishing process creates the ultra-smooth and silky surface texture of Comfort Step. This special technology results in a remarkably tight surface that is factory sealed to create a unique sensory experience that is velvety-smooth and cool underfoot.



Available exclusively on Elegance
and select EnduraColor products,
EasyClean enhances the surface color
and provides integral stain resistance.

Surface Finishes

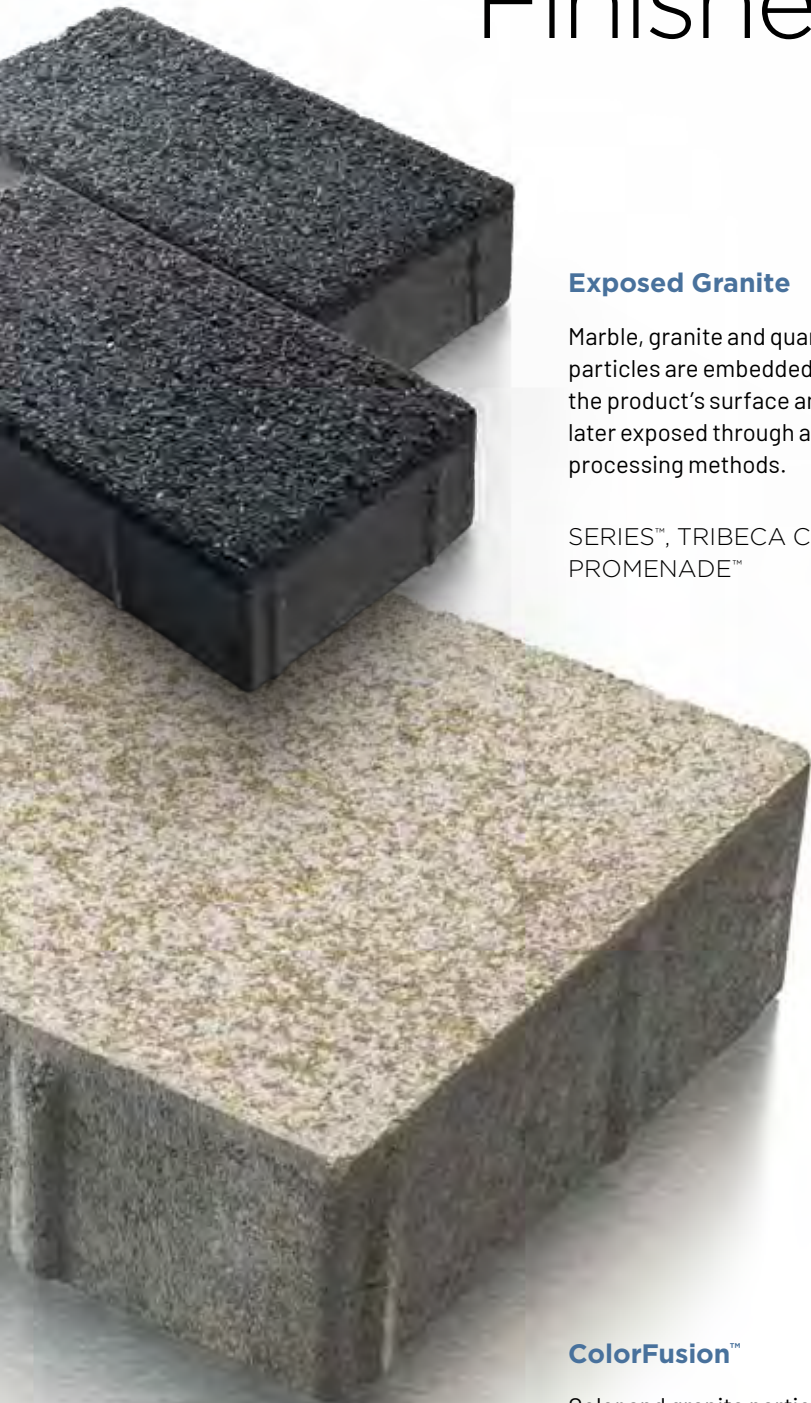

Exposed Granite

Marble, granite and quartz particles are embedded into the product's surface and are later exposed through additional processing methods.

SERIES™, TRIBECA COBBLE™, PROMENADE™

ColorFusion™

Color and granite particles are randomly dispersed to achieve a unique mottled surface.

UMBRIANO®, U-CARA®



Antiqued

Various methods are employed to obtain this weathered, timeworn finish, but in every instance, this patina improves the appearance.

BRUSSELS BLOCK®
BRUSSELS DIMENSIONAL™
MATTONI™

Artista

The look of boldly mottled granite is achieved with a proprietary process called Artista.

GRANITO™



Brushed

IL CAMPO®, PROMENADE™

Accentuated by artistically intriguing etched lines, this surface is available exclusively from Unilock.



Enhanced Surface

REVELA™, PROMENADE™



The surface of these products is enhanced using a special process to reveal a variety of distinctive colors and textures.



Choose your Color



MONOCHROMATIC OR CONTRAST

For an intimate atmosphere, dominate with warm colors, while still incorporating cool tones to create contrast and achieve a visual balance.



Choose your Shape

SHAPING YOUR OUTDOOR PROJECT

Finding the right shape to fit your outdoor project is like placing the last puzzle piece on an exquisite work of art. It just fits! What's more, combine different shapes together to deliver a two-for-one hardscape punch that will elevate your artistic vision to new heights.

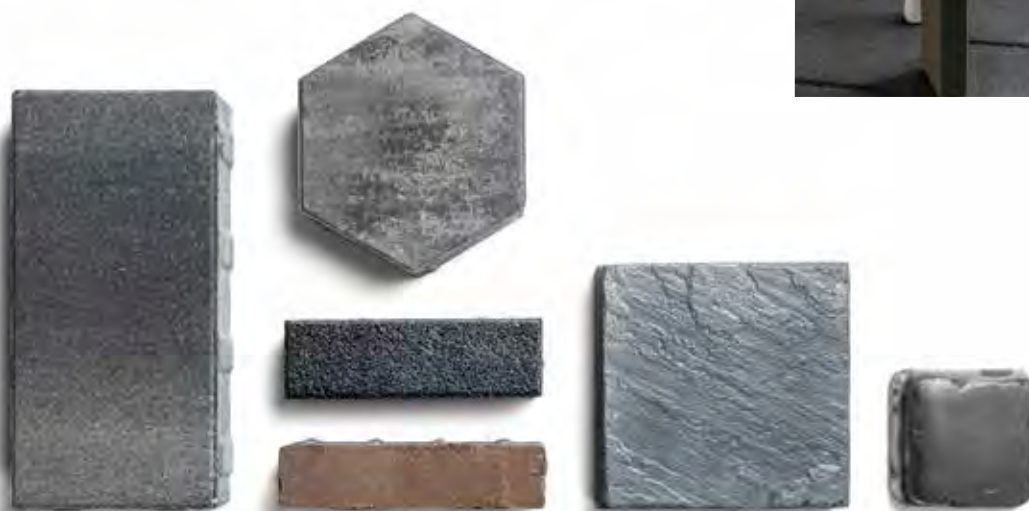

- RECTANGLE
- HEX
- SQUARE
- PLANK



What will you create?

Let your imagination run wild in the playground of Unilock paving products!



Find your Style

Whether you're designing a quaint backyard refuge or an ultra-modern driveway, we have a variety of paving products that'll turn your outdoor space into a little slice of heaven.

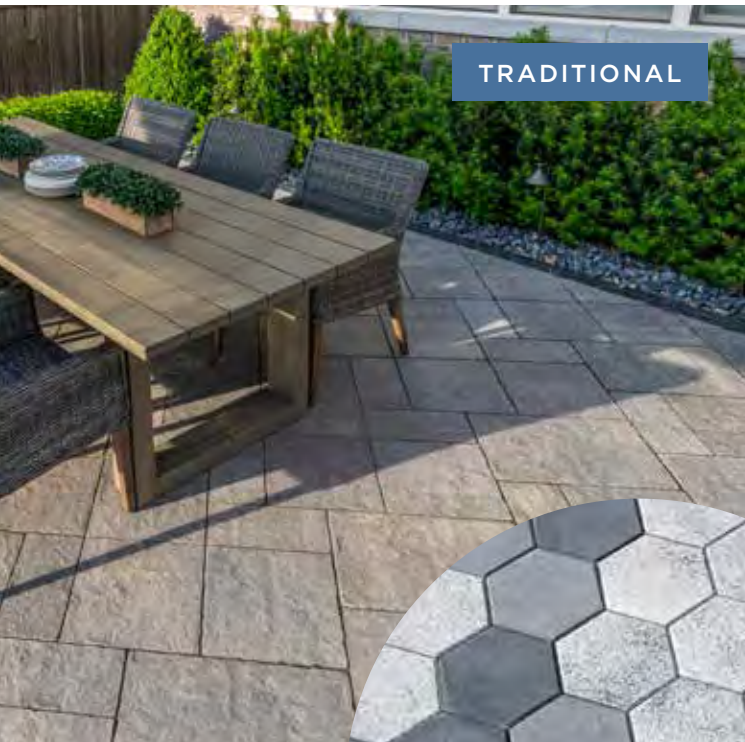

GEOMETRIC

Pick your Pattern

PLAY WITH ANGLES

From herringbone to basket weave, the right angle can make all the difference! A Unilock Authorized Contractor can recommend the best laying patterns based on the products you choose.



RANDOM

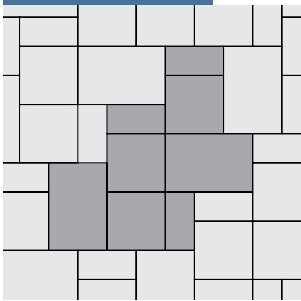

LINEAR

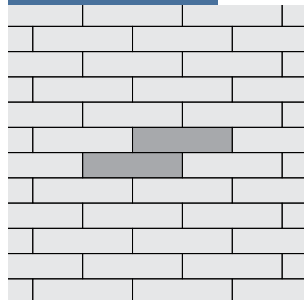

DESIGNER

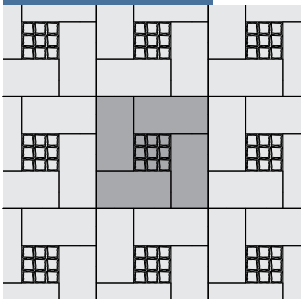

STACKED

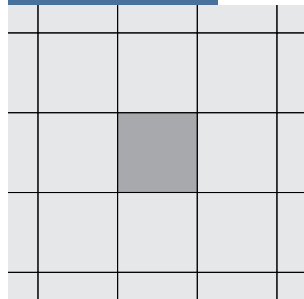

BASKETWEAVE

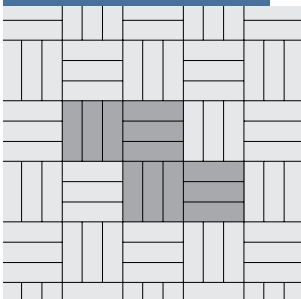

HERRINGBONE

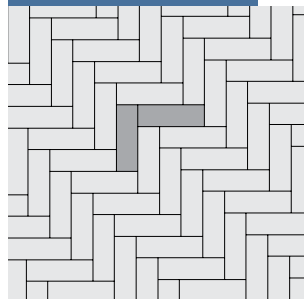

THINK OUTSIDE THE BOX

Distinct laying patterns can help define unique “rooms” across your outdoor space, giving you countless design options.

Visit Unilock.com for laying patterns.

Unique Touches

Let your creativity shine! Unilock border and banding options can help enhance your distinctive designs and add touches of elegance to your driveway, walkway, patio or vertical features.



Take it a step further with multiple borders, pixelated paver rugs or contrasting geometric grids.

JOINT MATERIAL

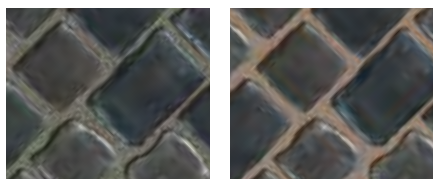

Joint material plays an important role between pavers by keeping out weeds and other debris. However, the color you choose can also have a dramatic impact on the look of your project. Your contractor can help you decide what will work best.



Make a dramatic impact with non-linear designs. Like the atypical array of hexagon-shaped pavers, or a pixelated look created with light and dark square pavers.



Clean, opposing angled lines in this poolside patio create the effect of a chevron, unifying upper and lower decks.

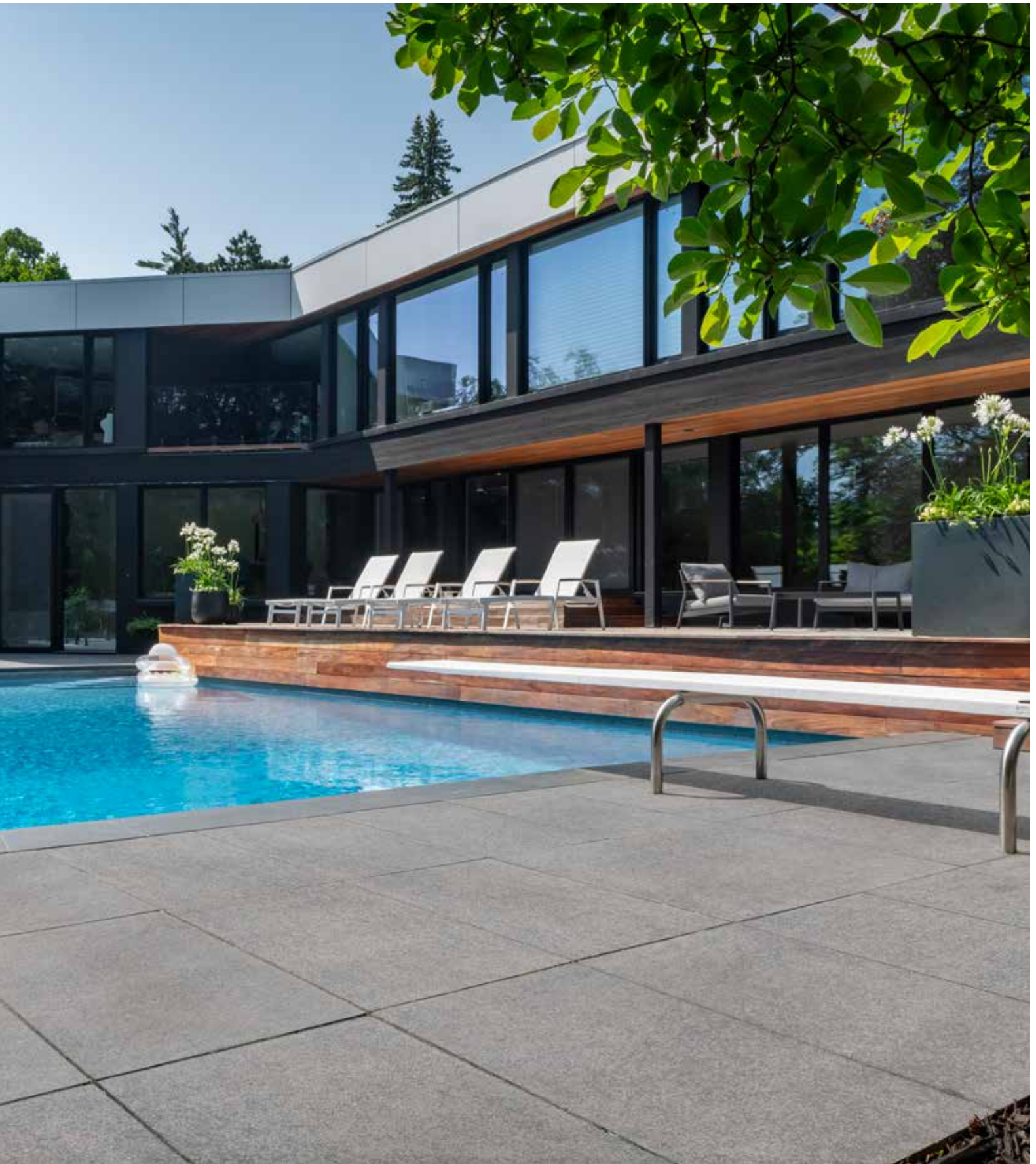



Slabs laid in a stacked bond pattern add to the long, clean lines of this contemporary pool area. Nearby steps lead to a natural-canopied setting for al fresco dining.

Pavers: Umbriano® (French Grey)

Walls and Steps: U-Cara®
Umbriano with Umbriano coping
(Winter Marvel)



Scan here for
project video



Scan here for
project video



Pavers: Beacon Hill™ Smooth Slab (Granite Mist) with Natural Stone (Black River) accent and Beacon Hill Smooth (Dark Charcoal) accents

Firepit and Kitchen: Lineo™ Dimensional Stone (Granite blend) with Beacon Hill Smooth (Dark Charcoal) accent





Large, contemporary slabs accented by contrasting paver bands create a generous sense of space for this intimate, multi-purpose backyard.

Scan here for
project video



Pavers: Urban™ (Indiana Buff)

Garden Walls, Pillar and Steps: U-Cara®
Smooth (Indiana Buff) with Umbriano®
(French Grey) Coping and step treads

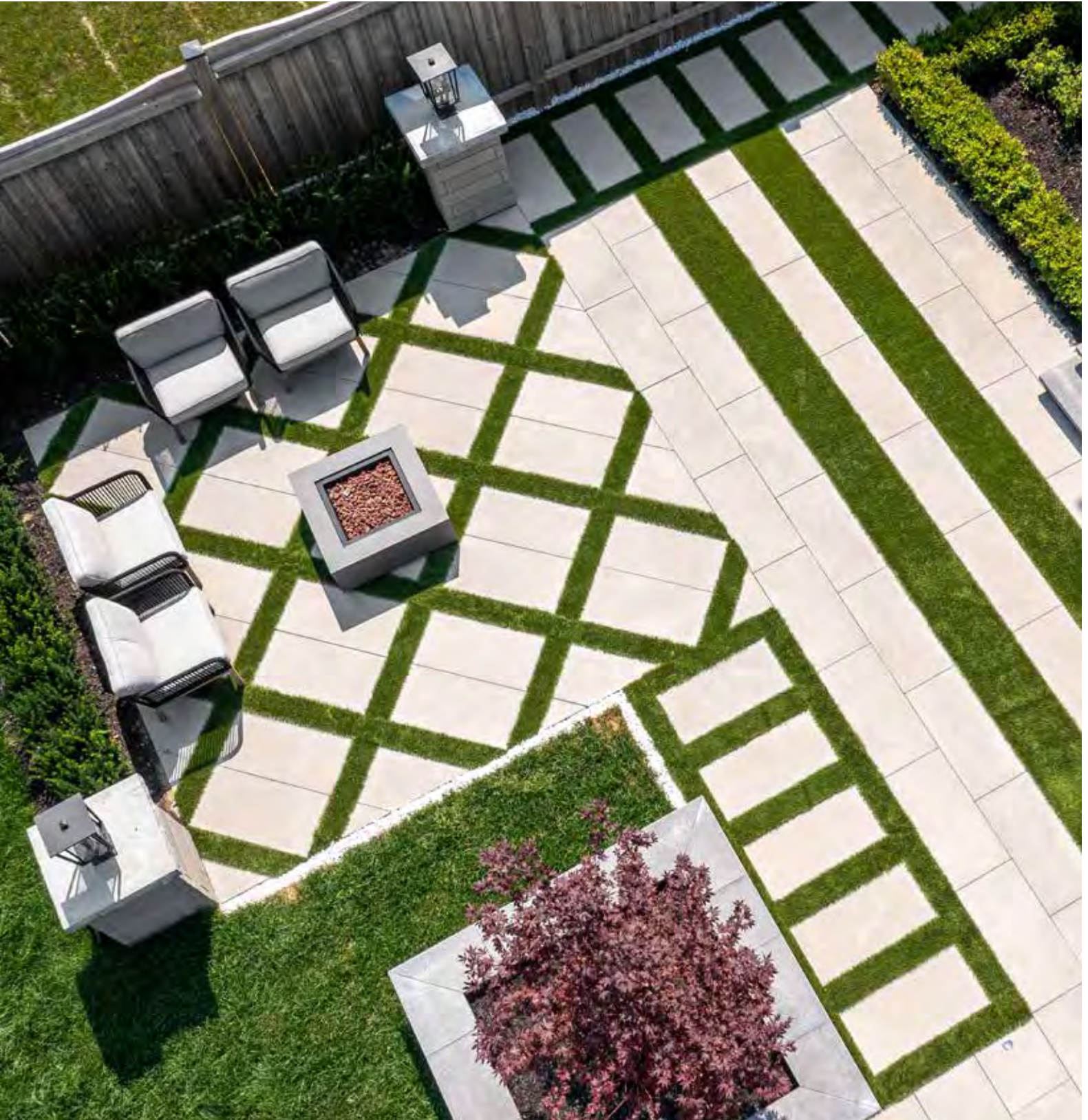



Urban meets suburban. A blending of paver slabs laid in a variety of geometric patterns and contrasted by turf makes this project a visual feast.





Old world charm mingles with modern-day style in this enchanting backyard.



Pavers: Beacon Hill™ Smooth (Granite Mist) and Town Hall™ (Basalt) accent

Vertical Features: Lineo™ Dimensional Stone (Granite Blend) with LedgeStone™ coping and pillar cap (Grey)



Scan here for project video





Clean, granite-like pavers make this ultra-modern pool deck comfortable and cool underfoot on hot, sunny days. Adding to the ambiance of this summer escape is a soothing water feature.

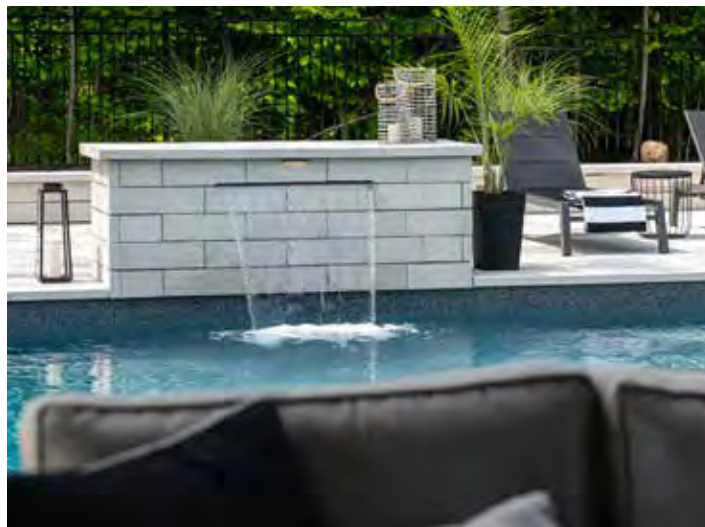

Pavers: Umbriano® with Umbriano coping (Grenada White)

Water Feature and wall: U-Cara® Umbriano with Umbriano coping (Grenada White)



Scan here for project video



Driveway Pavers: Series™ (Black Granite) with Series custom color blend and rounded inlays

Patio Pavers: Beacon Hill™ Smooth (Granite Mist) with Series (Black Granite) accent

Wall: U-Cara® Smooth (Opal Blend) with U-Cara Series (Black Granite) accents

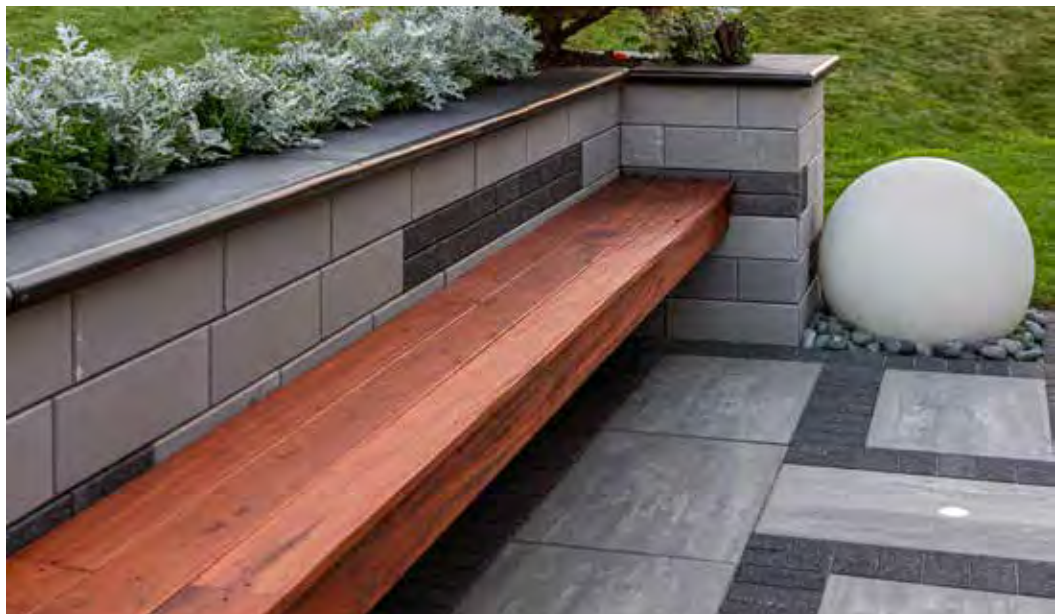



An array of grey and black pavers in the driveway and backyard creates a super sleek, ultra-modern geometric playground.



Beacon Hill™ Smooth (Fossil) with
Natural Stone coping





This gorgeous backyard invites neighbor envy. The linear design of this contemporary pool deck evokes a feeling of tranquility.





Richcliff® (Dawn Mist and Pebble Taupe) with Courtstone® (Basalt accent and LedgeStone™ (Buff) step treads





This Arts and Crafts-style home features the strikingly detailed riven texture of Richcliff, delivering classic elegance.



An ultra-modern, dazzling summer getaway pairs a sparkling pool with sleek Umbriano slabs.



Umbriano® (Winter Marvel)





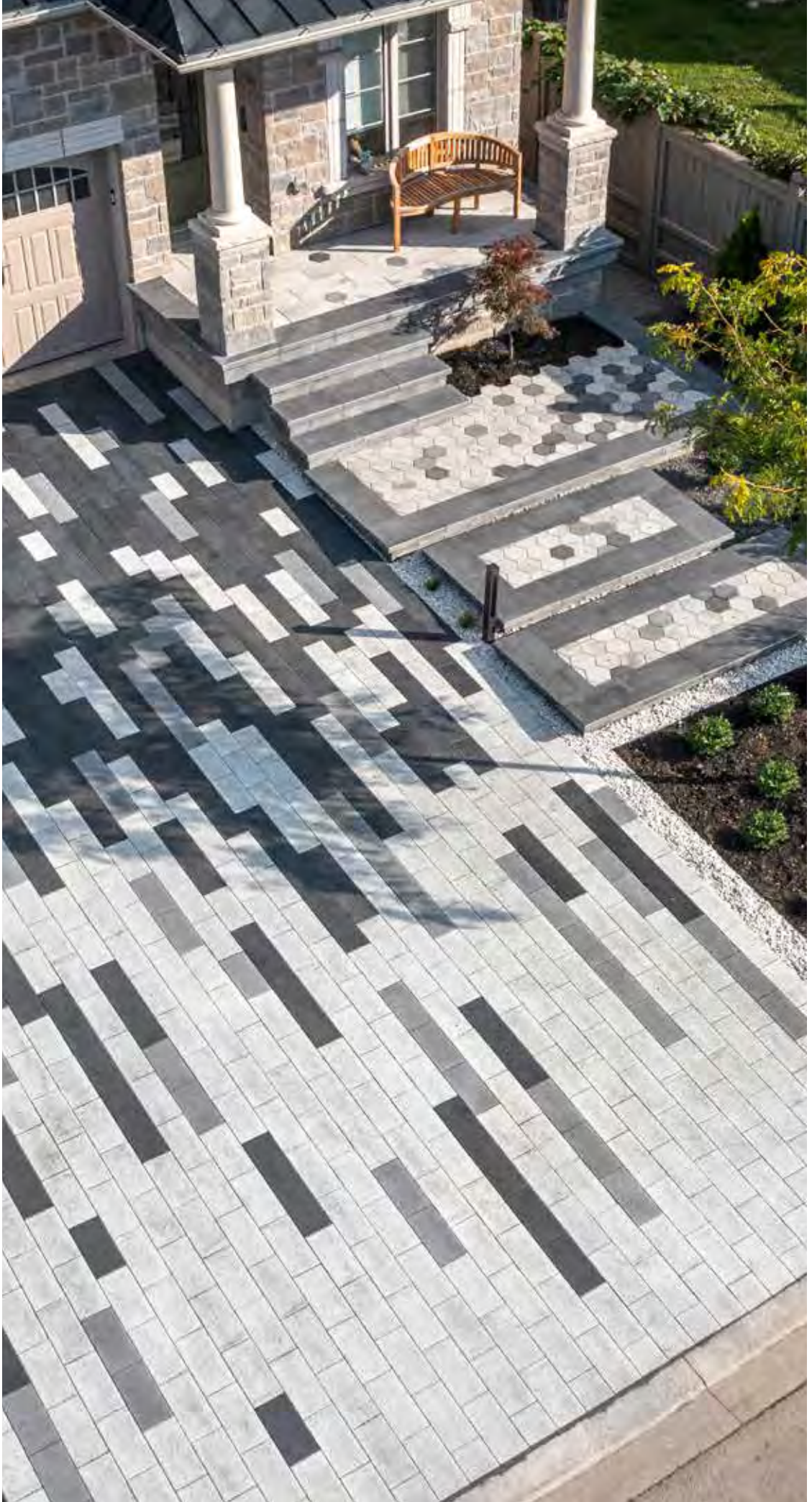

Pavers: Series™
(Black Granite, Glacier
and Mountain Mist)

Entryway and Steps:
Umbriano® (Winter
Marvel) with Umbriano
Hex (Midnight Sky and
French Grey) accents
with Umbriano coping
(Midnight Sky)



Scan here for
project video



Hexagons and rectangles in contrasting color comes to life in this jaw-dropping, pixel perfect design.

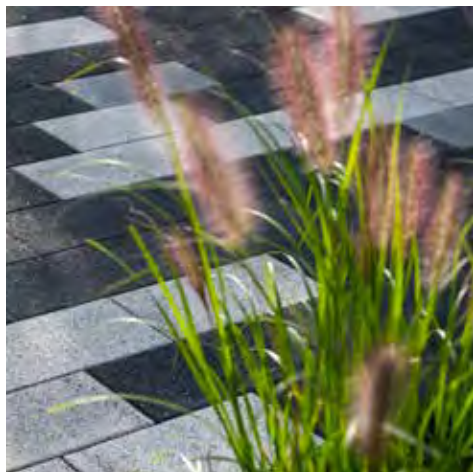



Pavers: Urban™ (Indiana Buff) with Cophorne® (Basalt) paver rug

Garden Walls and Steps: U-Cara® Smooth (Indiana Buff) with Urban (Indiana Buff) Coping and step treads



Scan here for project video





This urban oasis features an elegant pool deck with paver slabs that stay cool and comfortable, and an adjacent seating area offset by a distinctive herringbone paver rug.





Pavers: Beacon Hill™ Smooth (Opal Blend) with Hollandstone™ Premier (Dark Charcoal) accent

Fire Feature and Raised Patio: Lineo™ Dimensional Stone (Charcoal) with Universal coping (Light Grey) and steps

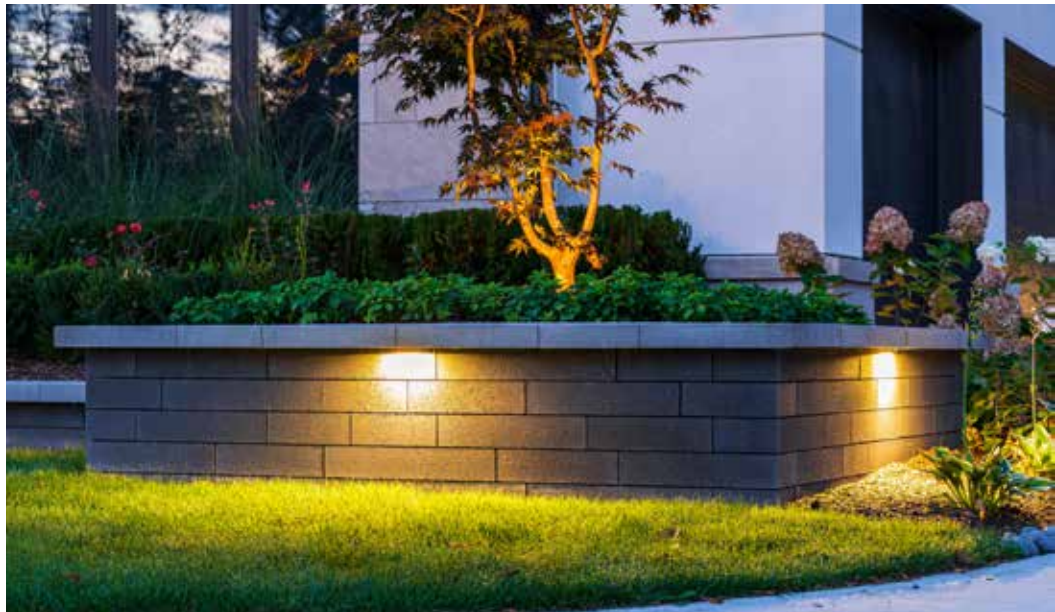



This elevated backyard patio raises the bar with a stunning fire feature, lounge seating and feature lighting at night.



Scan here for
project video



Pavers: Beacon Hill™ Smooth (Granite Mist) with Beacon Hill Smooth (Opal Blend) and Cophorne® (Basalt) paver rug and accents

Water Feature: U-Cara® Umbriano® (French Grey and Midnight Sky) with Natural Stone (Stone Cliff Grey) coping





This modest pool deck makes a big splash, with a distinctive paver rug, water feature, and lighting for cozy vibes.



Pavers: Copthorne® (Basalt)
with Richcliff® (Dawn Mist)
and Beacon Hill™ Smooth
(Opal Blend) border

Step Treads: Natural Stone
(Stone Cliff Grey)





A gently curved walkway brings visitors to the front entrance with Copthorne pavers laid in a traditional herringbone pattern.

Whole home versatility.
The subtle surface detail
of Umbriano works
beautifully from front
entrance to backyard.



Umbriano® pavers
with U-Cara® Wall and
Umbriano step treads
(Summer Wheat)



Scan here for
project video





Richcliff® (Dawn Mist) with Copthorne® (Basalt) paver rug and Courtstone® (Basalt) accents and Natural Stone (Stone Cliff Grey) slabs





A blending of natural stone and historic brick textures laid in a variety of patterns makes this project a visual feast.



County Wide Landscaping **Best in Show Winner**



“The homeowners envisioned a modern, outdoor sanctuary.”

The scope of this 2,400 sqft residential project presented a number of challenges, one of which was elevation. “There was a lot of grading that had to go into this to make the project work,” says Brian Larson, President of County Wide Landscaping. “That’s why it’s a three-level patio.”

The finished space features a monochromatic pool deck in a beautiful mosaic-like geometric design, with square paver slabs interspersed with zigzagging lines of artificial turf. A putting green lies adjacent to the space, along with a breathtaking waterfall cascading from the roof of a shaded pergola.



The pergola was built using Lineo™ Dimensional Stone, topped with Ledgestone™ pillar caps in a grey hue to complement the minimalistic design of the backyard space. Patio lighting was installed under the pillar caps on the patio, creating a soothing ambiance that helps guide visitors at night.

On the upper deck an outdoor kitchen was designed using Lineo™ Dimensional Stone, complete with a grill, bar island and granite countertop, with bar stools to accommodate multiple guests. Finally, nestled towards the rear of the yard, an enclosed seating area features a cozy fire pit, allowing guests to relax and unwind on crisp summer nights.

The result is a stunning outdoor space that transformed this backyard into a haven that will be enjoyed for years to come.



“Unilock provided the sleek, modern look we needed to achieve this extravagant design”

Brian Larsen

PRESIDENT OF COUNTY WIDE
LANDSCAPING



Scan here for
project video



Products

Capture the eye with
exclusive products

From weathered cobblestone to contemporary linear, our product selection reaches beyond the horizontal to include garden walls, pillars, steps, fire tables and fountains. Rock the look that is unmistakably you, and undeniably Unilock!



Unilock Product Categories

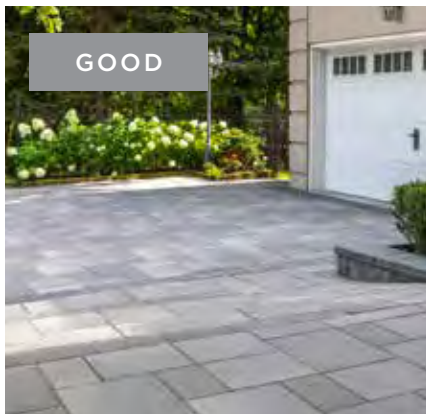

CLASSIC

Our **budget-friendly** Classic products are manufactured to exceed ASTM standards for quality and strength.



ENDURACOLOR™

The refined look of our EnduraColor products is achieved with a two-step manufacturing process that uses concentrated color and **wear-resistant** finer aggregates to protect the surface from the appearance of fading over time.

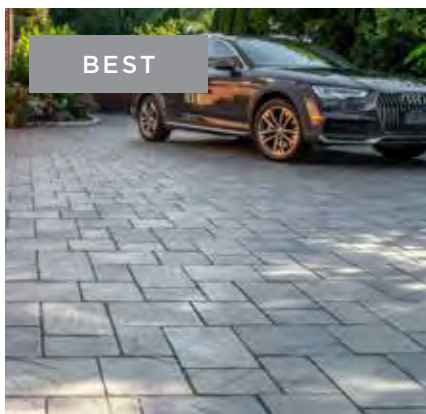

ELEGANCE™

Our Elegance collection offers timeless beauty with styles you can't get anywhere else. From the classic luxury of riven natural stone slabs to the timeworn look of European cobblestones, the look you purchase is **the look that will last.**

Project Cost

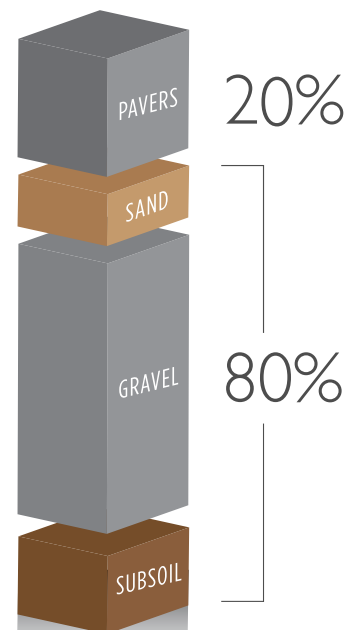

Choose the product you love to get the maximum enjoyment from the investment you've made below the surface.

Don't Compromise

Many products look great when they're first installed, but after time the difference in quality shows.

In an average project, only 20% of the overall cost comes from the paver and wall products you choose, so don't be tempted to compromise.



Think Green



More and more households are opting for permeable paver projects as a sustainable, cost-effective and environmentally friendly alternative to traditional pavers.

Developed in response to growing concerns around stormwater management, permeable pavers allow rainwater to flow between the joints of pavers and back into the subsoil. This provides a dual "green" benefit: by naturally filtering out pollutants before stormwater reaches waterways, and by providing extra moisture back into surrounding plant material.

Using permeable pavers will decrease rainwater puddling on the pavement, effectively reducing the risk of ice buildup which is a benefit particularly useful on driveways.

For homeowners who live in regions where local codes require them to reduce impervious surfaces on their lot to accommodate a new landscape feature like an in-ground pool, permeable paving is a popular alternative to conventional poured-in-place concrete or asphalt.



Some homeowners install rainwater collection systems underneath their paver projects to supply water to in-ground sprinkler systems!

Permeable Pavers

Special materials are used in the joints and in the permeable base below, to encourage water to flow through and reach the subsoil.

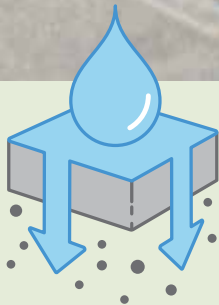

Permeable pavers look similar to traditional pavers but are designed with special spacer bars that create a wider joint.

Permeable Collection

In 1991, Unilock introduced the first permeable paver to North America. Since then, we've worked to produce the most extensive collection of permeable pavers in the industry.

TOWN HALL'



ECO-PRIORA™ PREMIER

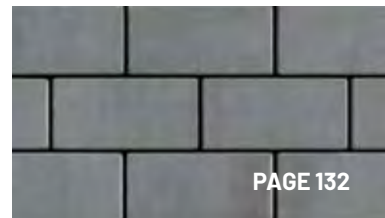

TREO' SMOOTH



ECO-PROMENADE'



TRIBECA COBBLE'



NORDIC COBBLE'

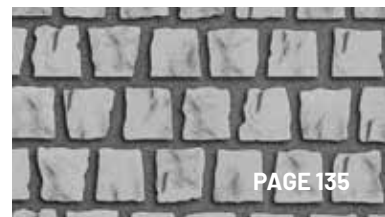

Ultima™



Courystone

Only Unilock has the technology in North America to manufacture Ultima Concrete resulting in pavers **up to four times stronger** than poured concrete. With Ultima, the look you purchase is the look that will last.

Exclusive to **UNILOCK**

 **ELEGANCE**™

Ultima Concrete is a key ingredient in the **timeless beauty** of our Elegance collection of premium pavers.

What makes Ultima concrete so strong?

In a word, fluidity. During manufacturing, we use as little water as possible while enhancing the fluidity at the drying stage, resulting in a form that self-compacts at the chemical level. The result is an extraordinary product that is unlike anything you'll find outside of Unilock.

With Ultima

Unilock Town Hall pavers are built to last



Without Ultima

Deteriorating brick pavers exposed to deicing salts

Reala™

When it comes to creating **realistic textures** that are indistinguishable from brick, cobblestone, or flagstone, there is no room for compromise.

Any paver meant to imitate a classic building material needs to embody its look, its feel, and its strength.

At Unilock, we've been capturing all three since 2004 with our Reala technology.



How do we achieve a random appearance?

First, we cast a multitude of pavers from molds of actual flagstone, brick, and cobblestone. Then we randomize the casting process. With so much variation between molds, we can then ensure that any paver installation avoids repetition, no matter how large or small the project.

Utilizing REALA technology, a multitude of natural stone surfaces, brick and historic cobblestones are cast to create a wide variety of **authentic textures** with consistent dimensions that are more cost efficient to install.



EasyClean™



Integral Stain Resistance



Ketchup

Motor Oil

Red Wine

BEFORE



AFTER

Stains set for thirty minutes, then removed with damp paper towel, hand scrub brush and mild soap.

What does this mean for stains?

Any spill that does manage to land on an EasyClean paver can be quickly and easily wiped away - no deep scrubbing or heavy cleaners needed.

Exclusive to **JNIOCK**

Unlike after-market sealers which merely coat the top, EasyClean goes beyond the surface and becomes integral to the product during manufacturing. The result is enhanced surface color, and stain resistance.

EASYSKLEAN ADVANTAGES

Pavers are pre-sealed at the factory

Enhanced resistance to weathering

Reduced dirt absorption

Stains from leaves, coffee, ketchup, mustard, wine and BBQ oils are easier to remove

See how
it works



ColorFusion™

Exclusive to **UNILOCK**

The look of natural granite is achieved when color and granite particles are randomly dispersed using proprietary ColorFusion technology to achieve a unique mottled surface.



ColorFusion also available on our U-Cara® Multi-Face Wall System.

ColorFusion is made with the same durable concrete and fortifying manufacturing processes that make Unilock pavers last for decades. Our commitment to beautiful, long-lasting hardscaping products is what built our reputation, and we honor that commitment through continued innovation.

Sustainability Commitment



In 2021, Unilock announced its commitment to becoming a carbon neutral company.

We have implemented initiatives that continue to minimize our use of fossil fuels, conserve water and replace cement in our products, while producing the highest quality product.



Learn
More

How can you make your project more sustainable?

Make it Permeable

Permeable pavers allow rainwater to flow through the pavement surface and back into the subsoil below, filtering out contaminants that could otherwise flow into stormwater drains and pollute local waterways.

Shop Locally

Choosing products that are manufactured at a Unilock facility close to your home reduces carbon emissions associated with transportation.

Think Lighter

Products that are lighter in color, have a higher solar reflectance. When you choose a lighter colored product, more of the sun's energy is reflected and less heat is absorbed into the pavement surface. This helps reduce urban 'heat island effect' and carries a number of environmental benefits.



EcoTerra™



Paving a Greener Way



**EFFLORESCENCE
FREE**



**UP TO 15%
REDUCTION IN CO₂**

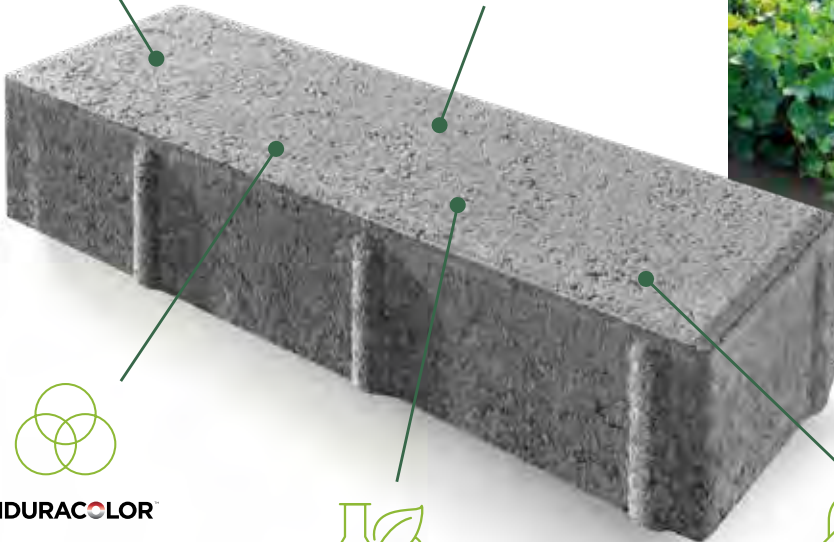

Learn
More



ENDURACOLOR



**CEMENT-FREE
FACE-MIX**



**COLOR STAYS
TRUE LONGER**

Revolutionary EcoTerra technology offers a sustainable paving solution with its cement-free face-mix. It provides high compressive strength, low absorption, and remarkable colorfastness, all while contributing up to a 15% reduction in carbon dioxide emissions. Additionally, EcoTerra products are designed to be free of efflorescence.



**2020 winner
Innovative
Product**





Collections

Unilock Collections streamline the product selection process by offering pavers, walls, steps and coping that will work well together to enhance any outdoor space.



The modern look of granite is now available across pavers, walls, coping and steps.

You can achieve a modern monochromatic design by combining these products together for the ultimate contemporary look.



Exclusive to **JNIOCK**

Umbriano[®]

COLLECTION

Sleek, modern look of granite





PATIOS & POOL DECKS



ENTRANCES & DRIVEWAYS



Umbriano®
COLLECTION



VERTICAL FEATURES



STEPS & COPING



FRENCH GREY



GRENADA WHITE



SUMMER WHEAT

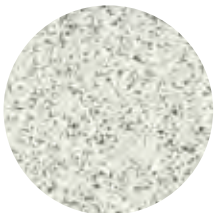

WINTER MARVEL

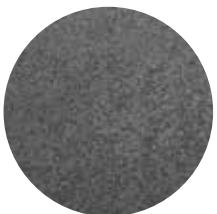

MIDNIGHT SKY

7x14, 8x16, 8x24, 18x36,
Wall and Copings only



COLORFUSION™
Subtly mottled color finish

 **EasyClean**
Factory sealed for
integral stain resistance



Umbriano® COLLECTION

3 UNIT RANDOM BUNDLE

See page 117 for product details

60mm - Pedestrian only
80mm - Drive Friendly



AVAILABLE IN
60MM & 80MM

// **Large Rectangle** - 14¼ x 21½ x 2⅜" 360 x 540 x 60mm

// **Square** - 14¼ x 14¼ x 2⅜" 360 x 360 x 60mm

// **Small Rectangle** - 7 x 14¼ x 2⅜" 180 x 360 x 60mm

PAVER & SLAB

See pages 117-119 for product details

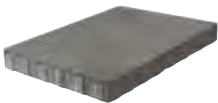

New 18 x 36
17¾ x 35½ x 2⅜"
450 x 900 x 60mm

18 x 36
17¾ x 35½ x 3⅞"
450 x 900 x 100mm



7 x 14 x 2⅜"
180 x 360 x 60mm

7 x 14 x 3⅞"
180 x 360 x 80mm



8 x 16
7⅞ x 15¾ x 2¾"
200 x 400 x 70mm

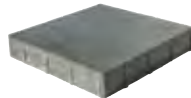

16 x 16
15¾ x 15¾ x 2¾"
400 x 400 x 70mm

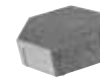

Hex
7⅞ x 7⅞ x 2¾"
200 x 200 x 70mm



12 x 24
11⅞ x 23⅝ x 2¾"
300 x 600 x 70mm



8 x 24
7⅞ x 23⅝ x 2¾"
200 x 600 x 70mm

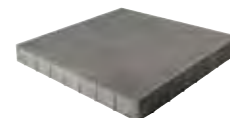

36 x 36
35½ x 35½ x 3⅞"
900 x 900 x 100mm

WALL AND STEP

See page 159 for product details



// **U-Cara**
Umbriano Fascia Panel 5⅞ x 18⅜ x 2⅜"
150 x 466 x 60mm

// **U-Cara Corner**
Umbriano Closed-end Panel 5⅞ x 20⅞ x 2⅜"
150 x 530 x 60mm

COPING

See page 183 for product details



// **Umbriano Bullnose**
14 x 24 x 2⅜"
360 x 600 x 60mm



// **Umbriano Chamfered**
14 x 24 x 2⅜"
360 x 600 x 60mm



Available in smooth or flagstone textures, the Beacon Hill Collection offers a monochromatic color palette that brings a relaxed vibe to any outdoor project.

ENDURACOLOR™

Beacon Hill™

COLLECTION

From contemporary to traditional, this collection has something for everyone





PATIOS & POOL DECKS



ENTRANCES & DRIVEWAYS



Beacon Hill™
COLLECTION



VERTICAL FEATURES



STEPS & COPING

SMOOTH



ALMOND GROVE
Excluding Slab



FOSSIL



GRANITE MIST



OPAL BLEND



DARK BROWN
7x14 only



DARK CHARCOAL
7x14 only

FLAGSTONE RANDOM



ALMOND GROVE



FOSSIL

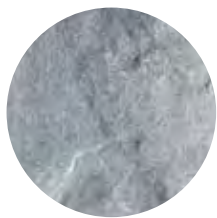

GRANITE MIST

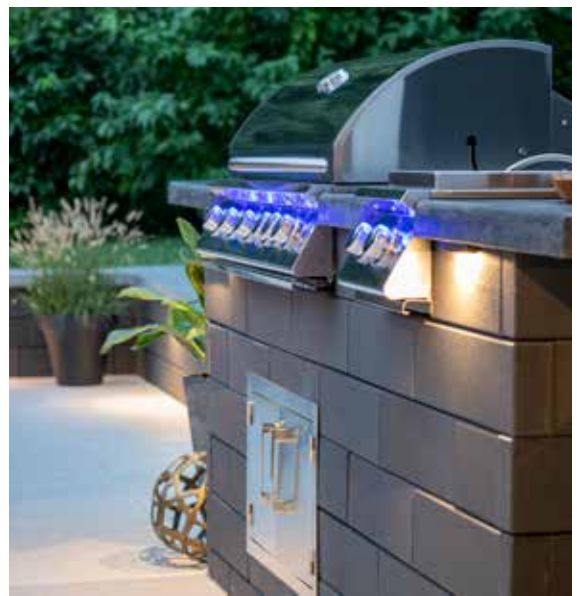

Beacon Hill™ COLLECTION

3 UNIT RANDOM BUNDLE

See page 91 & 95 for product details

60mm - Pedestrian only
80mm - Drive Friendly



Smooth



Flagstone

AVAILABLE IN
60MM & 80MM

// **Large Rectangle** - 15 x 22½ x 2¾" 380 x 570 x 60mm

// **Square** - 15 x 15 x 2¾" 380 x 380 x 60mm

// **Small Rectangle** - 7½ x 15 x 2¾" 190 x 380 x 60mm

PAVER & SLAB

See page 93 for product details

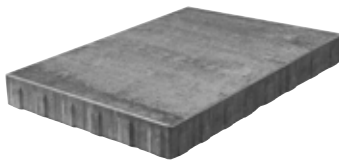

22½ x 37½ x 2¾"
570 x 950 x 60mm

Smooth only



7½ x 15 x 2¾"
190 x 380 x 60mm

Smooth only

7½ x 15 x 3⅛"
190 x 380 x 80mm

WALL AND STEP

See page 159 for product details



// **U-Cara**
Smooth and Pitched Fascia Panel

5⅞ x 18¾ x 2¾"
150 x 466 x 60mm

// **U-Cara Corner**
Smooth and Pitched Closed-end Panel

5⅞ x 20⅞ x 2¾"
150 x 530 x 60mm

COPING

See page 183 for product details



// **Beacon Hill Bullnose**

14 x 24 x 2¾"
360 x 600 x 60mm

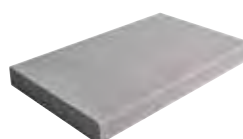

// **Beacon Hill Chamfered**

14 x 24 x 2¾"
360 x 600 x 60mm



Step up your outdoor game with the bold and stylish Urban Collection. Urban pavers, slabs and coping are manufactured with EnduraColor™, providing a refined surface that resists the appearance of fading over time.



ENDURACOLOR™

Urban™

COLLECTION

Out with the old, in with the Urban!





INDIANA BUFF



STERLING



DARK CHARCOAL
Wall and Coping only

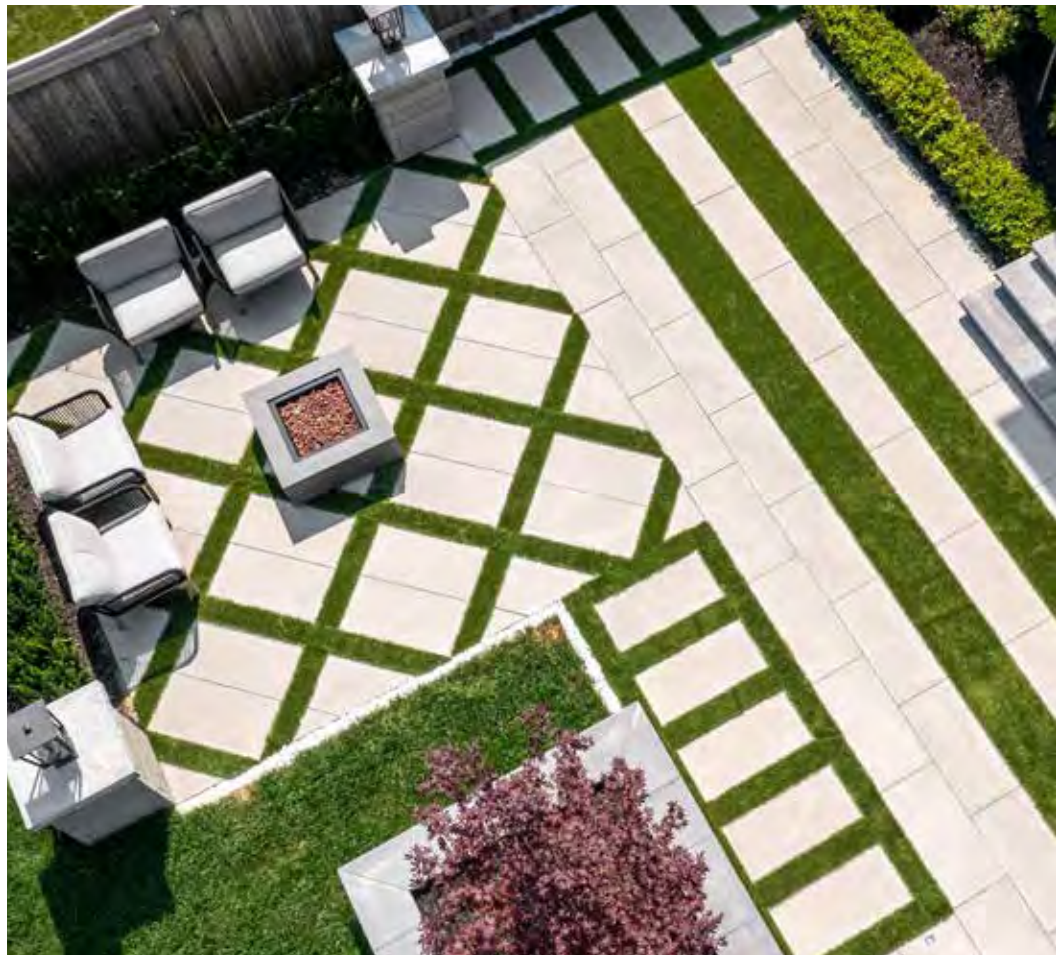

Urban™ COLLECTION

3 UNIT RANDOM BUNDLE

See page 105 for product details



- // Large Rectangle - 15 x 22½ x 2⅜" 380 x 570 x 60mm
- // Square - 15 x 15 x 2⅜" 380 x 380 x 60mm
- // Small Rectangle - 7½ x 15 x 2⅜" 190 x 380 x 60mm

SLAB

See page 119 for product details

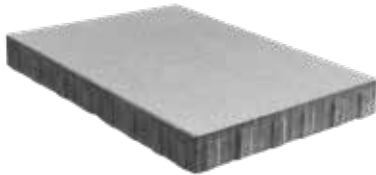

// 18 x 24
17¾ x 23⅝ x 2⅜"
450 x 600 x 60mm

// 18 x 36
17¾ x 35½ x 3⅝"
450 x 900 x 60mm

New Thickness // 18 x 36
17¾ x 35½ x 4"
450 x 900 x 100mm

Ask us about our base stabilization systems for driveway installation

WALL AND STEP

See page 159 for product details



// U-Cara
Smooth Fascia Panel 5⅞ x 18⅜ x 2⅜"
150 x 466 x 60mm

// U-Cara Corner
Smooth Closed-end Panel 5⅞ x 20⅞ x 2⅜"
150 x 530 x 60mm

COPING

See page 182 for product details

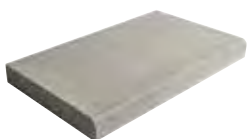

// Urban Bullnose
19 x 35½ x 2⅜"
485 x 900 x 60mm

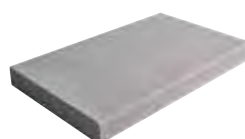

// Urban Chamfered
19 x 35½ x 2⅜"
485 x 900 x 60mm



The gentle surface texture of Windermere evokes a relaxing appearance that's suitable for driveway, walkway, or patio applications.

CLASSIC

Windermere™

COLLECTION

Classic look with budget-friendly appeal



SMOOTH



DUSK



SAFARI



GRANITE BLEND



CLIFFSIDE GREY

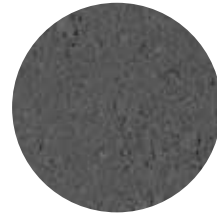

CHARCOAL

*Available in 7x14,
Wall, Coping and Step only*

FLAGSTONE



DUSK



SAFARI

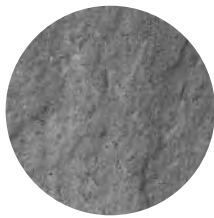

GRANITE BLEND

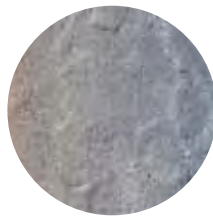

CLIFFSIDE GREY



CLASSIC

Windermere™

COLLECTION

3 UNIT RANDOM BUNDLE

See page 98-101 for product details



Smooth



Flagstone

SMOOTH & FLAGSTONE



// **Small Rectangle**
Smooth only

// **Large Rectangle** - 14 x 21 x 2³/₄" 380 x 540 x 70mm

// **Square** - 14 x 14 x 2³/₄" 360 x 360 x 70mm

// **Small Rectangle** - 7 x 14 x 2³/₄" 180 x 360 x 70mm

WALL

See page 165 & 169 for product details

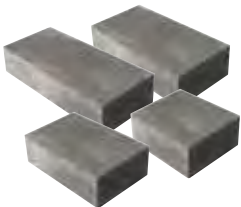

// **Lineo™ Dimensional Smooth**
Random Bundle



// **Pisa™ Smooth Standard / Corner**
10⁷/₈ x 21³/₄ x 3³/₈"
275 x 550 x 85mm

COPING

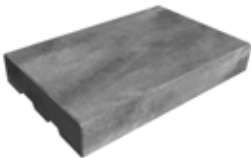

// **Pisa™ Smooth**
13⁷/₈ x 21³/₄ x 3³/₈"
350 x 550 x 85mm



COMING SOON
**Pisa Smooth Jumper
Standard / Corner**
10⁷/₈ x 21³/₄ x 6²/₃"
275 x 550 x 170mm

STEP

See page 185 for product details



// **SienaStone™ Smooth
48" Step**
20 x 47¹/₄ x 7"
500 x 1200 x 180mm



// **SienaStone Smooth
72" Step**
20 x 70³/₄ x 7"
500 x 1800 x 180mm



The Metro Collection appeals to homeowners who seek a clean, modern look. Available in three contemporary hues for a sleek, outdoor space.

CLASSIC

Metro™

COLLECTION

Upgrade your outdoor space with this cost-efficient collection





DUSK



SAFARI



CHARCOAL

Excluding Random



ClassicCoat

Factory sealed to protect surface texture and color



CLASSIC

Metro™ COLLECTION

3 UNIT RANDOM BUNDLE

See page 103 for product details



// **Large Rectangle** - 10 x 15 x 2¾" 250 x 375 x 70mm

// **Square** - 10 x 10 x 2¾" 250 x 250 x 70mm

// **Small Rectangle** - 5 x 10 x 2¾" 125 x 250 x 70mm



// **Small Rectangle**

Charcoal only

SLAB

See page 103 for product details



15 x 29⅞ x 2¾"
380 x 760 x 60mm



New
17¾ x 35½ x 3⅞"
450 x 900 x 100mm

WALL

See page 165 & 169 for product details

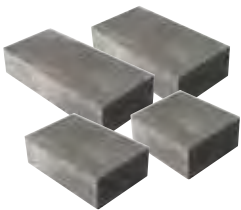

// **Lineo™ Dimensional Smooth**

Random Bundle



// **Pisa™ Smooth Standard / Corner**

10⅞ x 21¾ x 3⅞"
275 x 550 x 85mm

COPING

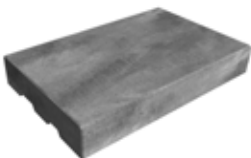

// **Pisa™ Smooth**
13⅞ x 21¾ x 3⅞"
350 x 550 x 85mm



COMING SOON
Pisa Smooth Jumper
Standard / Corner

10⅞ x 21¾ x 6⅔"
275 x 550 x 170mm

STEP

See page 185 for product details



// **SienaStone™ Smooth**
48" Step
20 x 47¼ x 7"
500 x 1200 x 180mm



// **SienaStone Smooth**
72" Step
20 x 70¾ x 7"
500 x 1800 x 180mm





Pavers & Slabs

From traditional shapes and textures to the most advanced technology and unique styles, the choices available in our paver collection are unrivaled in the industry.



PRODUCT PAIRINGS



Pool & Wall Coping

Beacon Hill™ Coping
See page 183

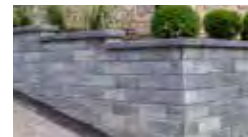

Walls

U-Cara® Smooth
See page 159

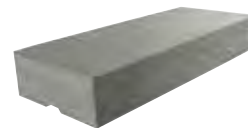

Steps

SienaStone™ Smooth
See page 185

TOP Opal Blend with Mattoni™ (Dark Charcoal) accent

BOTTOM Almond Grove with Dark Charcoal accent

Color selection should be chosen from actual samples.

Beacon Hill™ Smooth



ALMOND GROVE

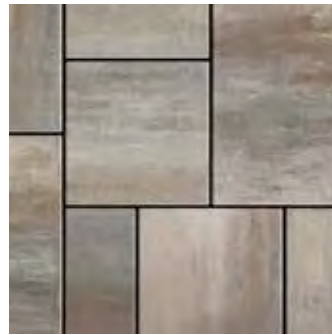

FOSSIL



GRANITE MIST



OPAL BLEND

3 UNIT RANDOM BUNDLE AVAILABLE IN BOTH 60MM & 80MM

60mm not suitable for vehicular applications. 80mm can handle vehicular loads.



LARGE RECTANGLE
15 x 22½ x 2⅜ (3⅞)"
380 x 570 x 60 (80)mm

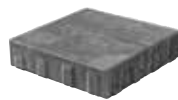

SQUARE
15 x 15 x 2⅜ (3⅞)"
380 x 380 x 60 (80)mm



SMALL RECTANGLE
7½ x 15 x 2⅜ (3⅞)"
190 x 380 x 60 (80)mm

SMALL RECTANGLE AVAILABLE IN BOTH 60MM & 80MM



DARK BROWN

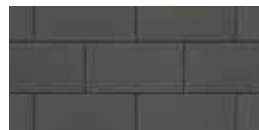

DARK CHARCOAL



OPAL BLEND



7½ x 15 x 2⅜ (3⅞)"
190 x 380 x 60 (80)mm

SLAB PEDESTRIAN ONLY

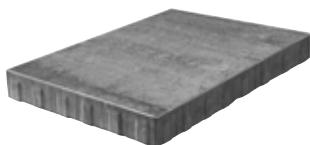

22½ x 37½ x 2⅜"
570 x 950 x 60mm

Fossil, Granite Mist
and Opal Blend Only
See page 93



Color selection should be chosen from actual samples.

Fossil

Beacon Hill™ Smooth Slab



OPAL BLEND



GRANITE MIST



FOSSIL

INDIVIDUAL UNIT PEDESTRIAN ONLY



22½ x 37½ x 2⅜"
570 x 950 x 60mm



PRODUCT PAIRINGS



Pool & Wall Coping

Beacon Hill™ Coping
See page 183



Walls

U-Cara® Pitched
See page 159



Steps

SienaStone™ Smooth
See page 185

TOP Granite Mist with Copthorne® (Basalt) accent

BOTTOM Granite Mist with Copthorne (Basalt) and Beacon Hill Smooth (Opal Blend) accents.
U-Cara Pitched (Granite Mist) retaining wall with Opal Blend accent and Natural Stone coping and steps.

Beacon Hill™ Flagstone



ALMOND GROVE



FOSSIL



GRANITE MIST

3 UNIT RANDOM BUNDLE AVAILABLE IN BOTH 60MM & 80MM

60mm not suitable for vehicular applications. 80mm can handle vehicular loads.



LARGE RECTANGLE
15 x 22½ x 2⅜ (3⅛)"
380 x 570 x 60 (80)mm



SQUARE
15 x 15 x 2⅜ (3⅛)"
380 x 380 x 60 (80)mm



SMALL RECTANGLE
7½ x 15 x 2⅜ (3⅛)"
190 x 380 x 60 (80)mm



PRODUCT PAIRINGS



Pool & Wall Coping

Beacon Hill™ Coping
See page 183



Walls

U-Cara Pitched
See page 159



Steps

SienaStone™ Smooth
See page 185

TOP Fossil with Town Hall® (Basalt) accent

BOTTOM Granite Mist

Color selection should be chosen from actual samples.



Northshore™



FOSSIL



GRANITE MIST



STERLING

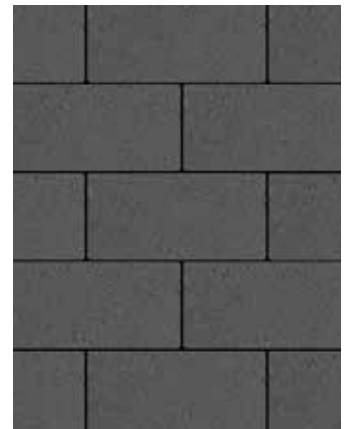

DARK CHARCOAL
Small Rectangle only

3 UNIT RANDOM BUNDLE DRIVE FRIENDLY



LARGE RECTANGLE
17³/₄ x 11⁷/₈ x 2³/₄"
450 x 300 x 70mm



SQUARE
11⁷/₈ x 11⁷/₈ x 2³/₄"
300 x 300 x 70mm



SMALL RECTANGLE
5⁷/₈ x 11⁷/₈ x 2³/₄"
150 x 300 x 70mm

SMALL RECTANGLE DRIVE FRIENDLY



5⁷/₈ x 11⁷/₈ x 2³/₄"
150 x 300 x 70mm
Dark Charcoal only



PRODUCT PAIRINGS



Pool & Wall Coping

Pisa™ Smooth
See page 169



Walls

Pisa Smooth
See page 169



Steps

SienaStone™ Smooth
See page 185

TOP Safari

BOTTOM Cliffside Grey

Color selection should be chosen from actual samples.

CLASSIC

Windermere™ Flagstone



SAFARI **NEW**



DUSK **NEW**



GRANITE BLEND



CLIFFSIDE GREY

3 UNIT RANDOM BUNDLE DRIVE FRIENDLY



LARGE RECTANGLE
14 x 21 x 2³/₄"
360 x 540 x 70mm



SQUARE
14¹/₁₆ x 14¹/₁₆ x 2³/₄"
360 x 360 x 70mm



SMALL RECTANGLE
7 x 14 x 2³/₄"
180 x 360 x 70mm



PRODUCT PAIRINGS



Pool & Wall Coping

Pisa™ Smooth
See page 169



Walls

Pisa Smooth
See page 169



Steps

SienaStone™ Smooth
See page 185

TOP Granite Blend

BOTTOM Cliffside Grey with Charcoal accent

Color selection should be chosen from actual samples.

CLASSIC

Windermere[™] Smooth

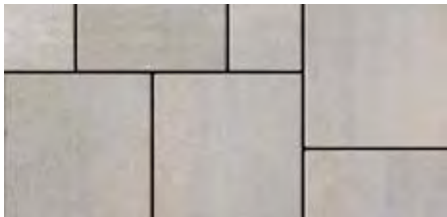

SAFARI **NEW**

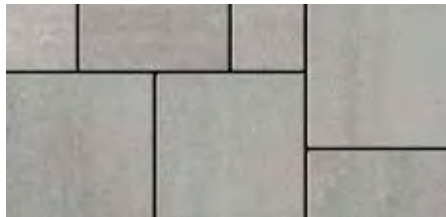

DUSK **NEW**



CLIFFSIDE GREY

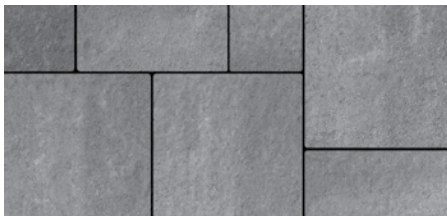

GRANITE BLEND



CHARCOAL Small Rectangle only

3 UNIT RANDOM BUNDLE DRIVE FRIENDLY



LARGE RECTANGLE
14 x 21 x 2³/₄"
360 x 540 x 70mm



SQUARE
14 x 14 x 2³/₄"
360 x 360 x 70mm



SMALL RECTANGLE
7 x 14 x 2³/₄"
180 x 360 x 70mm

SMALL RECTANGLE DRIVE FRIENDLY



7 x 14 x 2³/₄"
180 x 360 x 70mm
Charcoal only



PRODUCT PAIRINGS



Pool & Wall Coping

Pisa™ Smooth
See page 169

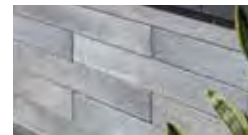

Walls

Pisa Smooth
See page 169



Steps

SienaStone™ Smooth
See page 185

TOP Dusk and Safari (mixed on site) with Charcoal accent

BOTTOM Safari with Copthorne® (Basalt)

Color selection should be chosen from actual samples.

Metro™



SAFARI



DUSK



CHARCOAL

SLABS PEDESTRIAN ONLY

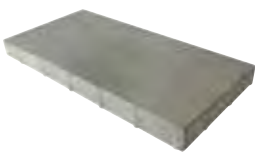

15 x 29⁷/₈ x 2³/₄"
380 x 760 x 60mm



New
17³/₄ x 35¹/₂ x 3⁷/₈"
450 x 900 x 100mm

Ask us about our base stabilization systems for driveway installation

NEW 3 UNIT RANDOM BUNDLE DRIVE FRIENDLY



LARGE RECTANGLE
10 x 15 x 2³/₄"
250 x 375 x 70mm

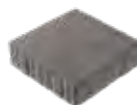

SQUARE
10 x 10 x 2³/₄"
250 x 250 x 70mm



SMALL RECTANGLE
5 x 10 x 2³/₄"
125 x 250 x 70mm



SMALL RECTANGLE
Sold Separately
Charcoal only



PRODUCT PAIRINGS



Pool & Wall Coping

Urban™ Coping
See page 182



Walls

U-Cara® Smooth
See page 159



Steps

U-Cara
See page 159

PHOTOS Indiana Buff

Color selection should be chosen from actual samples.

Urban™



INDIANA BUFF



STERLING



SLABS PEDESTRIAN ONLY

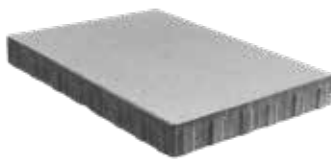

18 x 24
 $17\frac{3}{4} \times 23\frac{5}{8} \times 2\frac{3}{8}$ "
 450 x 600 x 60mm

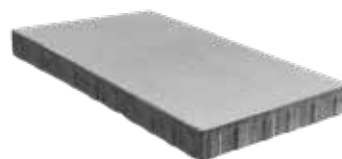

18 x 36
 $17\frac{3}{4} \times 35\frac{1}{2} \times 3\frac{3}{8}$ "
 450 x 900 x 60mm

New Thickness
 $17\frac{3}{4} \times 35\frac{1}{2} \times 4$ "
 450 x 900 x 100mm

Ask us about our base stabilization systems for driveway installation

NEW 3 UNIT RANDOM BUNDLE PEDESTRIAN ONLY



LARGE RECTANGLE
 $15 \times 22\frac{1}{2} \times 2\frac{3}{8}$ "
 380 x 570 x 60mm



SQUARE
 $15 \times 15 \times 2\frac{3}{8}$ "
 380 x 380 x 60mm



SMALL RECTANGLE
 $7\frac{1}{2} \times 15 \times 2\frac{3}{8}$ "
 190 x 380 x 60mm



ENDURACOLOR™

 **comfort step.**
Ultra-smooth surface texture

Urban™ Allure **New**



LINEN BUFF **NEW**

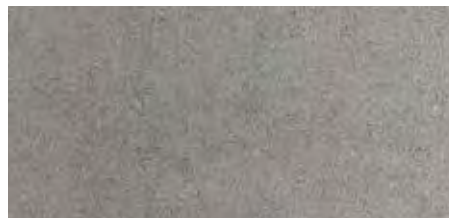

LINEN GREY **NEW**

PEDESTRIAN ONLY

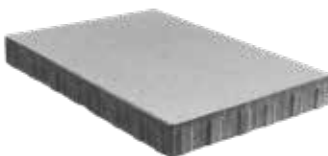

18 x 24
17¾ x 23⅝ x 2⅜"
450 x 600 x 60mm



18 x 36
17¾ x 35½ x 3⅝"
450 x 900 x 60mm

Color selection should be chosen from actual samples.

Linen Grey



ENDURACOLOR™

Skyline™



LIGHT GREY - CLASSIC



OPAL BLEND - SMOOTH PREMIER



GRENADA WHITE - UMBRIANO*

PEDESTRIAN ONLY



24 x 24
23⁵/₈ x 23⁵/₈ x 2"
600 x 600 x 50mm

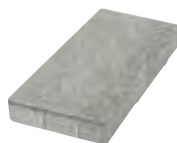

12 x 24
11⁷/₈ x 23⁵/₈ x 2"
300 x 600 x 50mm

Color selection should be chosen from actual samples.

Opal Blend (Smooth Finish)

Bristol Valley®



PRODUCT PAIRINGS



Pool & Wall Coping

BeaconHill™ Coping
See page 183



Pool & Wall Coping

Universal
See page 184



Walls

U-Cara® Pitched
See page 159

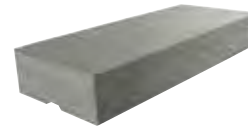

Steps

SienaStone™ Smooth
See page 185



GRANITE FUSION



OAK BROWN FUSION



3 UNIT RANDOM BUNDLE AVAILABLE IN BOTH 60MM & 80MM

60mm not suitable for vehicular applications. 80mm can handle vehicular loads.



LARGE RECTANGLE
15 x 22½ x 2⅜ (3⅛)"
380 x 570 x 60 (80)mm

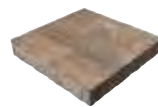

SQUARE
15 x 15 x 2⅜ (3⅛)"
380 x 380 x 60 (80)mm

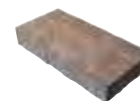

SMALL RECTANGLE
7½ x 15 x 2⅜ (3⅛)"
190 x 380 x 60 (80)mm

Artline™



PRODUCT PAIRINGS



Pool & Wall Coping

Beacon Hill™ Coping
See page 183



Walls

U-Cara® Smooth
See page 159



Steps

SienaStone™ Smooth
See page 185



STERLING

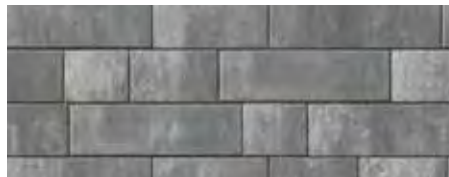

GRANITE MIST



FOSSIL

7 UNIT RANDOM BUNDLE DRIVE FRIENDLY



4⁷/₈ x 7⁵/₈ x 3¹/₈"
125 x 193 x 80mm



4⁷/₈ x 8³/₄ x 3¹/₈"
125 x 219 x 80mm

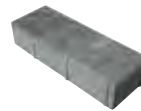

4⁷/₈ x 10¹/₄ x 3¹/₈"
125 x 260 x 80mm

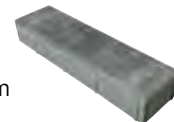

4⁷/₈ x 12 x 3¹/₈"
125 x 305 x 80mm

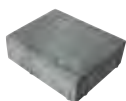

7¹/₂ x 8⁷/₈ x 3¹/₈"
187 x 225 x 80mm

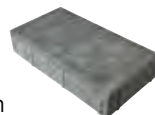

7¹/₂ x 13³/₈ x 3¹/₈"
187 x 338 x 80mm

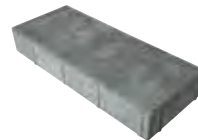

7¹/₂ x 17³/₄ x 3¹/₈"
187 x 450 x 80mm

CLASSIC

Brussels Block®



PRODUCT PAIRINGS



Pool & Wall Coping

Brussels Dimensional
See page 170



Walls

Brussels Dimensional
See page 170



Steps

Natural Stone
See page 187



SANDSTONE



MAHOGANY



COFFEE CREEK



LIMESTONE



CHARCOAL
XL, Standard and Fullnose only

INDIVIDUAL UNITS

DRIVE FRIENDLY

Antiqued Finish



XL STONE
8¼ x 13¾ x 2¾"
208 x 348 x 70mm



STANDARD STONE
6⅞ x 8¼ x 2¾"
173 x 208 x 70mm



HALF STONE
4 x 6⅞ x 2¾"
104 x 173 x 70mm



FULLNOSE COPING
5⅞ x 11⅞ x 2¾"
150 x 300 x 70mm

Color selection should be chosen from actual samples.

Sandstone with Brussels Dimensional Stone® (Sandstone)

CLASSIC

Treo Smooth



PRODUCT PAIRINGS



Pool & Wall Coping

Pisa™ Smooth
See page 169



Walls

Pisa Smooth
See page 169



Steps

SienaStone™ Smooth
See page 185



GRANITE BLEND

3 UNIT RANDOM BUNDLE PERMEABLE DRIVE FRIENDLY



LARGE RECTANGLE
9¼ x 13¾ x 3⅛"
233 x 349 x 80mm



SQUARE
9¼ x 9¼ x 3⅛"
233 x 233 x 80mm



SMALL RECTANGLE
4⅝ x 9¼ x 3⅛"
116 x 223 x 80mm

Color selection should be chosen from actual samples.

Granite Blend with Cophthorne® (Basalt) accent



CLASSIC

Hollandstone™



GRANITE



CHARCOAL



NATURAL



SIERRA

INDIVIDUAL UNITS DRIVE FRIENDLY



4 x 8
 $3\frac{7}{8} \times 7\frac{7}{8} \times 2\frac{3}{8}$ "
 100 x 200 x 60mm



8 x 8
 $7\frac{7}{8} \times 7\frac{7}{8} \times 2\frac{3}{8}$ "
 200 x 200 x 60mm

Not available in Sierra

Granite with Cophorne® (Basalt) accent



ENDURACOLOR™

Holland Premier™ **New**



GRANITE MIST



DARK CHARCOAL



OPAL BLEND



FOSSIL

INDIVIDUAL UNIT DRIVE FRIENDLY



4 x 8
3 7/8 x 7 7/8 x 2 3/8"
100 x 200 x 60mm

Color selection should be chosen from actual samples.

Fossil



TOP Dark Charcoal and Granite Blend (mixed on site)

BOTTOM Sable Blend

Color selection should be chosen from actual samples.

PRODUCT PAIRINGS



Pool & Wall Coping

BeaconHill™ Coping
See page 183

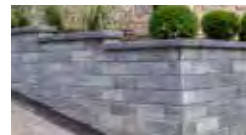

Walls

U-Cara® Smooth
See page 159



Steps

SienaStone™ Smooth
See page 185



Mattoni™

Exclusive to **UNILOCK**



ANTIQUED FINISH



GRANITE BLEND

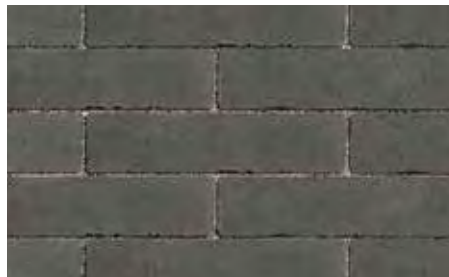

DARK CHARCOAL



SABLE BLEND

GRANITO BRUSHED FINISH



NOTTE



SCURO

See page 125 for
additional Granito.

INDIVIDUAL UNIT DRIVE FRIENDLY



2³/₈ x 9¹/₂ x 2³/₄"
60 x 240 x 70mm



PRODUCT PAIRINGS



Pool & Wall Coping

Umbriano®
See page 183



Walls

U-Cara® Umbriano
See page 159



Steps

Natural Stone
See page 187

TOP Summer Wheat

BOTTOM Winter Marvel

Color selection should be chosen from actual samples.



Umbriano®

Exclusive to **JNIOLOCK™**



SUMMER WHEAT

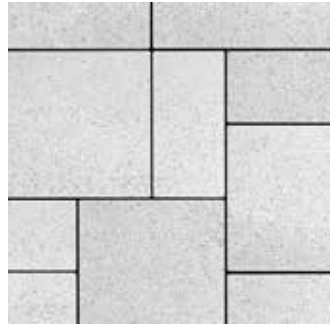

GRENADA WHITE



WINTER MARVEL



FRENCH GREY



MIDNIGHT SKY
7 x 14, 8 x 24" and 8 x 16" only

3 UNIT RANDOM BUNDLE AVAILABLE IN BOTH 60MM & 80MM
60mm not suitable for vehicular applications. 80mm can handle vehicular loads.

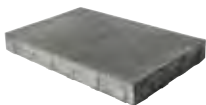

LARGE RECTANGLE
14¼ x 21½ x 2⅜ (3⅞)"
360 x 540 x 60 (80)mm

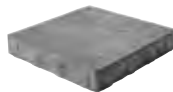

SQUARE
14¼ x 14¼ x 2⅜ (3⅞)"
360 x 360 x 60 (80)mm



SMALL RECTANGLE
7 x 14¼ x 2⅜ (3⅞)"
180 x 360 x 60 (80)mm

INDIVIDUAL UNITS DRIVE FRIENDLY



7 x 14 x 2⅜ (3⅞)"
180 x 360 x 60 (80)mm



8 x 16
7⅞ x 15 ¾ x 2¾"
200 x 400 x 70mm

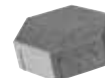

Hex
7⅞ x 7⅞ x 2¾"
200 x 200 x 70mm

See page 123 for additional finishes.



Color selection should be chosen from actual samples.

Summer Wheat



Umbriano® Slab

Exclusive to **UNILOCK**



SUMMER WHEAT



WINTER MARVEL



GRENADA WHITE



FRENCH GREY



MIDNIGHT SKY 8 x 24 and 18 x 36" only

PEDESTRIAN ONLY

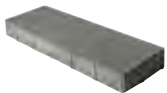

8 x 24
7⁷/₈ x 23⁵/₈ x 2³/₄"
200 x 600 x 70mm



12 x 24
11⁷/₈ x 23⁵/₈ x 2³/₄"
300 x 600 x 70mm

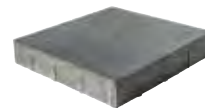

16 x 16
15³/₄ x 15³/₄ x 2³/₄"
400 x 400 x 70mm

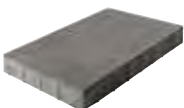

New 18 x 36
17³/₄ x 35¹/₂ x 2³/₈"
450 x 900 x 60mm



18 x 36
17³/₄ x 35¹/₂ x 3⁷/₈"
450 x 900 x 100mm

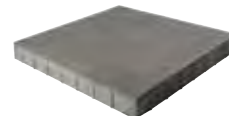

36 x 36
35¹/₂ x 35¹/₂ x 3⁷/₈"
900 x 900 x 100mm



PRODUCT PAIRINGS



Pool & Wall Coping

Beacon Hill™ Coping
See page 183

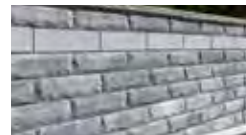

Walls

U-Cara™ Pitched
See page 159

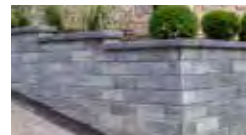

Walls

U-Cara Smooth
See page 159



Steps

SienaStone™ Smooth
See page 185

TOP Frost with Cophorne® (Basalt) accent

BOTTOM Metallic Grey

Color selection should be chosen from actual samples.

Revela™



Enhanced Surface

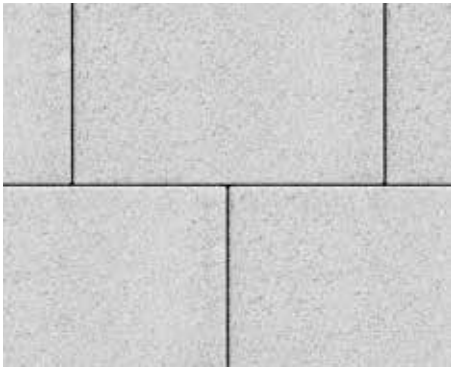

FROST



METALLIC GREY



SAVANNAH

3 UNIT RANDOM BUNDLE DRIVE FRIENDLY



LARGE RECTANGLE
14¼ x 21¼ x 3⅞"
360 x 540 x 80mm



SQUARE
14¼ x 14¼ x 3⅞"
360 x 360 x 80mm



SMALL RECTANGLE
7 x 14¼ x 3⅞"
180 x 360 x 80mm

SLAB PEDESTRIAN ONLY



21¼ x 35½ x 2⅜"
540 x 900 x 60mm

4 x 12 DRIVE FRIENDLY



3⅞ x 11⅞ x 4"
100 x 300 x 100mm

Metallic Grey Only



TOP Summer Wheat (Umbriano Finish)

BOTTOM Scuro (Granito Finish) with Beacon Hill™ Smooth (Opal Blend) pavers

Color selection should be chosen from actual samples.



Hex™

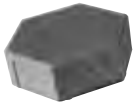

8 x 8
7¹/₈ x 7¹/₈ x 2³/₄"
200 x 200 x 70mm

UMBRIANO FINISH DRIVE FRIENDLY

ColorFusion™

See page 117-119 for additional shapes



SUMMER WHEAT



WINTER MARVEL



FRENCH GREY

GRANITO™ FINISH DRIVE FRIENDLY

Artista™

See page 125 for additional shapes



SABIA



NOTTE



SCURO



PRODUCT PAIRINGS



Pool & Wall Coping

Umbriano®
See page 183



Walls

U-Cara® Umbriano
See page 159



Steps

Natural Stone
See page 187

TOP Granito (Sabia Hex) with Copthorne® (Basalt) border and U-Cara® Smooth (Granite Mist) wall with LedgeStone™ (Buff) coping

BOTTOM Granito (Notte Hex)

Color selection should be chosen from actual samples.



Granito™

Exclusive to **UNILOCK**



NOTTE



SABIA



SCURO

3 UNIT RANDOM BUNDLE PEDESTRIAN ONLY ————— FLAGSTONE TEXTURE



LARGE RECTANGLE
14 x 21 x 2³/₈"
360 x 540 x 60mm



SQUARE
14 x 14 x 2³/₈"
360 x 360 x 60mm



SMALL RECTANGLE
7 x 14 x 2³/₈"
180 x 360 x 60mm



NOTTE



SABIA



SCURO

HEX UNIT DRIVE FRIENDLY ————— SMOOTH TEXTURE



8 x 8
7⁷/₈ x 7⁷/₈ x 2³/₄"
200 x 200 x 70mm

See page 123 for
additional finishes



ENDURACOLOR™

ARTISTA™
Boldly mottled color finish

 **EasyClean™**
Factory sealed for
integral stain resistance



Granito™ Mix



NOTTE BLEND

Exclusive to **UNILOCK**

3 FINISH MIXED BUNDLE DRIVE FRIENDLY

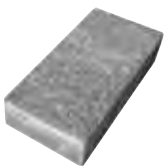

7 x 14 x 3/8"
180 x 360 x 80mm



7 x 14 x 3/8"
180 x 360 x 80mm

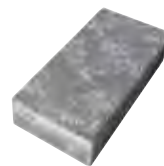

7 x 14 x 3/8"
180 x 360 x 80mm

Color selection should be chosen from actual samples.

Notte Blend



ENDURACOLOR™

EcoTerra 
 Reduced carbon emissions and refined surface protection



Promenade™ EcoTerra **New**



LIGHT STEEL GREY BLEND



LIGHT OPAL BLEND

INDIVIDUAL UNIT DRIVE FRIENDLY

Enhanced Surface



4 x 12
3⁷/₈ x 11⁷/₈ x 2³/₄"
100 x 300 x 70mm

Color selection should be chosen from actual samples.

Light Steel Grey Blend



PRODUCT PAIRINGS



Pool & Wall Coping

Beacon Hill™ Coping
See page 183



Walls

U-Cara® Pitched
See page 159

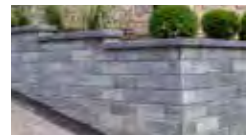

Walls

U-Cara Smooth
See page 159



Steps

SienaStone™ Smooth
See page 185

TOP Opal Blend, Steel Grey Blend, Granite Blend and Black Granite with Beacon Hill™ Slab (Opal Blend) banding

BOTTOM Opal Blend, Steel Grey Blend, Granite Blend and Black Granite

Color selection should be chosen from actual samples.

Promenade™



SMOOTH FINISH DRIVE FRIENDLY



OPAL BLEND



8 x 24
7⁷/₈ x 23⁵/₈ x 4"
200 x 600 x 100mm



STEEL GREY BLEND



4 x 16
3⁷/₈ x 15³/₄ x 4"
100 x 400 x 100mm

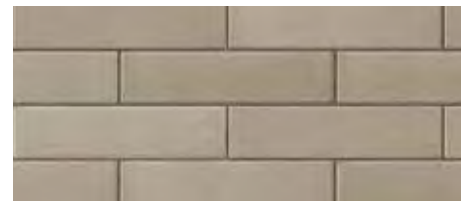

SANDSTONE 4x12 Only



4 x 12
3⁷/₈ x 11⁷/₈ x 4"
100 x 300 x 100mm

IL CAMPO FINISH DRIVE FRIENDLY

Brushed Finish



LIGHT GREY



8 x 24
7⁷/₈ x 23⁵/₈ x 4"
200 x 600 x 100mm

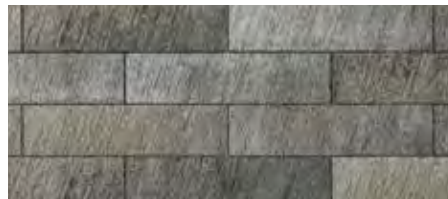

GRANITE BLEND



4 x 12
3⁷/₈ x 11⁷/₈ x 4"
100 x 300 x 100mm

See page 130 for additional shapes.



DARK CHARCOAL

SERIES FINISH DRIVE FRIENDLY

Exposed Granite



BLACK GRANITE



8 x 24
7⁷/₈ x 23⁵/₈ x 4"
200 x 600 x 100mm

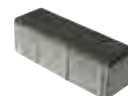

4 x 12
3⁷/₈ x 11⁷/₈ x 4"
100 x 300 x 100mm

See page 131 for additional shapes.



ENDURACOLOR™

Exclusive to **JUNILOCK**

Il Campo®



Brushed Finish



DARK CHARCOAL



GRANITE BLEND



LIGHT GREY



SANDSTONE

70MM & 80MM DRIVE FRIENDLY



4 x 8
 $3\frac{3}{8} \times 7\frac{7}{8} \times 2\frac{3}{4}$ "
 100 x 200 x 70mm
 Dark Charcoal only



7 x 14
 $7 \times 14\frac{1}{4} \times 3\frac{1}{8}$ "
 180 x 360 x 80mm
 Dark Charcoal only



8 x 16
 $7\frac{7}{8} \times 15\frac{3}{4} \times 2\frac{3}{4}$ "
 200 x 400 x 70mm
 All Colors

100MM DRIVE FRIENDLY

See page 129 for additional finishes.



8 x 24
 $7\frac{7}{8} \times 23\frac{5}{8} \times 4$ "
 200 x 600 x 100mm
 Not available in Sandstone



4 x 12
 $3\frac{3}{8} \times 11\frac{7}{8} \times 4$ "
 100 x 300 x 100mm
 Not available in Sandstone

Color selection should be chosen from actual samples.

Granite Blend



ENDURACOLOR™

Series™



Exposed Granite



BLACK GRANITE



MOUNTAIN MIST



GLACIER

70MM & 80MM DRIVE FRIENDLY



4 x 8
 $3\frac{7}{8} \times 7\frac{7}{8} \times 2\frac{3}{4}$ "
 100 x 200 x 70mm
 Black Granite only

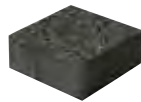

8 x 8
 $7\frac{7}{8} \times 7\frac{7}{8} \times 2\frac{3}{4}$ "
 200 x 200 x 70mm
 All Colors



8 x 16
 $7\frac{7}{8} \times 15\frac{3}{4} \times 2\frac{3}{4}$ "
 200 x 400 x 70mm
 All Colors

100MM DRIVE FRIENDLY



8 x 24
 $7\frac{7}{8} \times 23\frac{5}{8} \times 4$ "
 200 x 600 x 100mm
 Black Granite only



4 x 12
 $3\frac{7}{8} \times 11\frac{7}{8} \times 4$ "
 100 x 300 x 100mm
 Black Granite only

See page 129 for additional finishes.

Color selection should be chosen from actual samples.

Glacier, Mountain Mist and Black Granite (8 x 16")



ENDURACOLOR™

Eco-Priora™ Premier

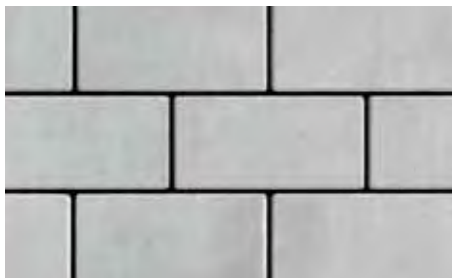

OPAL BLEND



STEEL GREY BLEND



RECTANGLE PERMEABLE DRIVE FRIENDLY



5 x 10
4¾ x 9½ x 3⅛"
120 x 240 x 80mm

Color selection should be chosen from actual samples.

Steel Grey Blend



ENDURACOLOR

Eco-Promenade®



OPAL BLEND

RECTANGLE PERMEABLE DRIVE FRIENDLY



3 x 12
3 x 11⁷/₈ x 4"
75 x 300 x 100mm

Color selection should be chosen from actual samples.

Opal Blend with Custom accent



ENDURACOLOR™

Tribeca Cobble™



CRYSTALLINE BASALT



PEPPERED GRANITE



3 UNIT RANDOM BUNDLE PERMEABLE DRIVE FRIENDLY

Exposed Granite



LARGE RECTANGLE
5 x 12 x 2 3/4"
130 x 305 x 70mm



MEDIUM RECTANGLE
5 x 9 x 2 3/4"
130 x 230 x 70mm



SMALL RECTANGLE
5 x 6 7/8 x 2 3/4"
130 x 175 x 70mm

Color selection should be chosen from actual samples.

Crystalline Basalt with Peppered Granite accent



ENDURACOLOR™

Nordic Cobble™



OPAL BLEND **NEW**



GRANITE MIST **NEW**



DARK CHARCOAL **NEW**

INDIVIDUAL UNIT PERMEABLE DRIVE FRIENDLY

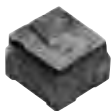

TRAPEZOID
3⁵/₈ x 3³/₄ x 2³/₈"
89.9 x 94 x 60mm

Color selection should be chosen from actual samples.

Opal Blend and Granite Mist mix with Courtstone® accent

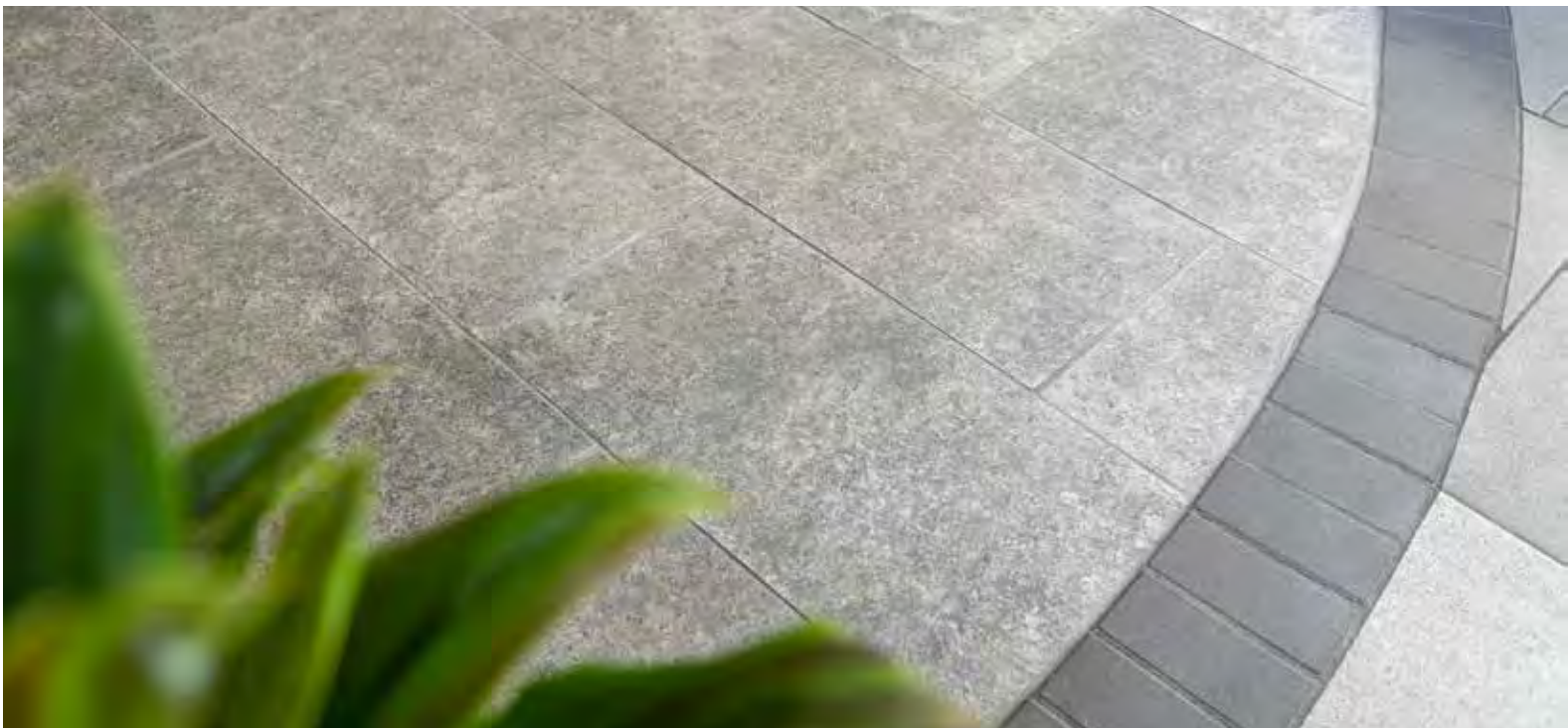

TOP Graustein

BOTTOM Unilock Grey Travertine

Color selection should be chosen from actual samples.

Porcelain Tile

Suitable for wood deck and concrete overlays.



24 x 24 PEDESTRIAN ONLY



GOTHAM GREY
DELCONCA USA



TRAVSTONE BEIGE
DELCONCA USA



GRAUSTEIN
CAESAR



24 x 24
23⁵/₈ x 23⁵/₈ x ³/₄"
600 x 600 x 20mm

16 x 32 PEDESTRIAN ONLY



UNILOCK
COSMIC GREY



UNILOCK
DOVE GREY TRAVERTINE



TRAVSTONE BEIGE
DELCONCA USA



16 x 32
15³/₄ x 31¹/₂ x ³/₄"
400 x 800 x 20mm

Please contact your contractor or a local Unilock Authorized Dealer for more information and availability.



- TOP** Indian Coast
- LEFT** Stone Cliff Grey
- RIGHT** Castle Grey

Color selection should be chosen from actual samples.

Natural Stone

Suitable for pool decks, wood decks, patios, entrances and concrete overlays.



SANDSTONE & LIMESTONE PEDESTRIAN ONLY

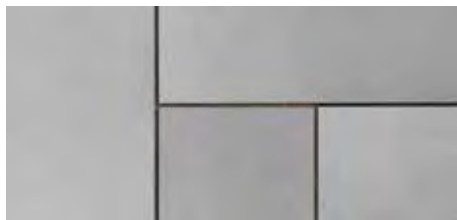

GREYFIELD SANDSTONE



INDIAN COAST SANDSTONE

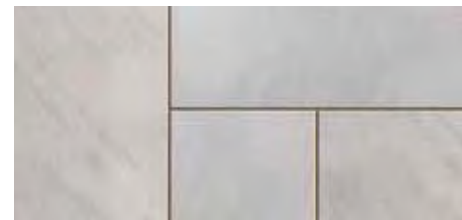

IVORY SAND SANDSTONE



STONE CLIFF GREY SANDSTONE



BLACK RIVER LIMESTONE

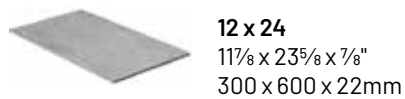

GRANITE PEDESTRIAN ONLY



BLACK OYSTER

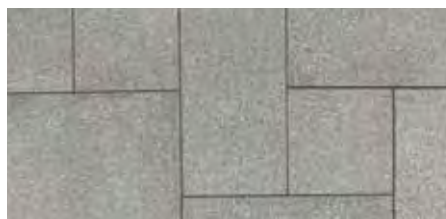

CASTLE GREY



GALAXY FROST

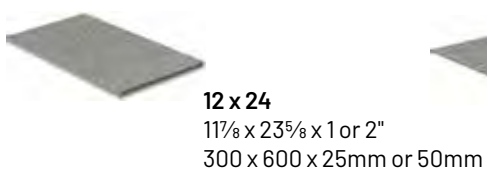

Please contact your contractor or a local Unilock Authorized Dealer for more information and availability.

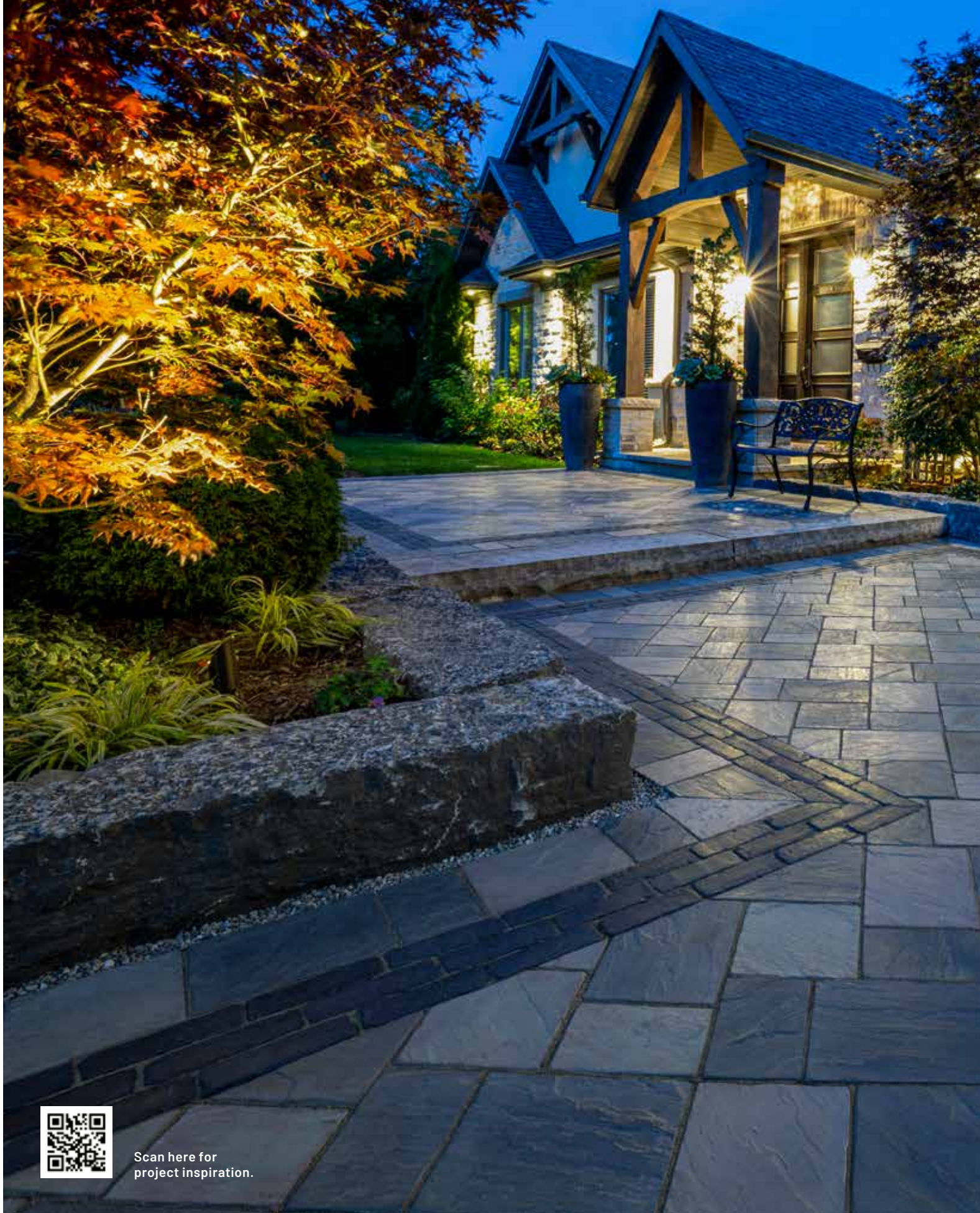

Scan here for
project inspiration.

Richcliff®

EXCLUSIVE TO **JNIOCK**

Inspired by the texture of natural cut flagstone, Richcliff offers superior durability and timeless appeal ideal for driveways, patios, walkways and commercial projects.

A multitude of stone textures were cast using Reala™ Technology, to ensure that finished projects will have a completely random and natural appearance. And unlike natural stone, which can crack, split and fade, Richcliff is virtually indestructible.

 **ELEGANCE™**



Dawn Mist and Pebble Taupe Mix

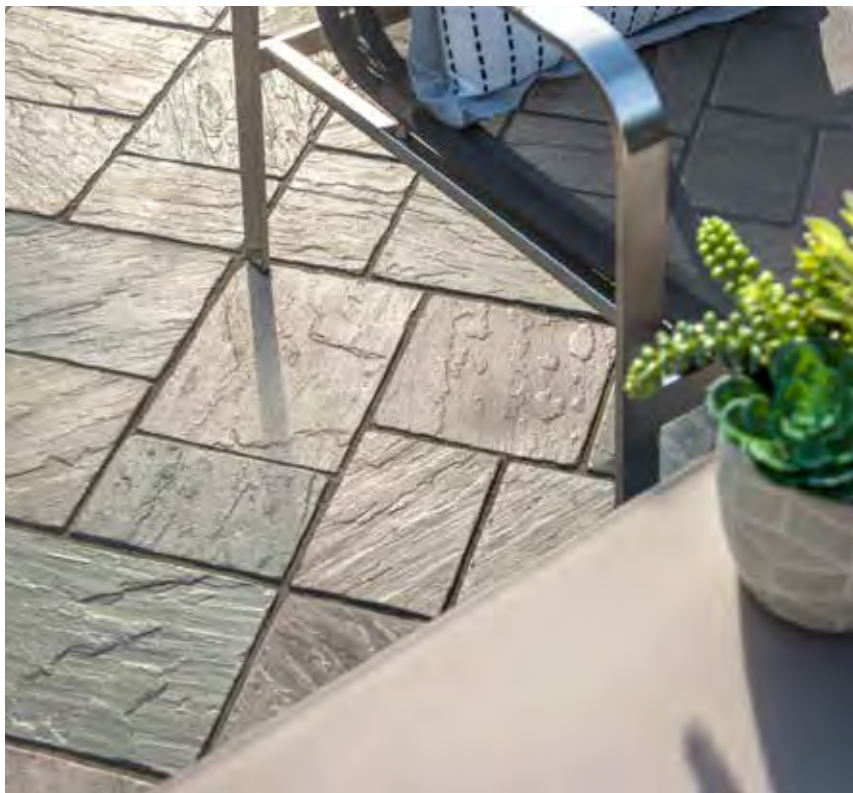

PRODUCT PAIRINGS



Pool & Wall Coping

Umbriano
See page 183



Walls

U-Cara® Smooth
See page 159



Walls

U-Cara Umbriano®
See page 159



Steps

Natural Stone
See page 187

TOP Dawn Mist and Pebble Taupe (mixed on site)

BOTTOM Dawn Mist and Pebble Taupe (mixed on site)

Color selection should be chosen from actual samples.



Richcliff®

Exclusive to **UNILOCK**



SMOKE SHALE



DAWN MIST



PEBBLE TAUPE



PEBBLE TAUPE / DAWN MIST
Blended on Site

3 UNIT RANDOM BUNDLE DRIVE FRIENDLY



RECTANGLE
8⁷/₈ x 11⁷/₈ x 2³/₈"
226 x 300 x 60mm



SQUARE
8⁷/₈ x 8⁷/₈ x 2³/₈"
226 x 226 x 60mm



SMALL RECTANGLE
5⁷/₈ x 8⁷/₈ x 2³/₈"
150 x 226 x 60mm

LARGE RECTANGLE PEDESTRIAN ONLY



11⁷/₈ x 20⁷/₈ x 2³/₈"
302 x 528 x 60mm



Scan here for
project inspiration.

Courtstone®

EXCLUSIVE TO **JNIOCK**

The polished look of Courtstone brings a luxurious, old-world elegance, with Ultima™ Concrete Technology providing up to four times the strength of conventional poured concrete.

The unique shapes of Courtstone are cast from real European cobblestones using Reala™ Technology, but manufactured with a consistent base for efficient installation and superior interlock.

 **ELEGANCE**





PRODUCT PAIRINGS



Pool & Wall Coping

Umbriano®
See page 183



Walls

U-Cara® Smooth
See page 159



Walls

U-Cara Umbriano
See page 159



Steps

Natural Stone
See page 187

TOP Basalt

BOTTOM Basalt with Umbriano®(Summer Wheat)

Color selection should be chosen from actual samples.



ULTIMA™

Up to 4x stronger than poured-in-place concrete

REALA™

Cast from European cobblestones



COURTSTONE

Courtstone®

Exclusive to **UNILOCK**



BASALT

5 UNIT RANDOM BUNDLE DRIVE FRIENDLY



XL Rectangle
5 1/8 x 8 3/8 x 2 3/8"
130 x 215 x 60mm



LARGE RECTANGLE
5 1/8 x 7 1/4 x 2 3/8"
130 x 185 x 60mm



RECTANGLE
5 1/8 x 6 1/2 x 2 3/8"
130 x 165 x 60mm



SMALL RECTANGLE
5 1/8 x 5 3/4 x 2 3/8"
130 x 145 x 60mm



SQUARE
5 1/8 x 5 1/8 x 2 3/8"
130 x 130 x 60mm



Scan here for
project inspiration.

Town Hall[®]

EXCLUSIVE TO **JNIOLOCK**

Modeled after historic North American clay street pavers, Town Hall is perfect for any traditional or permeable applications. The rich colors and classic shape also make it a popular border or accent paver.

Town Hall textures were cast from a multitude of different surfaces using Reala™ Technology, for a vintage, streetscape charm that stands the test of time.

 **ELEGANCE**





PRODUCT PAIRINGS



Pool & Wall Coping

Umbriano®
See page 183



Walls

U-Cara® Smooth
See page 159



Walls

U-Cara Umbriano
See page 159



Steps

Natural Stone
See page 187

TOP Basalt

BOTTOM 3 Color Blend

Color selection should be chosen from actual samples.



ULTIMA™
Up to 4x stronger than
poured-in-place concrete

REALA™
Cast from
historical brick

EasyClean™
Factory sealed for
integral stain resistance



Town Hall®

Exclusive to **UNILOCK**



BURGUNDY RED



BURNT CLAY



OLD OAK



3 COLOR BLEND Blended on Site



BASALT

INDIVIDUAL UNIT PERMEABLE DRIVE FRIENDLY



3 7/8 x 9 7/8 x 2 3/4"
100 x 250 x 70mm



Scan here for
project inspiration.

Copthorne®

EXCLUSIVE TO **JNIOLOCK**

Inspired by the rich color and timeworn beauty of European street pavers, Copthorne offers more delicate dimensions than Town Hall®. These proportions make it possible to design curved walkways and borders without the need for cutting.

Cast using Reala™ Technology for an authentic surface appearance, and Ultima™ Concrete Technology to deliver up to four times the strength of conventional poured concrete, Copthorne offers timeless beauty.

 **ELEGANCE™**





PRODUCT PAIRINGS



Pool & Wall Coping

Umbriano®
See page 183



Walls

U-Cara® Smooth
See page 159



Walls

U-Cara Umbriano
See page 159



Steps

Natural Stone
See page 187

TOP 3 Color Grey Blend

BOTTOM 3 Color Blend with Basalt accent and Beacon Hill™ Smooth (Granite Mist)

Color selection should be chosen from actual samples.



Copthorne®

Exclusive to **UNILOCK**



BURGUNDY RED



BURNT CLAY



OLD OAK



3 COLOR BLEND
Blended on Site



ARCTIC GREY **NEW**



STEEL BLUE



BASALT



3 COLOR GREY BLEND
Blended on Site

INDIVIDUAL UNIT DRIVE FRIENDLY



2⁵/₈ x 7⁷/₈ x 2³/₈"
65 x 200 x 60mm





Retaining Walls & Vertical Features

Unlimited creative possibilities exist for retaining soil or building vertical features like grill islands and firepits.

Pavers: Treo® Smooth (Granite Mist) and Granito™ (Sabia) Hex with Copthorne® (Basalt) accent
Wall: U-Cara® Wall Mount System with U-Cara Smooth Fascia Panels (Granite Mist)



NEW PANELS COMING SOON

COMING SOON SUBWAY PANEL



INDIANA BUFF



OPAL BLEND



CHARCOAL

COMING SOON LAVANO PANEL

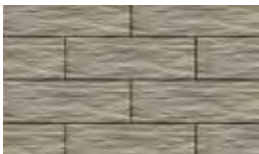

FOSSIL

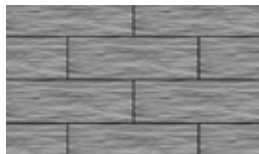

GRANITE MIST

COMING SOON NEOLINE PANEL



INDIANA BUFF



STERLING





reddot

2019

U-Cara received the "red dot" award for high design quality and innovation.

U-Cara® Multi-Face Wall System

This patented wall system, exclusive to Unilock, represents a revolution in wall design. With U-Cara it's now possible to design walls, pillars, planters, fire features, grill islands and more.

FASCIA PANELS



SMOOTH PANEL

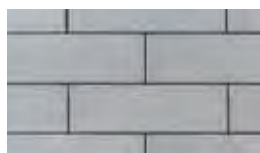

OPAL BLEND



GRANITE MIST

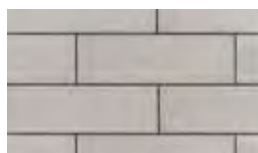

LINEN GREY **NEW**

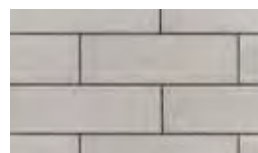

STERLING

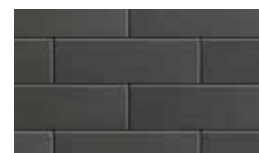

DARK CHARCOAL



LINEN BUFF **NEW**

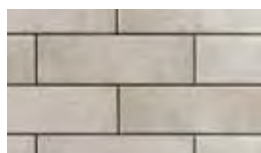

INDIANA BUFF

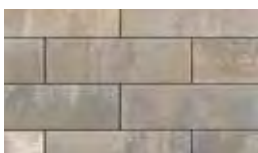

ALMOND GROVE



FOSSIL

UMBRIANO PANEL

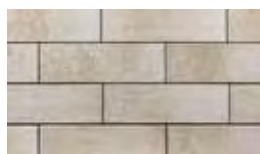

SUMMER WHEAT



GRENADA WHITE



WINTER MARVEL



FRENCH GREY

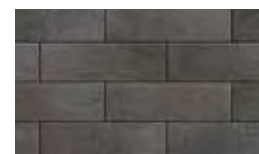

MIDNIGHT SKY

PITCHED PANEL



ALMOND GROVE



GRANITE MIST

SERIES 3" PANEL



BLACK GRANITE



TOP Winter Marvel Umbriano with Umbriano (French Grey) pavers and Umbriano coping

LEFT Opal Blend Smooth with Granite Mist Pitched accent

RIGHT Dark Charcoal Smooth

Color selection should be chosen from actual samples.

U-Cara® Multi-Face Wall System



1 BASE UNIT



2 BACKER BLOCKS

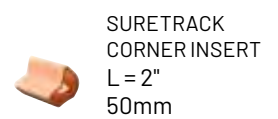
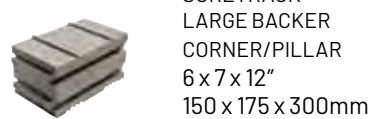
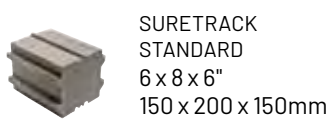

3 FASCIA PANELS

6" STANDARD FASCIA

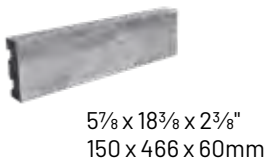

3" SERIES PANEL



2 UNIT CORNER BUNDLE

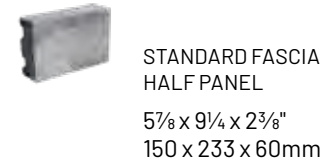

4 FASCIA PANEL STYLES



SMOOTH



PITCHED

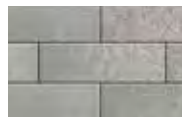

UMBRIANO



SERIES



SUBWAY



LAVANO



NEOLINE

5 COPING

BEACON HILL™ COPING



SEE PAGE 183

UMBRIANO COPING



SEE PAGE 183

UNIVERSAL COPING



SEE PAGE 184

URBAN/URBAN ALLURE COPING



SEE PAGE 182

U-Cara® Modular System

Our U-Cara Modular System offers a variety of aluminium frames that can be mixed and matched to construct vertical features like grill islands, fire features and pillars.

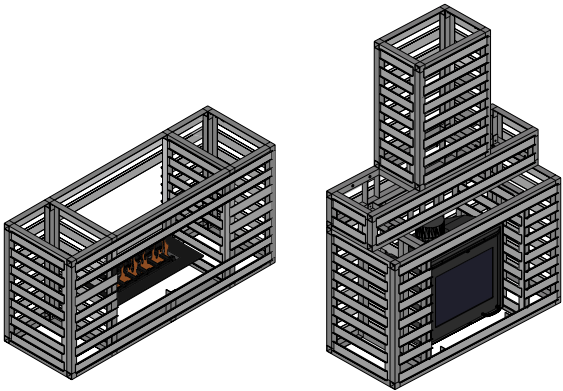
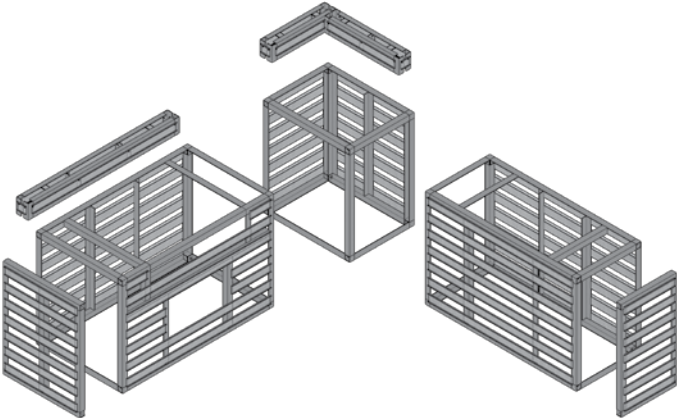

Speak to your contractor to select a design and a U-Cara fascia panel finish to suit your project.

U-Cara® Wall Mount System

The U-Cara Wall Mount System allows you to put the finishing touches on your project by cladding existing structures with U-Cara fascia panels.



Ideal for garden sheds, wing walls, exposed foundation, existing steps or concrete and wood substrates.



PRODUCT PAIRINGS



Paver
Metro™ Smooth
See page 103



Pool & Wall Coping
Universal
See page 184

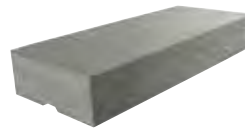

Steps
SienaStone™ Smooth
See page 185

TOP Granite Blend with Mattoni™ (Dark Charcoal) accent and Beacon Hill™ Smooth (Granite Mist)

BOTTOM Granite Blend and Charcoal accent with Artline™ (Fossil) pavers and Natural Stone (Black river) coping

Color selection should be chosen from actual samples.

CLASSIC

Lineo™ Dimensional Stone



SAFARI

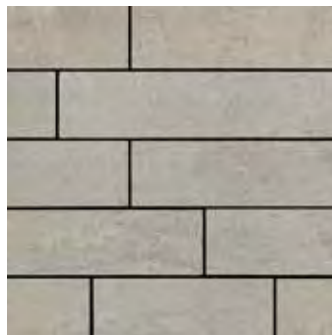

DUSK



GRANITE BLEND



CHARCOAL

4 UNIT RANDOM BUNDLE

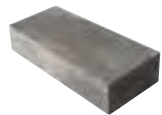

4 x 24 x 8"
100 x 600 x 200mm

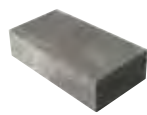

4 x 20 x 8"
100 x 500 x 200mm

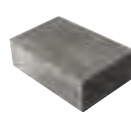

4 x 16 x 8"
100 x 400 x 200mm

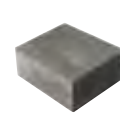

4 x 12 x 8"
100 x 300 x 200mm

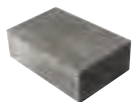

PILLAR / CORNER
4 x 16 x 8"
100 x 400 x 200mm

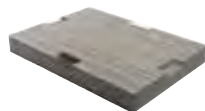

U-GRIP™ BASE PAD
14 x 19 x 2"
355 x 482 x 55mm



PRODUCT PAIRINGS

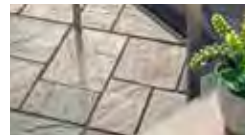

Paver
Richcliff®
Page 141



Pool & Wall Coping
Ledgestone™
See page 186



Steps
Rivercrest with
Ledgestone coping
Page 186

TOP Coastal Slate with Copthorne® (Basalt) accent and Umbriano® (Winter Marvel) pavers

BOTTOM Coastal Slate with Natural Stone (Black River) coping

Color selection should be chosen from actual samples.



2013

Rivercrest received the "red dot" award for high design quality and innovation.

Rivercrest® Wall



COASTAL SLATE



BUFF

4 UNIT RANDOM BUNDLE



STANDARD UNIT 1
8 x 9-10 x 2¼"
200 x 230-250 x 57mm



STANDARD UNIT 2
12 x 9-10 x 2¼"
300 x 230-250 x 57mm



STANDARD UNIT 3
12 x 9-10 x 2¼"
300 x 230-250 x 57mm



STANDARD UNIT 4
17 x 9-10 x 2¼"
425 x 230-250 x 57mm

2 UNIT CORNER BUNDLE



LONG CORNER UNIT
17½ x 9-10 x 2¼"
450 x 230-250 x 57mm



SHORT CORNER UNIT
14½ x 9-10 x 2¼"
375 x 230-250 x 57mm



PRODUCT PAIRINGS



Paver

Windermere™ Smooth
See page 101



Pool & Wall Coping

Pisa™ Smooth
See page 169



Steps

SienaStone™ Smooth
See page 185

TOP Granite Blend with Universal Coping (Light Grey) and Natural Stone (Black River) pillar cap

BOTTOM Granite Blend with Universal Coping (Charcoal)

Color selection should be chosen from actual samples.

CLASSIC

Pisa Smooth™



CHARCOAL **NEW**



DUSK **NEW**



SAFARI **NEW**

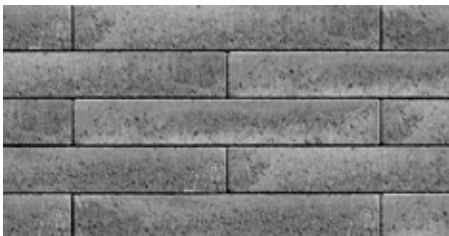

GRANITE BLEND



CLIFFSIDE GREY



STANDARD/CORNER

10⁷/₈ x 21³/₄ x 3³/₈"
275 x 550 x 85mm

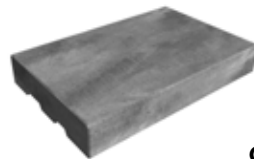

COPING

13⁷/₈ x 21³/₄ x 3³/₈"
350 x 550 x 85mm

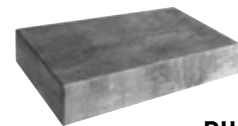

PILLAR

10⁷/₈ x 21³/₄ x 3³/₈"
275 x 550 x 85mm



U-GRIP™ BASE PAD

14 x 19 x 2"
355 x 482 x 55mm



**JUMPER STANDARD/
CORNER**

10⁷/₈ x 21³/₄ x 6²/₃"
275 x 550 x 170mm

CLASSIC

Brussels Dimensional Stone®



PRODUCT PAIRINGS



Paver

Brussels Block®
See page 64

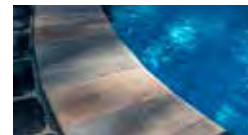

Pool & Wall Coping

Brussels Fullnose™
See page 64



Pool & Wall Coping

Universal
See page 184



Steps

SienaStone™ Smooth
See page 185



SANDSTONE



COFFEE CREEK



MAHOGANY



LIMESTONE



CHARCOAL



STANDARD

12 x 4 x 8"
300 x 100 x 200mm



U-GRIP™ BASE PAD

14 x 19 x 2"
355 x 482 x 55mm



SUNSET FIREPIT KITS

Available in Coffee Creek, Mahogany and Sandstone



Round



Square

CLASSIC

Pisa™



PRODUCT PAIRINGS



Paver
Hollandstone™
See page 112



Pool & Wall Coping
Pisa™
See page 169



Steps
SienaStone™
See page 185



NATURAL



GRANITE



MAHOGANY



SIERRA



STANDARD
8 x 12 x 6"
200 x 300 x 150mm



TAPERED
8 x 12 x 6"
200 x 300 x 150mm



CORNER
8 x 12 x 6"
200 x 300 x 150mm



24" COPING
12 x 24 x 3"
300 x 600 x 75mm



U-GRIP™ BASE PAD
14 x 19 x 2"
355 x 482 x 55mm



CLASSIC

SienaStone™



NATURAL



CORNER 45°
(LEFT & RIGHT)
20 x 43¹/₃ x 7¹/₄"
500 x 1100 x 185mm



CORNER 90°
(LEFT & RIGHT)
20 x 43¹/₃ x 7¹/₄"
500 x 1100 x 185mm



STANDARD 925
37¹/₂ x 47¹/₄ x 7¹/₄"
925 x 1200 x 185mm

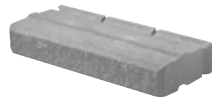

STANDARD 500
20 x 47¹/₄ x 7¹/₄"
500 x 1200 x 185mm



STANDARD 333
13 x 47¹/₄ x 7¹/₄"
333 x 1200 x 185mm



COPING
20 x 47¹/₄ x 7¹/₄"
500 x 1200 x 185mm

Color selection should be chosen from actual samples.



CLASSIC

SienaStone™ Smooth



GRANITE BLEND



SAFARI



STANDARD 375
14¾ x 47¼ x 7"
375 x 1200 x 180mm



CORNER 375
14¾ x 38¾ x 7"
375 x 975 x 180mm



COPING 383
15 x 47¼ x 7"
383 x 1200 x 180mm



**CLOSED-END
COPING 383**
15 x 47¼ x 7"
383 x 1200 x 180mm

Color selection should be chosen from actual samples.

Granite Blend

Firepits and Fire Features

Imagine flames crackling on a cool night, curling up under the stars with friends and family, and sipping a warm cup of hot chocolate. Soak up that sense of bliss from your backyard with a Unilock firepit!

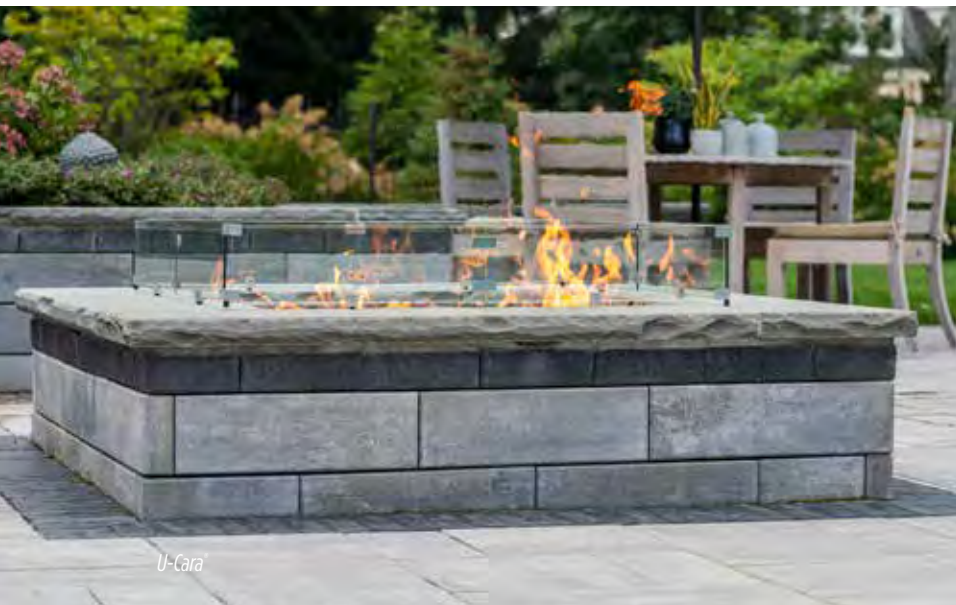



U-Cara

HEAT DAMAGE PREVENTION

To ensure a long-lasting fire feature, direct exposure to extreme heat from an open flame should be avoided. Always construct fire features with a protective heat barrier such as a metal insert, refractory blocks or approved firebrick to prevent potential heat damage.

NOTE: Large fires and extreme heat are detrimental to concrete.

SUNSET FIREPIT KIT



Square shape also available.

UNILOCK REDUCED SMOKE INSERT

ZENTRO TECHNOLOGY FIREPIT INSERT AVAILABLE FOR ALL FIREPIT KITS.

There's nothing like relaxing around a roaring fire to bring family and friends closer together. But with ordinary firepits, smoke always blows in someone's face - usually yours. With Unilock Reduced Smoke Inserts, stinging eyes are a thing of the past. Zentro's patent-pending technology reburns smoke before it gets anywhere near your eyes. Say hello to good times and goodbye to smoke.

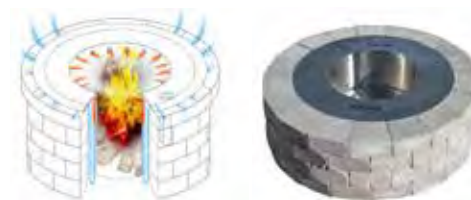

FIREPIT INSERT

Firepit kit comes with a firepit insert (sold separately) that fits securely into the firepit.

Outdoor Kitchens

There's nothing more fun than cooking al fresco. An outdoor kitchen is an entire, defined space dedicated to preparing meals among family and friends, but with a much livelier backdrop!



Learn about things to consider when designing your outdoor kitchen.





U-Cara

Design Considerations

Think about how you'll use the space, the outdoor appliances you need, the best location for a kitchen in your yard, and how it will weather in the elements over time.



Rivercrest™ Wall



Lineo Dimensional Stone

From a practical side, an outdoor kitchen is an extension of your home's living and entertaining space, allowing you to make the most of your backyard.

Water Features & Pillars

From fountains and ponds, to waterfalls and custom water features, these soothing additions are a popular way to enhance your landscape design.

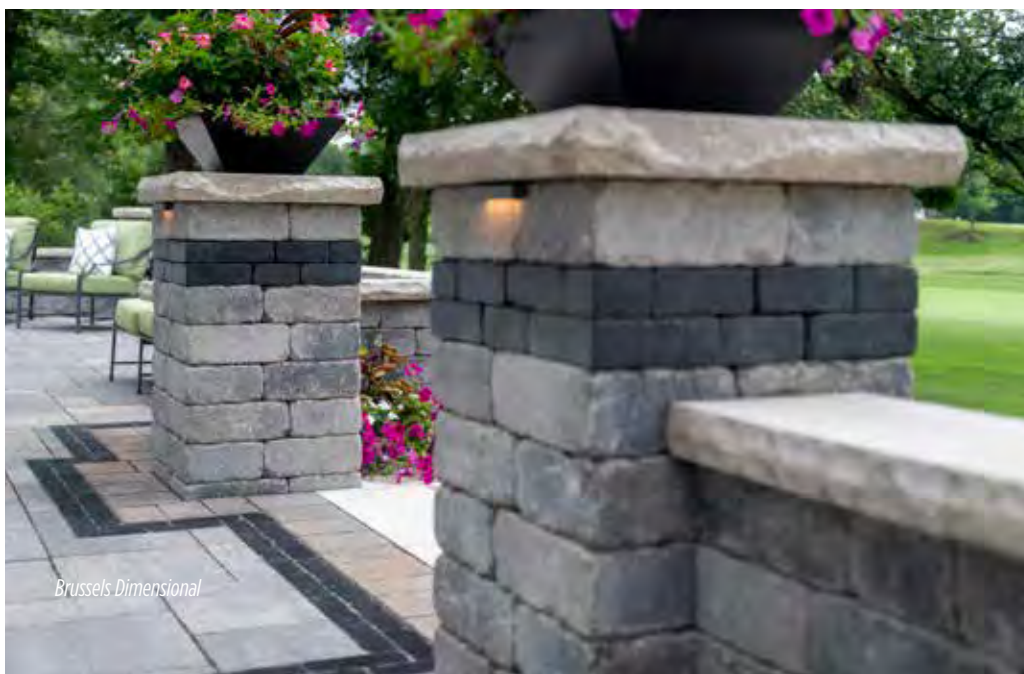
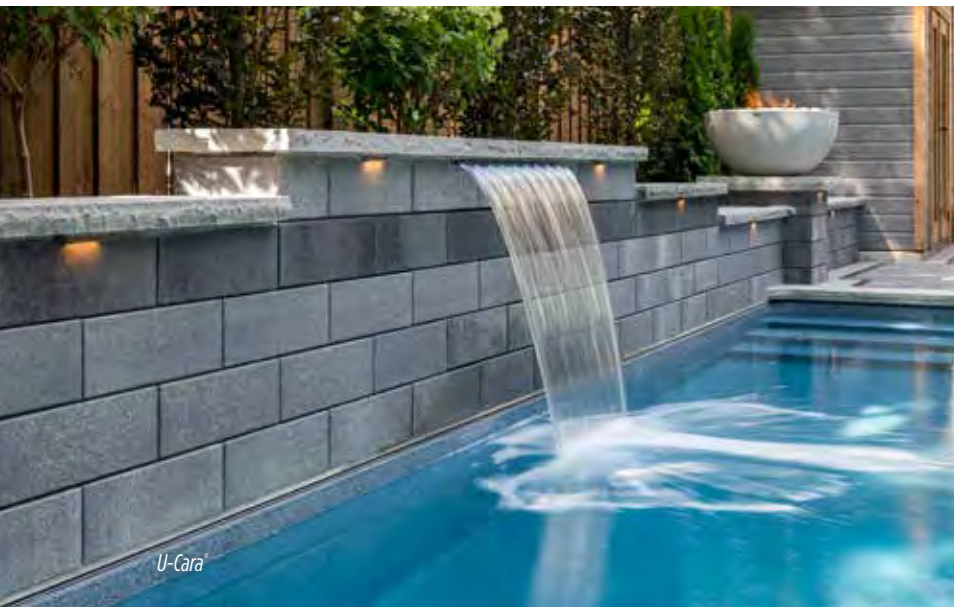

Elevate your outdoor space to new heights by incorporating pillars into your design. With varying heights and functions, pillars create a sense of permanence and strength while also adding visual flair. Take it a step further by incorporating landscape lighting into your pillars to set the mood at night.

Creative Ideas

The versatility of Unilock products provides a playground for your imagination. From mixing patterns and colors to create a custom sports court, to utilizing Unilock wall systems to beautify a utilitarian window well, the possibilities are endless!



This small storage area becomes a thing of beauty, paved with Unilock Beacon Hill™ Smooth and Universal Coping treads.

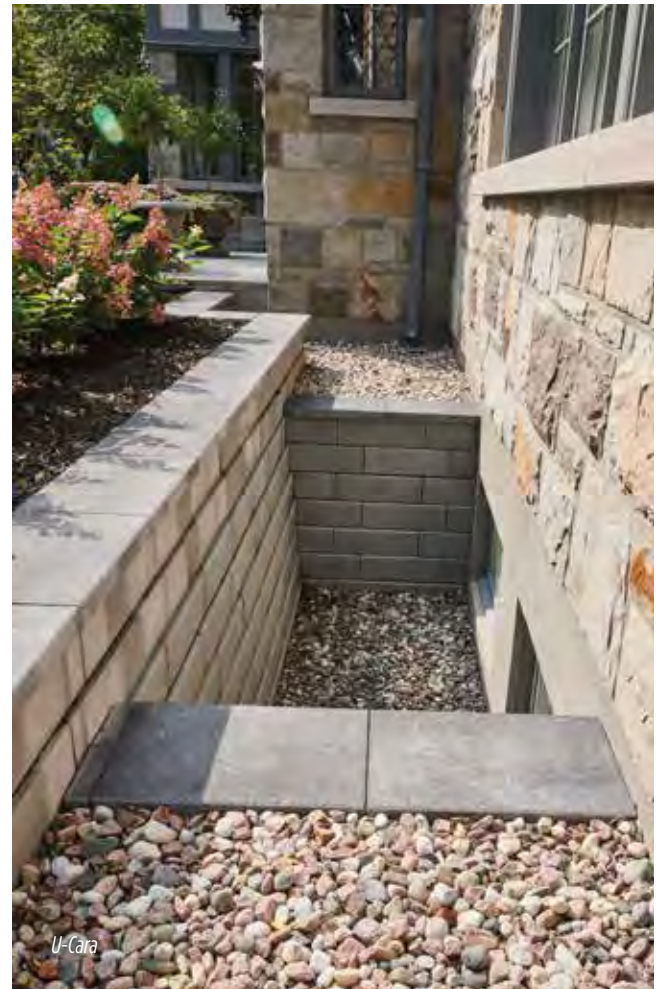





Steps, Treads, Coping & Caps

From classic, fullnose shapes to pitched-face edges, our steps, treads and coping offer a wide variety of choices for the finishing touch on your project.

Urban™ Coping

ENDURACOLOR™



INDIANA BUFF



STERLING



DARK CHARCOAL **NEW**

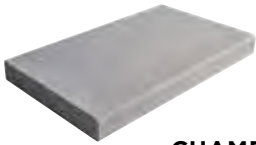

CHAMFERED
19 x 35½ x 2⅜"
485 x 900 x 60mm

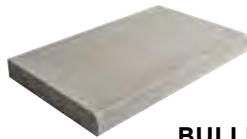

BULLNOSE
19 x 35½ x 2⅜"
485 x 900 x 60mm

Urban Allure Coping **New**

 **comfort step.**
Ultra-smooth surface texture

ENDURACOLOR™



LINEN BUFF



LINEN GREY

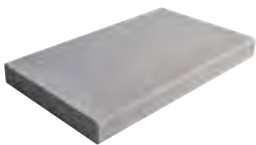

CHAMFERED
19 x 35½ x 2⅜"
485 x 900 x 60mm



BULLNOSE
19 x 35½ x 2⅜"
485 x 900 x 60mm

Umbriano® Coping

ENDURACOLOR™

Exclusive to **JNIBLOCK**



SUMMER WHEAT



GRENADA WHITE



WINTER MARVEL

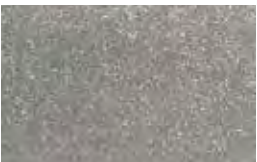

FRENCH GREY



MIDNIGHT SKY



BULLNOSE
14 x 24 x 2³/₈"
360 x 600 x 60mm



CHAMFERED
14 x 24 x 2³/₈"
360 x 600 x 60mm

Beacon Hill™ Coping

ENDURACOLOR™



ALMOND GROVE



GRANITE MIST

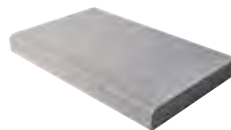

BULLNOSE
14 x 24 x 2³/₈"
360 x 600 x 60mm



FOSSIL



OPAL BLEND



CHAMFERED
14 x 24 x 2³/₈"
360 x 600 x 60mm



Universal Coping

ENDURACOLOR™



LIGHT GREY



DARK CHARCOAL

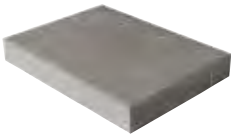

COPING/STEP
14 x 19 x 2³/₄"
355 x 482 x 70mm

Pisa™ Smooth Coping



CLIFFSIDE GREY



GRANITE BLEND

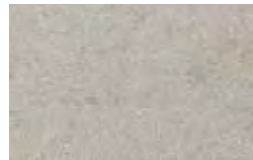

DUSK **NEW**



SAFARI **NEW**



CHARCOAL **NEW**

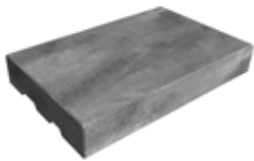

COPING
13⁷/₈ x 21³/₄ x 3³/₈"
350 x 550 x 85mm

Pisa Coping



GRANITE



MAHOGANY



NATURAL



SIERRA



24" COPING
11⁷/₈ x 23⁵/₈ x 3"
300 x 600 x 75mm

SienaStone™ Smooth Step



GRANITE BLEND



DUSK



SAFARI



CLIFFSIDE GREY

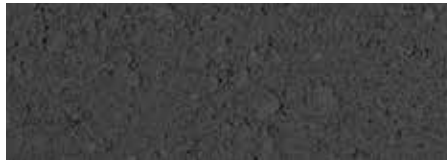

CHARCOAL



48" STEP
20 x 47 $\frac{1}{4}$ x 7"
500 x 1200 x 180mm



72" STEP
20 x 70 $\frac{3}{4}$ x 7"
500 x 1800 x 180mm

Not available in Cliffside Grey

NOTE: 2 Edge details available on the same unit (Chamfer and Rounded)
Contact a Unilock representative for more information.

SienaStone Step



GRANITE



MAHOGANY



NATURAL



48" STEP
19 $\frac{3}{4}$ x 47 $\frac{1}{4}$ x 7 $\frac{3}{8}$ "
500 x 1200 x 185mm

Ledgestone™

Coping & Step

STONEMARK™

SPECIAL ORDER PRODUCT



BUFF



GREY



COPING

12 x 24 x 2³/₄"
305 x 610 x 70mm



CLOSED END COPING

12 x 24 x 2³/₄"
305 x 610 x 70mm



FULLNOSE COPING

12 x 24 x 2³/₈"
305 x 610 x 60mm



48" STEP

24 x 48 x 6"
610 x 1220 x 150mm

While quantities last



REALA™

Cast from natural stone

Natural Stone

Coping & Steps

AVAILABLE IN BOTH ROCK FACE AND SMOOTH

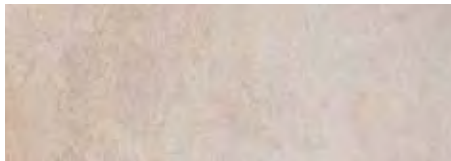

INDIAN COAST SANDSTONE



IVORY SAND SANDSTONE

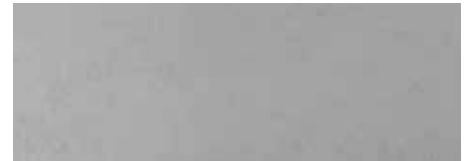

GREYFIELD SANDSTONE

AVAILABLE IN ROCK FACE ONLY



STONE CLIFF GREY SANDSTONE



BLACK RIVER LIMESTONE



48" LENGTH
14 x 48 x 2"
360 x 1200 x 50mm



72" LENGTH
14 x 72 x 2"
1830 x 360 x 50mm



48" LENGTH
16 x 47 1/4 x 6"
400 x 1200 x 150mm



72" LENGTH
16 x 70 3/4 x 6"
400 x 1800 x 150mm





Learn & Plan

Nothing ventured, nothing gained! Transform your hardscape ideas into bold, thrilling reality with the right help, knowledge and preparation. Unilock has the experts, the plans and the tools you need to succeed!





Come visit us in Georgetown Ontario

UNILOCK Outdoor Idea Center

See

An expansive display of Unilock products in a life-size outdoor setting

Talk

To our knowledgeable staff and we'll help you create a plan to achieve the outdoor space you're dreaming about.

Take

FREE samples of Unilock paver and wall products home with you.



287 Armstrong Ave, Georgetown, ON

Scan here for more information and a 3D virtual tour!



Please feel free to walk around and browse our Outdoor Idea Center at any time. Call 1-800-UNILOCK or visit Unilock.com for more details and staff hours.



UVISION®
— 3D LANDSCAPE CREATOR —



3D Rendering Created with Uvision® 3D Design Software



Finished Project

While there are many contractors and designers who still prefer to draw by hand, more and more plans today are being created digitally and in 3D.

If you're having trouble imagining what your project will look like when it's complete, a 3D design can really help.

Speak to your contractor about how 3D design can help you visualize the possibilities for your project!

Connect with us online or by phone to find a qualified contractor who can prepare a 3D design for your project!

Your one-stop shop for a wide variety of resources to help you kick-start your hardscape project, the Unilock way!

Resources at **Unilock.com**

Throughout your project journey we know you'll have lots of questions, and our website has answers. From the hundreds of topics covered in our Knowledge Center, to design advice and inspiration, we're here to help far beyond your selection of Unilock products. We can even help you connect with a local installation contractor you can trust. Connect with us online or at 1-800-UNILOCK.



Knowledge Center



Design Advice



Unilock Authorized Contractors



Frequently Asked Questions



Protect your Investment

Learn how to take care of your Unilock products to ensure that they stay beautiful and functional for years to come.



Spring

While the majority of Unilock products require little maintenance, there are a number of preventative steps that can be performed each spring to ensure that your project keeps its pristine appearance throughout patio season.

Examine for “creep” – this is where pavers push out as a result of winter stress, traffic or edge restraint failure – as well as dips, deformations or stains. Should you discover any of these problems, they are fixable; speak to your contractor or reach out to us for solutions. Wash your paver surface with a simple soap and water solution and top up jointing material if necessary.

Fall

While the leaves changing colors in the fall is a beautiful sight, the stains they leave behind on pavers can be an eyesore. Clean any debris, and remove any planters, barbecues or furniture that may leave behind rust marks.

Winter

Metal blades on plows or shovels may scratch the surface of your pavers. It is recommended you use plastic shovels or protective plastic blades on your plows or snow blowers. Although Unilock products are resistant to de-icing salt, it is strongly advised to use calcium-based products or rock salt (sodium chloride) to melt ice.

Note: Avoid magnesium-based de-icing products as they are very aggressive and may cause damage to the surface of pavers.

STOP WEEDS BEFORE THEY TAKE ROOT

Weeds do not grow up from the soil below. Instead, dirt and weed seeds blow in from adjacent lawn and garden areas and may germinate in between the joints. Keeping the joint sand topped up near the surface will help the weed seeds to blow over the joint and not into the joint.

IN THE PAST - Basic sand was the only jointing material available. Rain would erode the sand if it wasn't replaced frequently, leaving parts open to vegetation growth.

TODAY - There are new types of sand-stabilizing compounds and polymeric jointing materials that relieve homeowners of this maintenance worry.

Finding the Right Fit

Even the best materials can be spoiled by subpar installation and craftsmanship, which is why choosing the right contractor for the job is the most crucial decision for your project. Remember that the cheapest quote is rarely the best option, so make sure to ask the right questions.



NEED HELP FINDING A QUALIFIED CONTRACTOR?

Unilock Authorized Contractors have met our exacting standards for installation methods and business practices. Connect with us online, by phone or at one of our locations and we'll be happy to connect you with a contractor in your area who is guaranteed to do the job right.



Register online at [Unilock.com](https://www.unilock.com) and we'll match you with a Unilock Authorized Contractor in your area.



8 Tips for Choosing a Contractor



1 WORKMANSHIP

Ask to see completed projects from more than two years ago to see how their work holds up.

Are the curves of the project cut in a way that minimizes large gaps? Are small or awkward cuts minimized?

Have edge restraints been used and are they still in place?

How long does the contractor guarantee their work?

Has there been a warranty claim filed against the company in the past two years?

2 SUB-CONTRACTING

Some contractors will hire other companies to perform parts of the work, like lighting and irrigation. Be sure to ask how these sub-contractors will be managed or vetted.



Scan here for a Project Planning Guide and helpful Contractor Checklist.

3 EXPERIENCE

How long has the contractor been installing pavers and walls?

Has the contractor installed projects in the past with the features you're considering?

4 PREPARATION

What are the contractor's base preparation methods?

What materials are used and why?

Is there a standard procedure for base preparation or will the contractor assess your site's unique needs?

5 SCHEDULE

How far in advance are projects being booked and how long might your project take?

What are the contractor's payment terms?

Do they require a deposit upfront to secure the timing of the project?

6 DOCUMENTATION

Does the contractor have the proper licensing for their work?

Does the contractor have liability insurance and are employees covered by Workers Compensation?

Will permits be required for the job and if so, who is responsible to secure them?

7 COMPATIBILITY

Do you like this contractor? Can you trust them? Can you easily communicate and understand each other?

Will the person you're meeting be on site throughout the project or will someone else be your day-to-day point of contact?

Contact references to help understand how your contractor will operate throughout a project.

8 DESIGN

Do they offer a design service? What is the cost for this?

Do they offer hand-drawn or 3D-rendered concept designs?

Are the contractor's designs something you would like for your project?

Time to Break Ground



1 EXCAVATION

All outdoor projects should begin with the removal of grass and topsoil. The depth will be determined by two things:

1. **Soil Type** - Sandier soil requires less excavation than clay-based soil.
2. **Use** - Patios and walkways, which take lighter loads should require less excavation than driveways and retaining walls, which require deeper excavation.

Depth of excavation can be reduced significantly if a layer of DriveGrid is placed at the bottom of the excavation before gravel gets placed. Loose subsoil should always be compacted prior to installing DriveGrid and gravel.



Learn about frequently used terms in the hardscape industry.

2 GRAVEL BASE

A gravel base is placed into the excavated area. Ideally, this gravel base will need to be:

- > **Strong enough** to support the weight of anything placed on the surface.
- > **Free draining** to allow water to escape the base and enter the subsoil. A perforated drain pipe in the gravel base may be necessary for retaining walls in order to direct water away from the wall's base.
- > **Extended** at least 6" (150mm) beyond the finished paver surface's edges.
- > **Compacted** in several layers, using the proper equipment.

3 BEDDING LAYER

On top of the firm gravel base, a 1" (25mm) layer of sand or tiny stone chips is spread out and smoothed. This layer enables the levelling or sloping of paver or wall units for drainage and smoothness.

Some contractors may recommend a poured concrete surface over a standard bedding layer, which is acceptable if the concrete is carefully poured and rests on a solid, well-drained base.

Note: Once concrete is poured, the height of paver or wall units can no longer be adjusted.



4 RESTRAINT SYSTEM

To prevent pavers from shifting, a concrete edge will be constructed or an edge restraint fixed with long metal spikes. For walls, adhesive can be used to secure rows of blocks together. Larger retaining walls may require geogrid every few layers to secure the wall into the soil that is being retained.

5 JOINT MATERIAL

There are three types of joint material to choose from:

Basic Jointing Sand – Years ago, this was the only joint material available. As it wears away, issues with weeds could arise. If you decide to choose basic sand, we advise using a joint stabilizing sealant and be ready to top up the sand as necessary.

Polymeric Sand – This special sand is blended with a binding ingredient to help it stay in place longer. Check with your local Unilock Dealer for the best jointing sand/compound for your project.

Resin Sand – Resin sands are the strongest jointing sand available, and have been proven to have the longest lifespan of any jointing sand. Different resin sands are available for various uses.

6 SEALING

Unilock pavers will be durable with or without a sealer. Some homeowners may choose to apply a sealer to enhance paver color, while others choose to appreciate the color of the pavers as they are. If you decide to seal, be prepared to re-seal your pavers every 3-5 years.

Factory-Sealed Products

Elegance® pavers and Unilock® pavers manufactured with EasyClean™ have been pre-sealed at the factory. To clean and brighten the surface at any time, a gentle power washing of the surface is recommended. If you wish to re-seal, wait a minimum of three years before applying sealant. Use only solvent-based sealants on factory-sealed products.

PAVER CONSTRUCTION

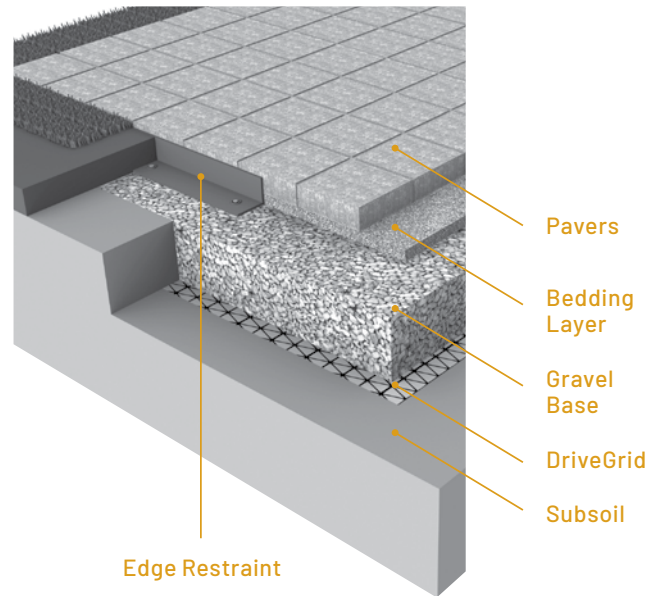

WALL CONSTRUCTION

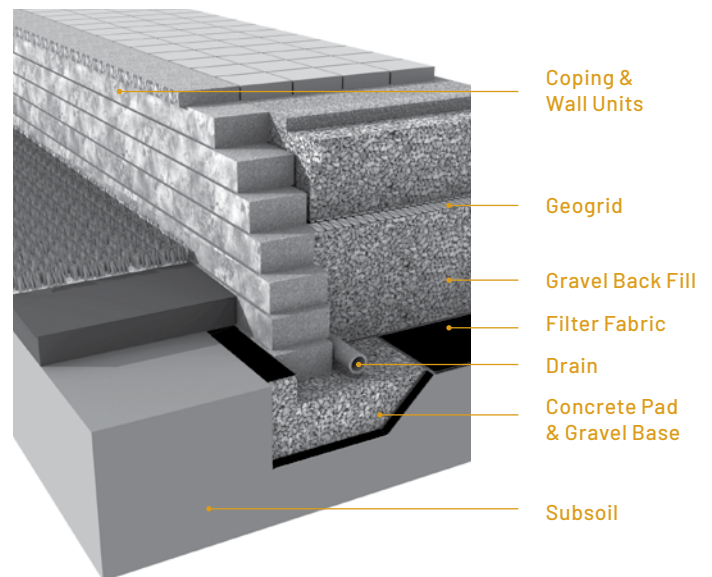

A proper base ensures that your pavers and walls won't shift during freeze/thaw cycles.

The Choice of Design Professionals

For decades, architects, landscape architects, and engineers have used the same Unilock products that are available to homeowners to design world-class commercial spaces across North America.





Indianapolis Motor Speedway, Indianapolis, IN Designer: Browning Day Mullins Dierdorf

Pier 4, Boston, MA
Designer: Mikyoung Kim Design



White Plains Public Library, White Plains, NY
Designer: IQ Landscape Architects

Our Quality Commitment



Unilock was the first concrete paver manufacturer in North America to offer a Lifetime Guarantee, and since then we have continued to stand behind it to ensure customers are completely satisfied with our products. With almost 2 billion stones in the ground, that's quite the commitment!

Our products are better and stronger than other brands. In fact, our internal standards of manufacturing in the USA and Canada far exceed industry standards set by ASTM (American Society for Testing and Materials) and CSA (Canadian Standards Association) and other European organizations.

LIFETIME GUARANTEE - RESIDENTIAL

Our Transferable Lifetime Guarantee warranties the structural integrity of Unilock concrete paving stones and retaining wall units when used in residential applications. It covers any structural failure or deterioration of the concrete unit resulting from normal use or from the reasonable application of sodium chloride (common rock salt used for de-icing). StoneMark™ products have the same warranties as Unilock paving stones and retaining walls, but cannot be warranted against damage resulting from de-icing products.

Any materials installed and maintained to our guidelines, and subject to normal wear, that prove defective, will be replaced without cost. Proof of purchase is required. Customers are encouraged to submit receipts to us as soon as their project is complete, using the Unilock

Warranty Registration Form on our website (Unilock.com).

Purchasers need to ensure that the product they purchase is appropriate for their intended application; for example, only certain thicknesses of products are appropriate for driveways. Color matching of the replacement product and/or lost time cannot be guaranteed and labor costs related to installing replacement product is not included. Unilock reserves the right to seek a professional diagnosis and opinion to determine the exact cause of the product failure. If the failure falls within our warranty parameters, Unilock will replace the defective product.

EXCLUSIONS – Unfortunately, some things are beyond the control of Unilock, and are therefore not covered by this warranty. These include: naturally occurring efflorescence, hazing from polymeric jointing sand, scratching and chipping resulting from snow removal or construction equipment, damage caused by natural or un-natural disasters, or negligence by anyone other than Unilock. While EasyClean helps to increase a paver's resistance to staining from various substances, it does not make our products stain-proof nor does it resist every kind of stain. The Unilock warranty also does not cover deterioration or damage as a result of poor design or poor installation practices that are contrary to specifications as laid out by ICPI (Interlocking Concrete Pavement Institute) and the NCMA (National Concrete Masonry Association). For more information please visit www.icpi.org and www.ncma.org. Additionally, please refer to the Maintenance, Color and Installation Advisories.

MAINTENANCE ADVISORY

1. Cleaning and Sealing

As with anything that is outdoors, Unilock products are subject to harsh weather, dust, acid rain, leaf stains, water stains and general wear from foot or vehicular traffic. Therefore, periodic cleaning using environmentally safe detergents designed for cleaning concrete is recommended to maintain a bright, fresh appearance.

To make subsequent cleaning easier and more effective, a concrete sealer can be applied to new or cleaned products to help prevent the penetration of substances that can cause stains.

There are many types of concrete cleaners and sealers on the market. Always read the instructions carefully before using the product to make sure that it will function as expected. Testing first, in a small unobtrusive area, is always a good idea to ensure the results are acceptable. Consult your local hardscape dealer to find the products best suited for your paver or wall installation.

2. Winter Maintenance

Snow removal by way of metal blades on plows or shovels will scratch and chip the surface of pavers, causing permanent damage. To mitigate this risk, metal snow clearing blades must always have a polyurethane or rubber cutting edge attached when plowing pavers.

De-icing Salts - The use of de-icing products on paver surfaces is important for safety and to help mitigate snow accumulation. Most de-icing products will have some effect on concrete, even if the product label indicates that it



Visit [Unilock.com](https://www.unilock.com) to register for your Transferable Lifetime Guarantee.

is safe on concrete. If you must use a de-icing product, we recommend that you use Sodium Chloride (ordinary rock salt) or Calcium Chloride (for colder climates). Always apply sparingly. The use of de-icing products on StoneMark, wet-cast pavers, slabs or coping may damage the product and therefore is not recommended. Whenever possible use a coarse sand as an anti-slip measure instead of de-icing chemicals.

COLOR ADVISORY

1. Selection

Due to the inherently variable nature of printed materials and digital monitors, Unilock cannot guarantee that products will match the color of printed or online images. Therefore, when making final product selections, decisions should be made based on actual stones which are readily available from Unilock, Authorized Contractors or Authorized Dealers. Most Unilock products are not comprised of a single color, but rather contain blended colors for a more natural appearance. This means that there will be significant color variance from stone to stone, so purchasers should view multiple units together to get a more accurate impression of the overall color.

Note: Unilock Natural Stone variations are outside the control of Unilock. Purchasers of natural stone must be willing to accept this inherent variability.

2. Pre-installation checking

Always check the label to ensure that the Unilock product delivered to your project is the product and color ordered. If there is a discrepancy, or if the product

inside the packaging doesn't appear to be correct, contact your hardscape dealer before installing any pavers or wall units. If the product is installed, it indicates your acceptance of the products as delivered.

3. Blending

If the project requires more than one bundle of product it's always a good idea to draw product from several bundles when installing, as this ensures that any variation between bundles will be seamlessly integrated in the project. When bundles are from different production runs, random selection from multiple bundles is even more important.

4. Efflorescence

Efflorescence is a naturally occurring process that may appear as a white or light grey powder on the surface of concrete, clay or natural stone. It is temporary, and will disappear over time. However, if it is bothersome, an efflorescence cleaner can be used to remove it. There is no way to predict or prevent efflorescence. Because it does not compromise the structural integrity of the product, it is not covered by Unilock product warranties.

INSTALLATION ADVISORY

1. Construction Residue

While a certain amount of dirt on pavers and walls is inevitable during the construction phase, installers are strongly encouraged to clean as they go as construction residue can embed in the surface and become difficult to remove. The slurry produced during wet-saw cutting is particularly stubborn to clean if allowed to dry on the surface of

pavers. Unilock warranties do not cover stains caused by a failure to remove construction residue.

2. Polymeric Haze

Surface hazing caused by polymeric jointing sand is not the responsibility of Unilock. Polymeric jointing sand should only be installed by an experienced and knowledgeable contractor. Any sand that is left on the surface prior to activation will result in a haze that is very difficult and time-consuming to remove. Only the highest quality, brand name polymeric sand that is guaranteed by the manufacturer should be used.

3. Compaction Damage

Both smooth and textured paver surfaces can be scratched by compaction equipment used to 'flatten' a new paver installation. Therefore, metal plate compactors must be fitted with a polyethylene mat to protect the paver surface from becoming scratched, or a superior option is to use a rubber-roller compactor instead. Damage to product surfaces caused by failure to follow these instructions is not covered by Unilock product warranties.

FIRE PIT WARNING

Wood-burning fire pits must be lined with a proper metal insert or refractory (fire-rated) brick to protect the concrete components from extreme exposure to heat. Extreme heat on a concrete surface may affect the structural integrity of the concrete and can be dangerous. The floor of the fire pit should always be constructed using refractory brick or a sand bed. For your safety, always use a spark screen over the fire.

Index

PAVERS

Artline™	109
Beacon Hill Smooth	91
Beacon Hill Smooth Slab	93
Beacon Hill™ Flagstone	95
Bristol Valley®	108
Brussels Block®	110
Copthorne®	153
Courtstone®	145
Eco-Priora™ Premier	132
Eco-Promenade®	133
Granito™	125
Granito Mix	126
Hex™	123
Hollandstone™	112
Holland Premier™	113
Il Campo®	130
Mattoni™	115
Metro™	103
Natural Stone	139
Nordic Cobble™	135
Northshore™	97
Porcelain Tile	137
Promenade EcoTerra™	127
Promenade™	129
Revela™	121
Richcliff®	141
Series™	131
Skyline™	107
Town Hall®	149
Treo® Smooth	111
Tribeca Cobble™	134
Umbriano®	117
Umbriano Slab	119
Urban™ Allure	106
Urban	105
Windermere Flagstone™	99
Windermere Smooth	101

COLLECTIONS

Beacon Hill	71
Metro	85
Umbriano	65
Urban	77
Windermere	81

RETAINING WALLS AND VERTICALS

Brussels Dimensional Stone®	170
Lineo™ Dimensional Stone	165
Pisa™	171
Pisa Smooth	169
Rivercrest™ Wall	167
SienaStone™	172
SienaStone Smooth	173
U-Cara®	159
U-Cara Modular System	162
U-Cara Wall Mount System	163

STEPS, TREADS, COPING & CAPS

Beacon Hill	183
Brussels Fullnose™	110
Ledgestone™	186
Natural Stone	187
SienaStone™	185
SienaStone Smooth	185
Pisa	184
Pisa Smooth	184
Umbriano Coping	183
Universal Coping	184
Urban	182
Urban Allure	182

TOPICS OF INTEREST

Borders & Accents	14
Coatings & Finishes	8
Classic	52
ColorFusion™	59
Construction Process	196
Contractor Tips	194
Coping	181
Creative Ideas	179
EnduraColor™	52
Elegance™	52
EasyClean™	58
Fire Features & Firepits	175
Joint Material	14
Laying Patterns	13
Maintenance	193
Outdoor Idea Center	190
Outdoor Kitchens	177
Permeable Pavers	55
Pillars	178
Reala™	57
Retaining Walls	157
Steps	181
Ultima™	56
Unilock Resources	192
Unique Touches	14
Uvision	191
Water Features	178

Unilock Ltd. and Hengestone Holdings, Inc. are the owners or authorized users of all trademarks used in this publication unless otherwise specified. Umbriano® are trademarks of Metten Stein + Design GmbH & Co KG used under license by Unilock®. Measurements throughout this portfolio are nominal. Not all products shown are available at all Unilock locations. Log on to Unilock.com for availability. Colors shown in this catalog should be used only as a guide. Colors should always be chosen from actual samples. Contact your local Unilock representative for color availability in your area.



FOLLOW US

     @Unilock   @UnilockLife





**TRANSFORMING
HARDSCAPES**

BOSTON

(508) 278-4536

CHICAGO

(630) 892-9191

MILWAUKEE

(262) 742-3890

KANSAS

(913) 417-7985

MICHIGAN

(248) 437-7037

NEW YORK

(845) 278-6700

MID-ATLANTIC

(202) 798-2060

ONTARIO

(416) 646-9000

QUÉBEC

(450) 546-2797

CINCINNATI / KY / TN

(513) 202-0219

OHIO/WESTERN PA

/ WNY&CNY
(330) 927-4000



UNILOCK.COM
1-800-UNILOCK