



SienaStone[®]
segmental retaining wall

Installation Guide



RisiStone[®]
retaining wall systems



SienaStone® combines the stability of large modular units with the popular natural rock-like appearance







Steps, corners, angles and curves
can easily be built with light
construction equipment



introduction

- The SienaStone® System 3
- Block Details 5
- Overview of a Successful Project 6
- Following the Design 7

installation

- SienaStone System Clamp 10
- Single-Depth Conventional SRW Installation Procedure 11
- Multi-Depth Conventional SRW Installation Procedure 14
- Reinforced SRW Installation Procedure 15
- Alternate Backfill Materials 19
- Vertical Walls 20

details

- Corners 22
- Curves 35
- Fences and Rails 36
- Drainage 38
- Obstructions 42
- Steps 43
- Terraces 45
- Finishing Details 46

© 2013 by Risi Stone Systems
 All rights reserved. Published 2013
 Printed in Canada

Risi Stone Retaining Wall Systems
 8500 Leslie Street, Suite 300, Thornhill, ON L3T 7M8 Canada
 1.800.626.WALL • info@risistone.com • www.risistone.com

Risi Stone Systems has attempted to ensure that all information contained in this guide is correct. However, there is the possibility that this guide may contain errors. Review all designs with your local sales representative prior to construction. Final determination of the suitability of any information or material is the sole responsibility of the user. Please check our website www.risistone.com, for the most up-to-date versions of the specification.

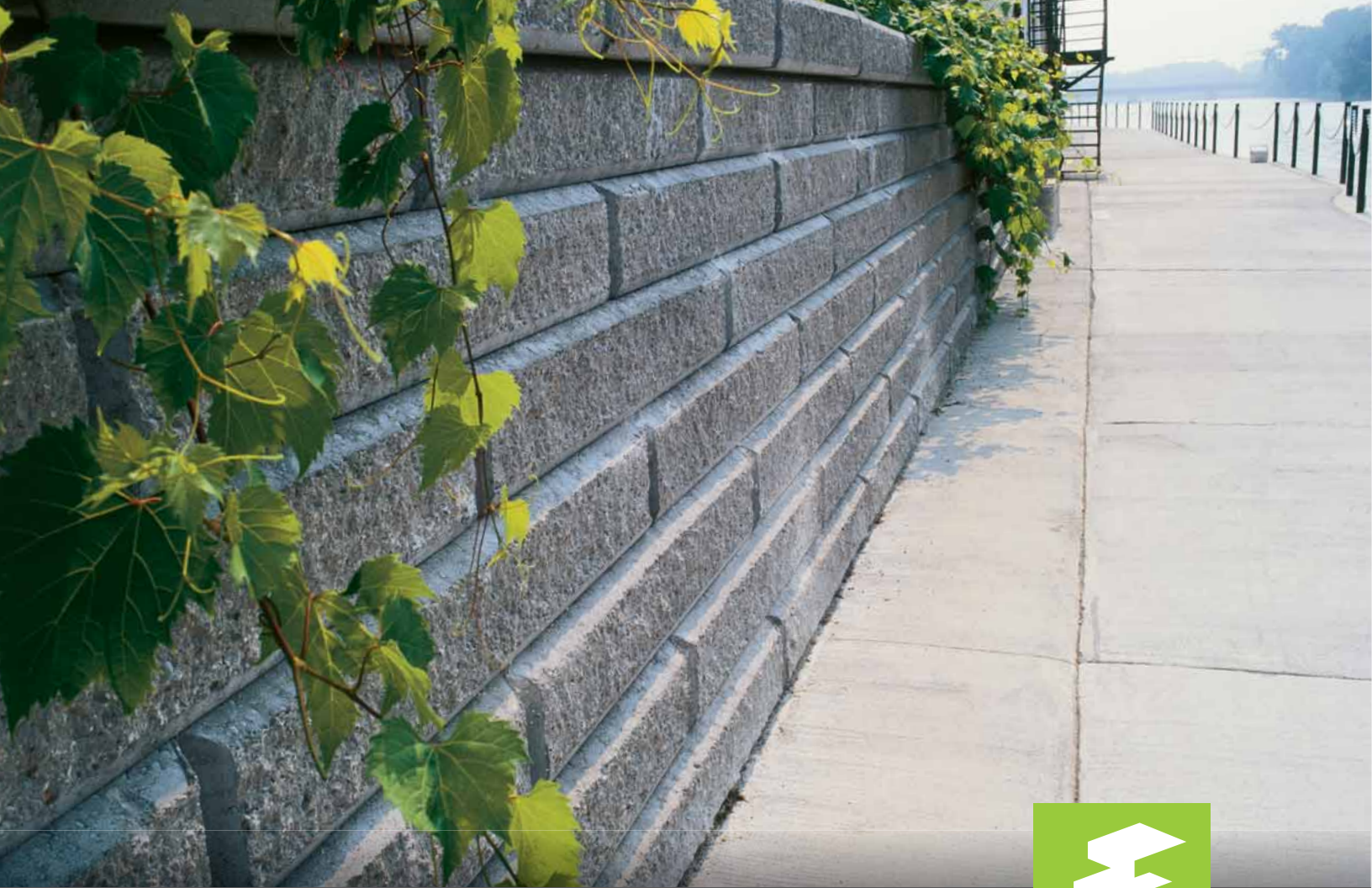

introduction

the SienaStone® system	3
block details	5
overview of a successful project	6
following the design	7



The SienaStone system is a solid, modular concrete retaining wall system that is used to stabilize and contain earth embankments, large or small.

Today, the SienaStone system and several other retaining wall systems licensed by Risi Stone Systems are manufactured and installed across North America and internationally.

In the SienaStone system, the majority of the facing is constructed from a single mass-produced modular unit. Because the units are solid, they can easily be modified by scoring and splitting. Specialized units are available to help speed the installation of wall features like coping units and corner units. The SienaStone system can be constructed in three basic configurations: a SienaStone Conventional SRW (single or multi-depth) or a SienaStone Geogrid Reinforced SRW.

There are many applications for SienaStone retaining walls. Most examples can be divided into the three aforementioned configurations which, more or less, follow two basic uses: landscape applications and structural applications.

In landscape applications, the primary purpose of retaining walls is aesthetic in nature. Some examples of SienaStone landscape uses are steps and terraced applications. Most landscape applications call for walls under 1.2 m (4 ft) in height, with minimal loads being applied to the wall. Consequently, most landscape walls are built as conventional SRWs.

In structural applications, the primary function of retaining walls is to provide structure and strength to steep slopes or cuts. Some common structural uses for SienaStone retaining walls are high walls, some in excess of 7.5 m (25 ft); walls required to support parking, roads, or highways; and erosion protection along streams or lakes. In most of these cases, geosynthetic reinforcement is used or multi-depth conventional construction is required. Multi-depth conventional SRWs utilize deeper base course units to increase the maximum allowable wall height. This configuration is particularly useful for construction in tight spaces (e.g. close to a property line).

The SienaStone system is supported by the local manufacturer and Risi Stone Systems. The local manufacturer will make every attempt to answer general questions and they will gladly provide customers with answers for site-specific applications. Each manufacturer has access to prepared

information on the SienaStone system and has plenty of experience installing it. The Vespa.RS design software also helps to provide solutions for specific site designs. Unique applications often necessitate the assistance of a professional engineer. Risi Stone

Systems can provide these solutions through its Engineering Design Assistance program.



feature and advantages

The SienaStone system has a number of features that make the system unique. Each of these features has been developed to give a SienaStone retaining wall the advantages of increased beauty, simplified installation, and greater strength. These features benefit the owner by lowering the entire cost of the retaining wall, both during installation and well into the future.

Modular Retaining Wall System

Wall is flexible, yet retains its structural characteristics.

- The wall can absorb minor movements due to frost or settlement.
- Requires minimal embedment below grade.

A compacted granular base is all that is required.

- Reduces the cost by not requiring an expensive structural footing.

Solid Unit Manufactured From 35 MPa (5000 PSI) Concrete

Provides wall with greater durability.

- Ensures the maximum weight of each unit because there are no voids or cores to be filled.
- Less susceptible to freeze-thaw deterioration.
- Less likely to be broken by handling or in transit.

Solid units are easy to split and modify.

- Can easily create site-specific features using the modular units.

No hollows to be filled with gravel and compacted.

- Ensures maximum resistance to overturning forces.
- Saves time and money.

Tongue and Groove Interlock

Interlocking mechanism molded into the units so there are no separate pins or clips.

- No need to incorporate multiple components; installation rates increase.
- Ensures maximum shear connection between units.

Units are dry-stacked.

- Lower costs because no mortar is used in the construction.
- Minimal training is required to achieve excellent installation results.

Units are self-aligning and self-battering.

- Once the first course is laid flat and levelled, subsequent courses automatically align horizontally and vertically.

Creates a continuous interlock throughout the wall.

- Makes a stronger, more damage-resistant wall.

Size and Weight

The SienaStone units range in weight from 143kg (315lbs) up to 450kg (1102lbs). As a result, these units must be machine-placed. (Refer to *Installation–SienaStone System Clamp* for instructions on use of the mechanical placement clamp.)

SienaStone with Geogrid Reinforcement

Ability to construct higher walls.

- Can utilize site soil to infill the geogrids, consequently lowering disposal and extra material charges.
- Can use the same facia throughout a site on lower conventional SRWs and higher geogrid reinforced SRWs.

Choice of Configurations

- Walls on one site with different structural requirements can have the same appearance.

90° and 45° Corner Units

Manufactured to speed construction.

- Offers a finished appearance to the wall.
- Initiates the correct running bond pattern.
- Increases the strength of corners.
- Saves time during installation.

Complementing Accessories

All the standard features for retaining walls can be supplied by the manufacturer.

- Saves time during installation.
- Creates a uniform, finished look for the wall.

Technical Support and Engineering Design Assistance

Technical expertise developed over thirty years through experience and testing is available to customers.

- Ensures that retaining walls are correctly designed and constructed.
- Advanced software is available to help designers generate designs for stable retaining wall structures.



Due to local conditions and preferences, the licensed manufacturer may produce the SienaStone system with one or more minor variances. These differences in no way affect the performance of the wall.

colours

The set of standard colours that are made and kept in stock will vary from manufacturer to manufacturer. Some have the ability to mix the base colours and create marbled colour blends. The possibility of custom colours may exist for larger orders.

closed-end coping

Some manufacturers produce closed-end coping units that can be used to hide the groove in the bottom of the coping unit at locations where the retaining wall steps up or down.

one metre width unit

Due to the limitations of the manufacturing machinery, manufacturers may opt to produce the slightly shorter, one-metre version of SienaStone.

SienaStone® System Units	Width	Height	Depth	Weight
 Standard 500	1200 mm (48 in)	185 mm (7.25 in)	500 mm (20 in)	259 kg (570 lbs)
	1000 mm (39 in)	185 mm (7.25 in)	500 mm (20 in)	210 kg (463 lbs)
 333	1200 mm (48 in)	185 mm (7.25 in)	333 mm (13 in)	172 kg (379 lbs)
	1000 mm (39 in)	185 mm (7.25 in)	333 mm (13 in)	143 kg (315 lbs)
 925	1200 mm (48 in)	185 mm (7.25 in)	925 mm (36 in)	450 kg (1102 lbs)
	1000 mm (39 in)	185 mm (7.25 in)	925 mm (36 in)	366 kg (895 lbs)
 Half Taper	N/A	N/A	N/A	N/A
	Face 500 mm (20 in) Back 435 mm (17 in)	185 mm (7.25 in)	500 mm (20 in)	100.5 kg (221 lbs)
 90° Corner	1100 mm (44 in)	185 mm (7.25 in)	500 mm (20 in)	238 kg (525 lbs)
	900 mm (35 in)	185 mm (7.25 in)	500 mm (20 in)	194 kg (426 lbs)
 45° Corner	856 mm (34 in)	185 mm (7.25 in)	500 mm (20 in)	150 kg (330 lbs)
	856 mm (34 in)	185 mm (7.25 in)	500 mm (20 in)	150 kg (330 lbs)
 Coping	1200 mm (48 in)	185 mm (7.25 in)	500 mm (20 in)	259 kg (570 lbs)
	991 mm (39 in)	185 mm (7.25 in)	500 mm (20 in)	210 kg (463 lbs)
 Corner Coping	1100 mm (44 in)	185 mm (7.25 in)	500 mm (20 in)	237 kg (523 lbs)
	891 mm (35 in)	185 mm (7.25 in)	500 mm (20 in)	193 kg (425 lbs)

* Grey measurements are for the shorter width units available in some locations. The SienaStone 333 unit can be used in place of the standard 500 unit in the following details. All standard corner and coping units are to be used with the 333 unit as part of the system.



The following procedure is recommended for the construction of SienaStone segmental retaining walls over 1.2m (4.0ft) in height, or as required by local building codes.

Clear Site Plan

- Aboveground Site Assessment and location of existing grades, structures, utilities, property lines, visible water features, etc., identified.
- Proposed site modifications defined by designer (landscape architect, engineer, architect) based on owner's requirements and site limitations. Includes proposed grades, retaining wall geometry, slopes, proposed use of land (parking areas, water detention, landscape), relocation of existing structures/utilities, new structures/utilities, location of trees, etc.
- Project drawings generated and submitted to appropriate agencies for approval.

Assessment of Subsurface Conditions

- Geotechnical Investigation conducted to evaluate subsurface conditions of site, including soil types, characteristic properties, in-situ state, groundwater conditions, overall slope stability, bearing capacity.
- Recommended design parameters, construction/excavation techniques, effects of proposed and existing structures, ground improvements, erosion protection, drainage considerations, anticipated settlement, etc., should be identified.

Site-Specific Retaining Wall Design

- Information provided in Plan and Geotechnical Investigation submitted to SRW designer.
- The design may be provided by Risi Stone Systems through the Design Assistance Program (contact local manufacturer for details), or a third-party engineer qualified in this field. The design must synthesize all available information and include cross-section and/or elevation-view drawings, specifications, calculations, quantities, and related construction details. (*See Following the Design*)

Qualified Professional Engineer Hired for Inspection/General Review

Inspection and General Review of the proposed SRW must be conducted by a qualified third-party engineer.

Inspection is more than soil and compaction testing, but includes all aspects of the installation. The scope of the General Review Engineer's (GRE) responsibilities include, but are not limited to:

- Inspection of all materials used in construction (SRW units, backfill, drainage materials, reinforcement, other structures);
- Verification that the design is compatible with the site in all respects;
- Identification of discrepancies between project plans and/or SRW design and actual site conditions and subsequent notification of designer;
- Continuous evaluation of site conditions, compaction testing, foundation bearing capacity, excavation procedures, construction practices for safety and compliance with design;
- Ensuring the wall is constructed according to the design;
- Providing a letter to the owner certifying the construction of the wall upon completion.

Pre-Construction Meeting

- It is recommended that all involved parties (designers, owner's representative, general contractor, installer, inspecting engineer, supplier, etc.) attend a pre-construction meeting to define schedule and clearly state responsibilities.
- Parties not directly involved with the design and construction of the wall, but who may be doing future work that could influence the wall (e.g. paving, installing fences, etc.) should be included in the meeting to understand the limitations of the wall and address precautions that should be undertaken.
- Experience has shown that this simple step prevents a multitude of potential problems!

Proper Installation

- Adherence to design, specifications, details, guides, and good construction practice is necessary.
- Conducted under supervision of GRE.

Final Grading

- Final grading should be conducted as soon as possible following construction to divert water away from the wall and create the optimum condition for great performance.



understanding the design

Depending on the stage in the design process, there are generally three potential types of design:

Typical Design

Non-site-specific design(s) selected from Risi Stone Systems' library of pre-engineered cross-section drawings (all available at risistone.com). Selected based on preliminary information regarding proposed maximum wall height, use of structure, grading, etc. Suitable for preliminary cost estimates, feasibility studies and conceptual approvals.

A "Typical Design" should not be used for construction.

Preliminary Design

A site-specific design produced for preliminary purposes. Conducted when some details of the required design information is not yet available. The design includes all elements necessary to construct the wall, but is not considered ready for construction as it remains contingent on verification of some

site-specific detail(s). Includes site-specific cross-section drawing(s), elevation view(s), specifications, quantity calculations, details, statement of limitations, etc. This type of design is usually not sealed by the designer.

Final Design

Identical to the preliminary design with the exception that all necessary information has been established and the design has been deemed ready for construction. This type of design is normally sealed by the designer.

components of the design

The design should clearly provide all information necessary to construct the proposed SRW structure. The basic components are as follows:

Design Notes / Limitations

The design should include information regarding the design standard used, limitations of design, status of design (preliminary or final), design assumptions, purpose of the wall, and potential construction issues.

Typical Cross-Section Drawing

TYPICAL SECTION - NOT FOR CONSTRUCTION

Design Specific Geometric Information			
Retaining Wall System	SienaStone w/ Geogrid	Geogrid Type and Manufacturer	See Notes
Maximum Height mm (in)	3520 (138)	Minimum Geogrid LTDS kN/m (lb/ft)	See Notes
Maximum Slope Above Wall	1V:3H	Maximum Slope Below Wall	None
Max. Surcharge Above Wall kPa (lb/sq.ft)	None	Depth of Embedment mm (in)	351 (14)
Batter of Wall	7.12 °	Compacted Base Dimension mm (in)	879 x 186 (35 x 7)

Description (By USCS)	Soil Region				
	Infill	Retained	Foundation	Base	Drainage
GW Well graded, free draining Granular	CL Inorganic Clays Low Plasticity	CL Inorganic Clays Low Plasticity	GW Well graded, free draining Granular		see infill
Effective Internal Friction Angle	35 °	28 °	28 °	39 °	NR
Moist Unit Weight kN/cu.m (lb/cu.ft)	22 (140)	20 (127)	20 (127)	22 (140)	NR
Effective Cohesion kPa (lb/sq.ft)	NR	NR	NR	NR	NR
Soil Notes	Placed in 150mm (6") lifts and compacted to 95% SPD.	Undisturbed dense soil or well compacted Eng. fill.	Allowable bearing cap. must exceed 150kPa (3125 psf).	Crushed Gravel (free draining) compacted to 98% SPD.	Gravel infill must be well graded, angular, free drain min. max. 5% fines.

Notes:
 NR - Not Required
 1. This design meets or exceeds the minimum factors of safety required by Risi Stone Systems based on the design parameters listed above. The analysis was performed as outlined in the National Concrete Masonry Association Design Manual for Segmental Retaining Walls, Second Edition. This is a typical, non site-specific Design.
 2. No analysis of global stability, total or differential settlements, or seismic effects has been performed.
 3. This design is only provided to illustrate the general arrangement of the SRW structure for preliminary costing and feasibility purposes only. This drawing is not for construction. A qualified Engineer must be retained to provide the Final Design prior to construction.
 4. Structures such as handrails, guardrails, fences, terraces, and site conditions such as water applications, drainage and soil conditions, additional live and dead loads, etc., have significant effects on the wall design and have not been taken into account in this typical section. When accounted for in the Final Design, other conditions and elements may result in additional design measures (geogrid, drainage, etc) and cost.
 5. For geogrid reinforced structures, a minimum Long Term Allowable Design Strength of 14 kN/m was assumed. Contact your manufacturer or Risi Stone Systems for a list of approved geogrid reinforcements.

8500 Leslie Street, Suite 390
 Thornhill, ON Canada L3T 7M6
 Phone: 905.882.5898 Fax: 905.882.4556
 www.risistone.com
 © 2007 Risi Stone Systems

SienaStone®
 Retaining Wall
 Geogrid Section
 3520mm (11.54ft)
 Site: 3H:1V Slope - Clays
 Infill: Granular
 SS2RBSAI352

Cross-Section Drawing(s)

The cross-section drawing is usually provided to illustrate the general arrangement of the wall, soil zones, assumed parameters, other structural elements such as fences and handrails, water levels, etc. The cross-section drawing is normally provided for the maximum height section through the wall and/or the most critical section. Additional cross-sections may be provided to indicate variable conditions or wall orientation (terraces / location of an obstruction) throughout the structure.

Elevation-View Drawing(s)

The elevation view or “face” view of the wall depicts the wall as a whole, essentially laying the wall out flat on the page. This drawing details the overall geometry of the proposed wall, stepping at the top and bottom of wall, required geogrid length and placement (where applicable), location of other structures, etc. This drawing provides the contractor with an exact model upon which to establish grades and construct the wall.

Calculations and Quantity Estimates

Risi Stone Systems conducts analysis using the Vespa.RS design software (available at risistone.com), a branded version of the popular Vespa MSE Design

Software. Risi Stone Systems’ design reports feature the Vespa design output. This output is customizable and depending on the application, may include the design calculations, all design parameters, quantity calculations, etc. The quantity calculations exactly represent the wall layout provided in the elevation view and Calculated Panel Geometry section of the Vespa.RS output. The contractor is responsible for verifying the quantities provided by checking the most recent grading information, and/or site grading against the elevation view provided.

Details

The cross-section and elevation-view drawings are to be used in conjunction with the related detail drawings. These may include handrail treatments, corner details, curves, stepping foundation, steps, swales, etc. Adherence to these details is vital for optimum wall performance.

Specifications

The Design should include standard specifications that outline specific requirements of the Design, Construction, Materials, Certification, and Finishing.

Typical elevation-view drawing

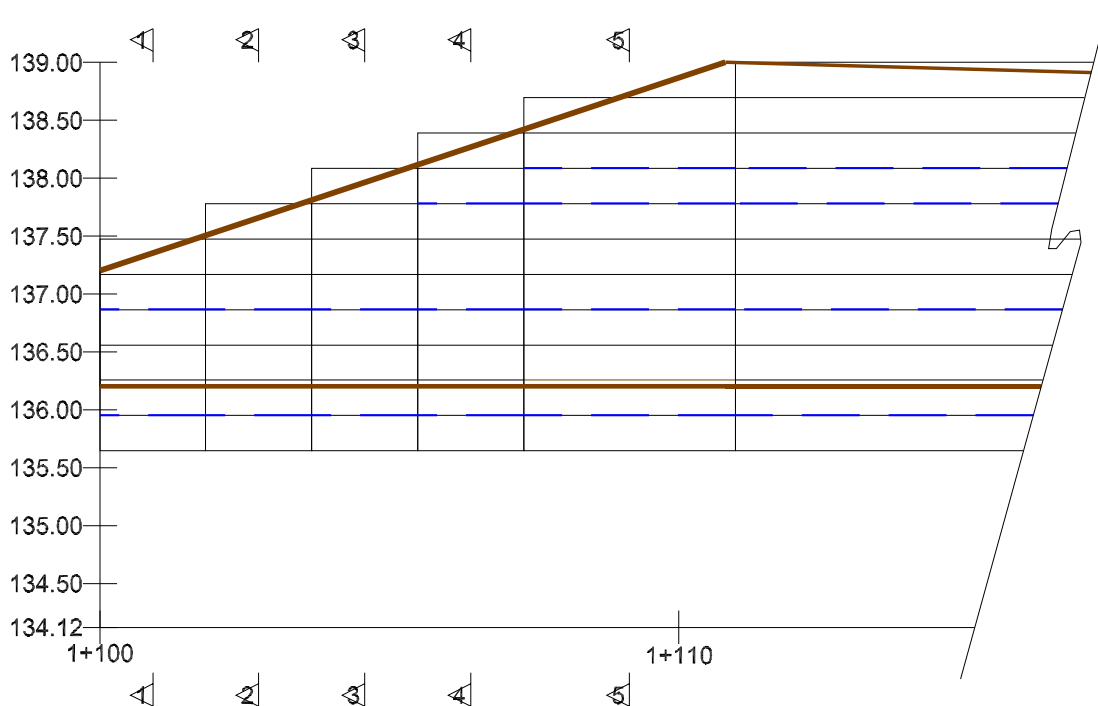



installation

SienaStone system clamp	10
single-depth conventional srw installation procedure.	11
multi-depth conventional srw installtion procedure	14
reinforced srw installation procedure.	15
alternate backfill materials	19
vertical walls	20



operating instructions

Other variations of this type of clamp exist, the following illustrates one type of configuration.

Place clamp on unit.



Rotate Locking bar up.

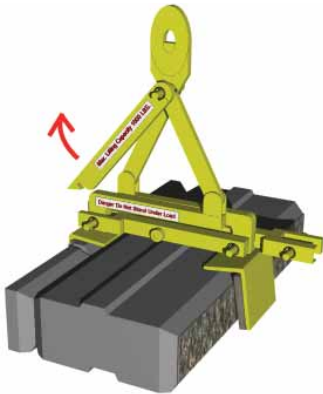

Lift clamp with machinery.



Place unit in desired location. Once set in place, rotate locking bar back to centre peg. This restrains the clamp from closing. Lift clamp away from block.

notes and precautions

This is a mechanical scissor clamp. This device uses the self weight of the unit to apply the necessary confining pressure on the block. It requires no power other than that provided by the lifting machinery (ie. backhoe, bobcat, etc.).

This design of the SienaStone clamp makes it compatible with all the SienaStone components. The unit may be picked up with the pads on the face of the block or rotated 90 degrees to pick it up from the ends.

As with any clamp, proper care should be taken to reduce the likelihood of injury.

- The maximum recommended load should not be exceeded
- At no time should anyone stand under the load
- Prior to each use the pads should be inspected to ensure that they are good condition
- Proper overall maintenance of the clamp is crucial

extended clamp with 925 unit

Note the use of small locking bar.

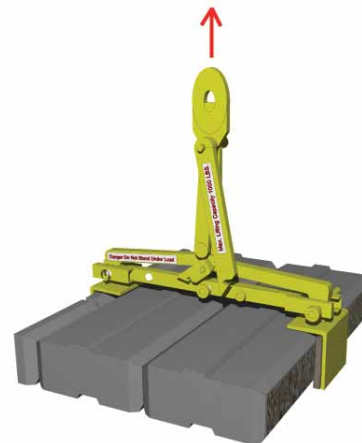



single-depth installation procedure

The following are the basic steps involved in constructing a conventional (non-geogrid-reinforced) SienaStone Segmental Retaining Wall. These steps are to be used in conjunction with all relevant details provided in the *Details* section of this book.

Refer to Overview of a Successful Project before beginning. This will ensure the project goes smoothly.

plan

With your final design in hand and General Review Engineer (GRE) close by, begin to establish the wall location and proposed grades. Locate all utilities and contact local utility companies before digging. Mark a line where the front of the wall will be placed, keeping in mind the 25mm (1 in) setback per course.

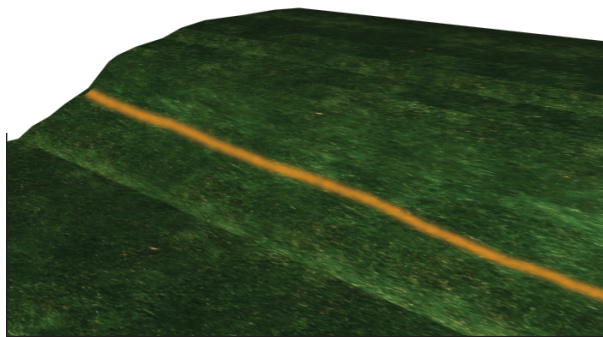

excavate

Excavate a trench down to the foundation grades specified in the design. The front of the trench should be 185mm (7.25 in) from the planned face of the block. The trench should be a minimum of 1055mm (40 in) wide (front to back) and 370mm (14.5 in) deep. This depth assumes one unit is buried (unit height of 185mm [7.25 in]) plus the compacted granular base minimum depth of 185mm (7.25 in). As the wall height increases, depth of embedment also increases, normally about 10% of the wall height. Greater embedment depths may be required to account for slopes more than 3H:1V in front of the wall, scour protection in water applications, global stability, or as specified in the design. The rear 185mm (7.25 in) of the trench is excavated to account for the drainage layer. Excavations should be conducted in accordance with local codes under direction of the GRE.

verify foundation subgrade

Once the foundation trench has been excavated to the specified elevations, the native foundation soil must be checked by the GRE. The foundation soil must have the required allowable bearing capacity specified in the design.

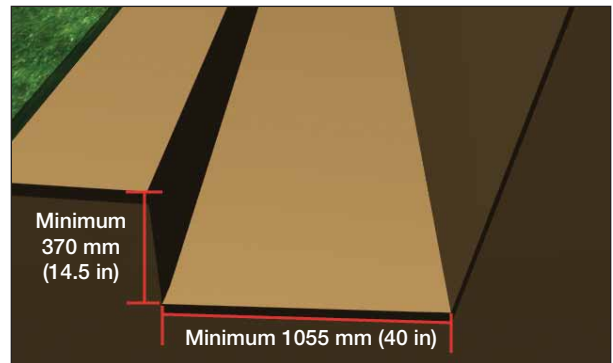

prepare the granular base

Start the base at the lowest elevation of the wall. The base should be composed of well-graded, free-draining (less than 8% fines), angular granular material, and compacted to a minimum of 98% SPD. The minimum base thickness is 185mm (7.25 in) or as required by the GRE to reach competent founding soil. A layer of unreinforced concrete (50mm [2 in] thick) may be placed on top of the granular material to provide a durable levelling surface for the base course. At the direction of the GRE, geotextile might be required under the granular base. The minimum base dimensions at the top are 870mm (34 in) wide (front to back) and 185mm (7.25 in) deep. The additional 185mm (7.25 in) trench width allows for the placement of the drain.

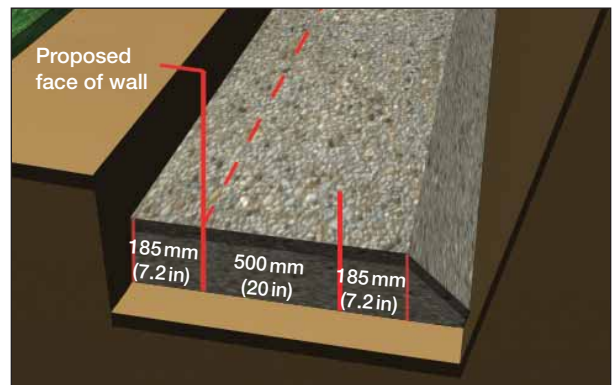

step the base

When the grade in front of the wall slopes up or down, the base must be stepped to compensate. Working out the stepped base as the wall steps up in elevation, the foundation steps must be located to ensure the minimum embedment is achieved. The height of each step is 185mm (7.25 in) – the height of 1 course. The 25mm (1 in) offset must be accounted for at each step.

Refer to “Stack the Units” on the following page for an illustration of stepping the base.

place filter cloth

Lay the approved filter fabric (geotextile) along the bottom of the rear of the trench and extend up the exposed excavation to the proposed wall height. Leave adequate material at the top to fold back towards the wall (completely containing the drainage material). Stake the filter cloth against the slope during construction.

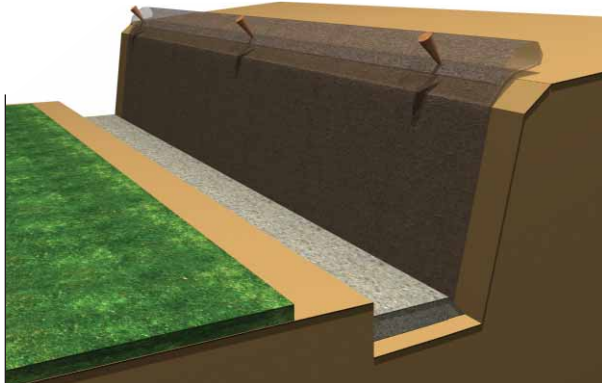

place the drain

Various options for drain placement may exist, depending on how the pipe is to be outlet (refer to *Details – Drainage*). The drain may be outlet through the wall face or connected to a positive outlet (storm drain). The drainage system is extremely important and outlets must be planned prior to construction. In the case of connecting to a positive outlet, the drain should be placed at the lowest possible elevation and sloped at a minimum of 2%. At the rear of the base, allow the granular material to slope down on the sides towards the drain trench. In the 185mm (7.25 in) area behind the base, place the approved drain tile (perforated drain with filter sock) on top of the filter cloth and minimal granular coverage.

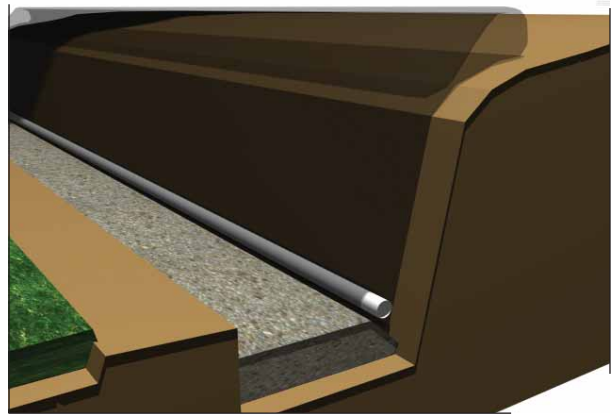

place the first course

Position a level string to mark location of the back of the first course (should be 500mm [20 in] from the proposed wall face). Place the first course of SienaStone units side-by-side (touching) on the granular base. Ensure units are level front to back and left to right. Extra care should be taken at this stage as it is critical for accurate alignment.

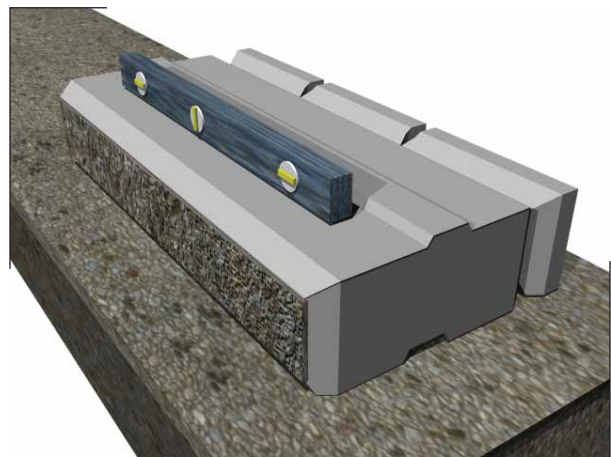
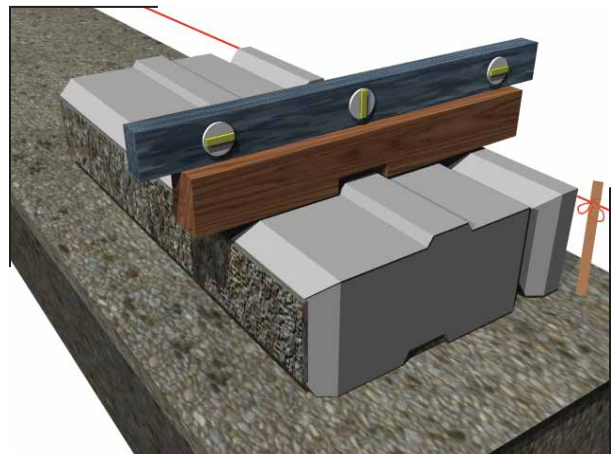

stack units

Sweep top of underlying course and stack next course in a running bond pattern so that middle of the unit is above the joint between adjacent blocks below (500mm [20in] offset).

[NOTE: When certain details – such as corners and curves – are incorporated into the wall the running bond pattern may shift slightly. A small deviation of up to +/- 250 mm from the perfect running bond pattern is allowable. However, this deviation should be corrected as soon as the wall layout allows.]

Continue stacking courses to a maximum of 4 courses (740mm [29in]) before backfilling.

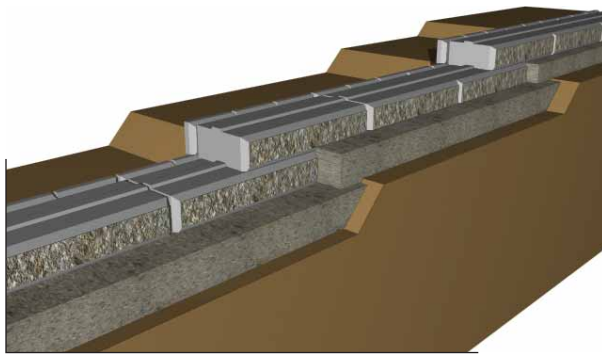

backfill drainage material

A free-draining, 19mm (¾ in) clear stone drainage material is placed immediately behind the wall facing and compacted with a light manual tamper. The drainage layer must be a minimum of 300mm (12 in) thick and protected from the native material by the filter cloth.



continue stacking and backfilling

Continue placing the SienaStone units and backfilling as described until the desired wall height is reached.

encapsulate the drainage layer and finish grading

Fold the excess filter fabric over the top of the drainage layer and extend up the back face of the coping unit. Ideally, place an impervious layer of soil on top of the filter fabric and compact manually, providing for the required grading and/or swales. For other treatments such as pavers, concrete, or asphalt, care must be taken to ensure that heavy compaction/paving equipment remains a minimum of 1.0m (3.0 ft) from the back of the coping unit. Slope the surface above and below the wall to ensure water will flow away from and not accumulate near the wall units. See the *Details* section for ideas on tapering down and ending the wall.

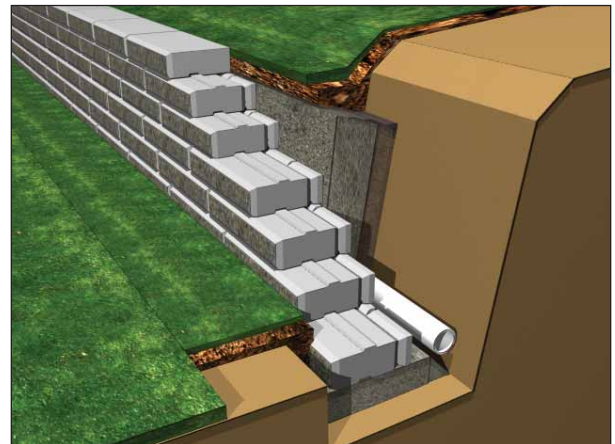



Utilizing the 925 units to create a multi-depth conventional wall allows greater heights to be achieved without the necessity of geogrid reinforcement. This method can be valuable when the proposed wall is in close proximity to a property line or obstruction, and the space for geogrid placement is limited. The procedure for a multi-depth conventional wall is the same as for the single-depth wall described previously, however, the following steps are slightly different. This is required because as the depth of the block is larger, the base dimensions are altered.

excavate

The width (front to back) of the trench must be increased to 1445mm (57 in) to allow for the larger 925 unit.

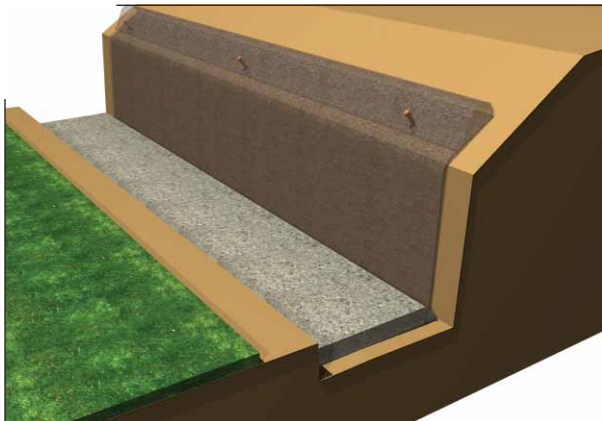

prepare the compacted granular base

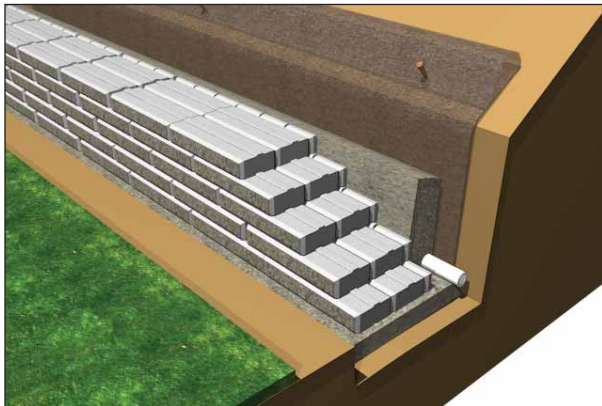

The minimum dimensions of the 925 unit granular base are 1295mm (51 in) wide (front to back) and 185mm (7.25 in) deep.

stack units

The 925 units are to be stacked in a running bond pattern as described in the previous section. Once a specified number of 925 courses have been stacked (dependent on site conditions such as loading, soil, etc.), the standard 500 units can be placed on the top. Utilizing the 500 units for the top courses will reduce the cost of materials and reduces the overall cost of the project.

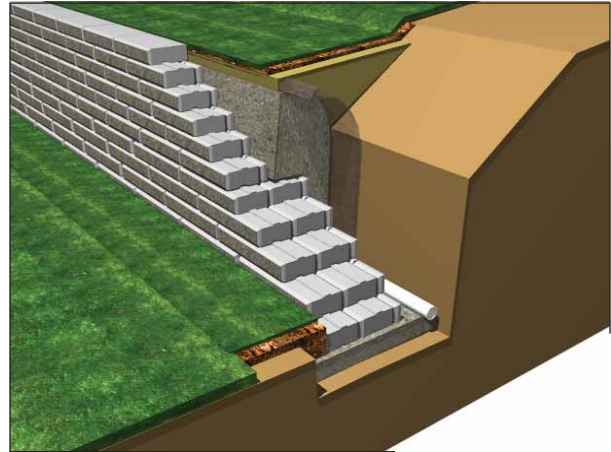



The following are the basic steps involved in constructing a reinforced SienaStone Segmental Retaining Wall. These steps are to be used in conjunction with all relevant details provided in the *Details* section of this book.

Refer to Overview of a Successful Project before beginning. This will ensure the project goes smoothly.

plan

Before beginning construction, be sure to have a final design and arrangements made for a General Review Engineer (GRE) to be present. Begin to establish the wall location and proposed grades. Locate all utilities and contact local utility companies before digging. Mark a line where the front of the wall will be placed, keeping in mind the 25mm (1 in) setback per course.

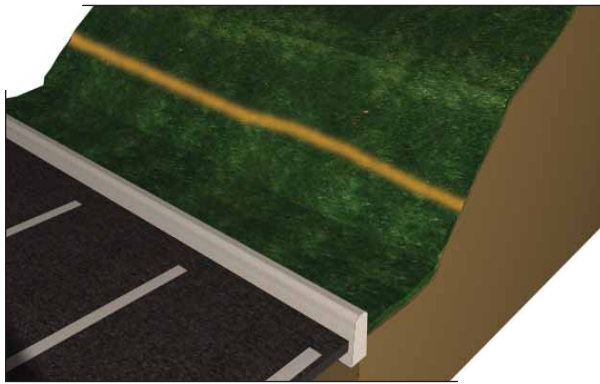

excavate reinforced zone

The excavation must be carefully planned and consider several elements. Based on the type of soil being excavated, the GRE must determine the maximum allowable “cut” angle the excavation can sustain. This angle ensures the stability of the excavation during construction. The required geogrid length (as shown in the design) plus 185mm (7.25 in) defines the minimum width at the base of the excavation. Measuring from 185mm (7.25 in) in front of the wall face, extend a line back a distance equal to the base width determined above. Before excavating, consider structures and trees that may be impacted by the excavated slope.

Excavation continues until the slope is cleared and a flat area at the base is exposed extending 185mm (7.25 in) past the proposed face of the wall.

excavate granular base

Excavate a trench for the granular base. The front of the trench should be 185mm (7.25 in) from the planned face of the block. The trench should be a minimum of 1055mm (40 in) wide (front to back) and 370mm (14.5 in) deep. This depth assumes one unit is buried (unit height of 185mm [7.25 in]) plus the compacted granular base minimum depth of 185mm (7.25 in). As wall height increases, depth of embedment also increases, normally about 10% of the wall height. Greater embedment depths may be required to account for slopes more than 3H:1V in front of the wall, scour protection in water applications, global stability, or as specified in the design. The rear 185mm (7.25 in) of the trench is excavated to account for the drain.

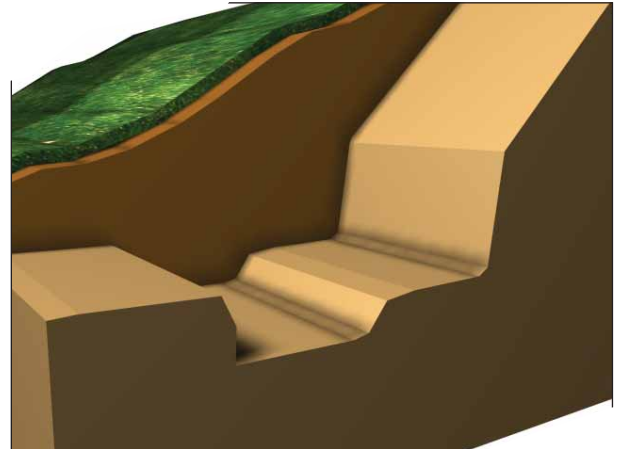

verify foundation subgrade

Once the wall has been excavated, the native foundation soil must be checked by the GRE. The foundation soil in a geogrid-reinforced SRW is considered to be the material underneath both the facing and reinforced zone – that is, the entire wall footprint. This verification should not just be limited to the soil underneath the granular footing. The foundation soil must have the required allowable bearing capacity specified in the design.

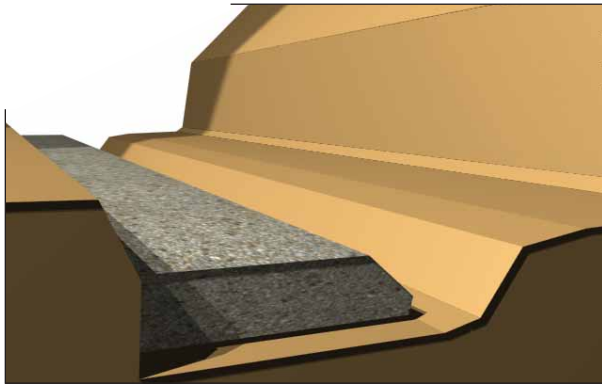

prepare the granular base

The base should be started at the lowest elevation of the wall. The base should be composed of well-graded, free-draining (less than 8% fines), angular granular material, and be compacted to a minimum of 98% SPD. The minimum base thickness is 185mm (7.25 in) or as required by the GRE. A layer of unreinforced concrete (50mm [2 in] thickness) may be placed on top of the granular material to provide a durable level surface for the base course. The minimum base dimensions are 870mm (34 in) wide (front to back) and 185mm (7.25 in) deep. The additional 185mm (7.25 in) trench width allows for the placement of the drain.

step the base

When the grade in front of the wall slopes up or down, the base must be stepped to compensate. As the foundation steps up, ensure the minimum embedment is maintained. The height of each step is 185mm (7.25 in) – the height of one course. The 25mm (1 in) offset must be accounted for at each step.

Refer to “Stack the Units” on the following page for an illustration of stepping the base.

place filter cloth

Lay the approved filter fabric (geotextile) along the bottom of the rear 185mm (7.25 in) of the excavation and extend up the exposed cut face to the proposed wall height. Leave adequate material at the top to fold back towards the wall (completely containing the infill material). Stake the filter cloth against the slope during construction.

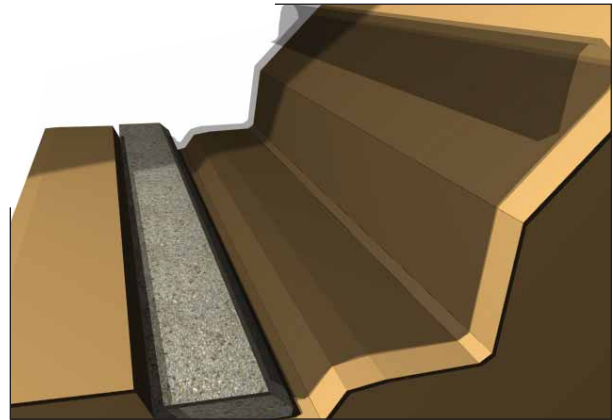

place the drain

Various options for drain placement may exist, depending on how the pipe is to be outlet (refer to *Details – Drainage*). The drain may be outlet through the wall face or connected to a positive outlet (storm drain). The drainage system is extremely important and outlets must be planned prior to construction.

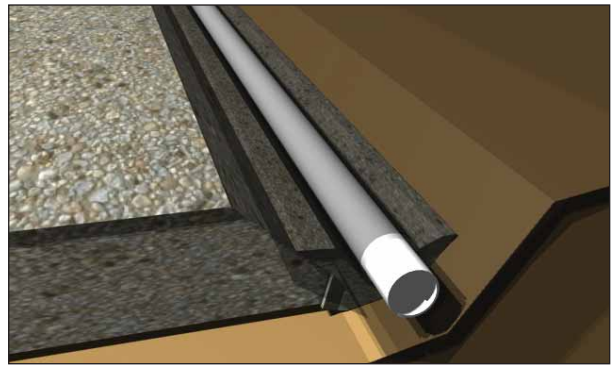

In the case of connecting to a positive outlet, the drain should be placed at the lowest possible elevation and sloped at a minimum of 2%. At the rear of the base, allow the granular material to slope down on the sides towards the drain trench. In the 185mm (7.25 in) area behind the base, place the approved drain tile (perforated drain with filter sock) on top of the filter cloth and minimal granular coverage.

place the first course

Position a level string to mark location of first course (should be 685mm [27 in] from the front edge of the granular base). Place the first course of SienaStone units side-by-side (touching) on the granular base. Ensure units are level front to back and left to right. Extra care should be taken at this stage as it is critical for accurate alignment.

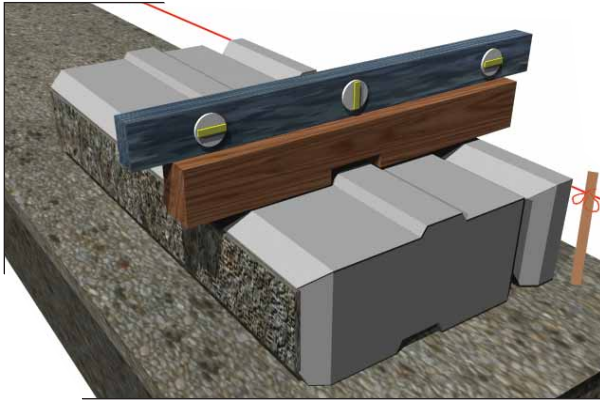

stack the units

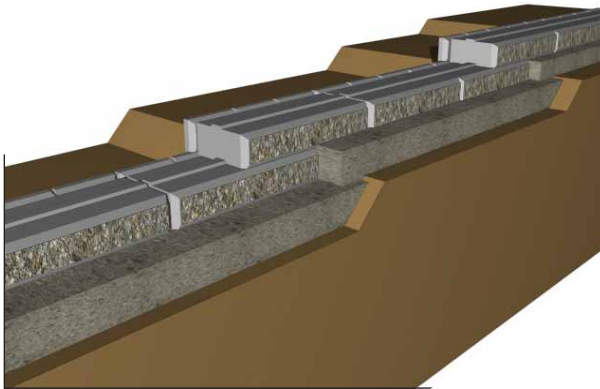

Sweep the top of the underlying course and stack the next course in a running bond pattern (so that the middle of the unit is above the joint between adjacent blocks below). Continue stacking courses up to the elevation of the first layer of geogrid or to a maximum of 3 courses (555mm [21.75 in]) before backfilling.

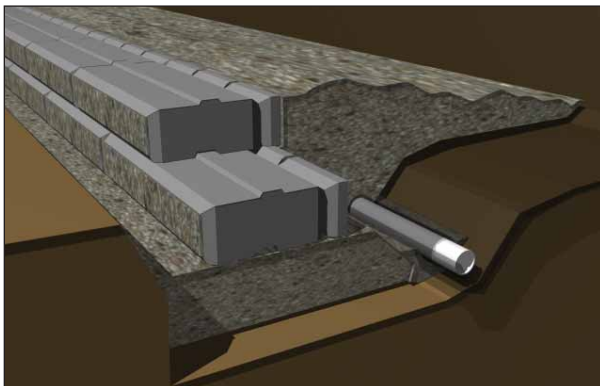

backfill

Begin backfilling the wall with a well-graded, free-draining (less than 8% fines), angular granular material. The infill material is placed in maximum

150mm–200mm (6 in–8 in) lift thickness and compacted to a minimum of 95% SPD. The compaction must be checked by the GRE at regular intervals. Continue backfilling up to the elevation of the first layer of geogrid reinforcement. Caution must be taken to ensure the allowable lift thickness is not exceeded and/or heavy compaction equipment is not operated within 1m of the back of the wall (only hand-operated plate compactor). Overcompaction behind the wall facing will result in an outward rotation of the units and poor vertical alignment.

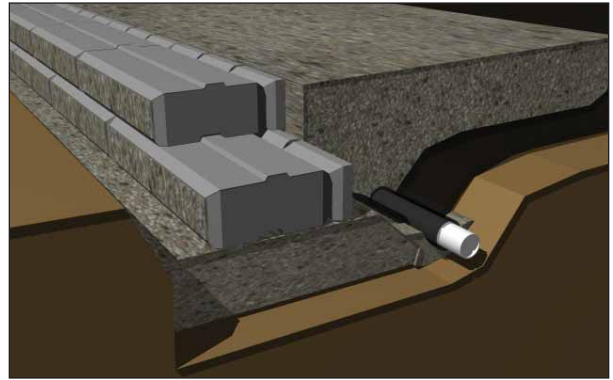

Note: Other backfill materials may be used if approved by the designer and GRE. (See Details–Using Alternate Backfill Materials)

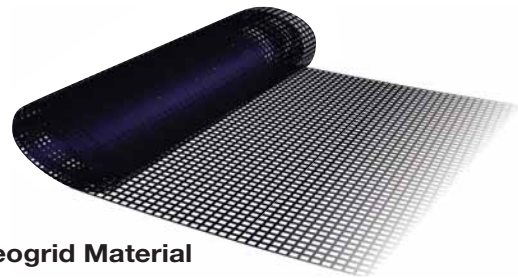

Geogrid Material

install geogrid reinforcement

Ensure the geogrid reinforcement specified in the design matches the product on site (no substitutes are acceptable without consent of design engineer). Cut the geogrid from the roll to the specified length, ensuring the geogrid is being cut perpendicular to the direction of primary strength. Ensuring the SienaStone units are free of debris, lay the geogrid on top of the blocks to within 25mm (1 in) of the face. Place the next course of SienaStone units (as described above) to secure the geogrid in place. Pull the geogrid reinforcement taut across the infill material to its full length and stake in place to maintain tension. The backfill material should be level with the back of the SienaStone unit, allowing the geogrid to be laid out horizontally.

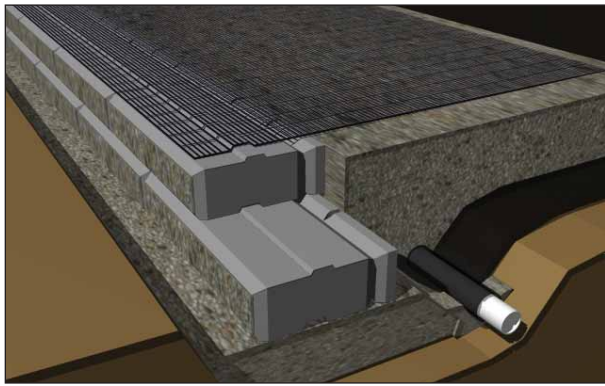

backfill over geogrid reinforcement

Backfill next lift of granular infill material on top of the geogrid reinforcement, placing the loose material at the back of the blocks, and raking it back, away from the face (this method maintains tension in the geogrid during backfilling). Continue stacking units and backfilling until the next layer of geogrid reinforcement is reached.

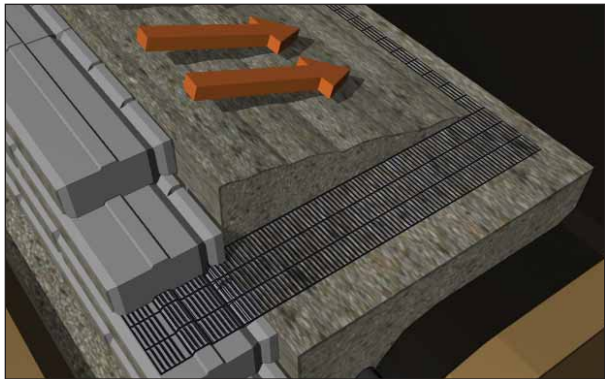

continue stacking and backfilling

Continue placing the SienaStone units, backfilling, and laying the geogrid reinforcement as described above until the desired wall height is reached.

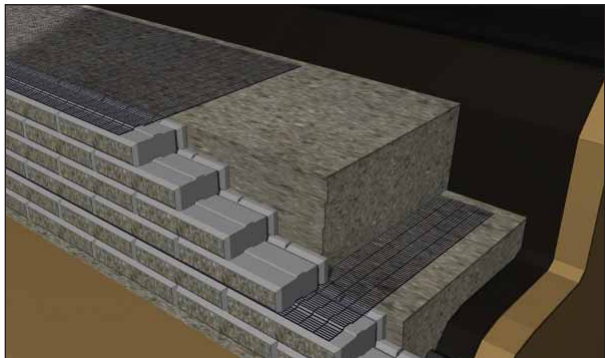

encapsulate the granular infill and finish grading

Fold the excess filter fabric over the top of the infill zone (reinforced zone) and extend up the back face of the coping unit. Ideally, place an impervious layer of soil on top of the filter fabric and compact manually, providing for the required grading and/or swales. For other treatments such as pavers, concrete, or asphalt, care must be taken to ensure that heavy compaction/paving equipment remains a minimum of 1.0m from the back of the coping unit. Slope the surface above and below the wall to ensure water will flow away from and not accumulate near the wall units.

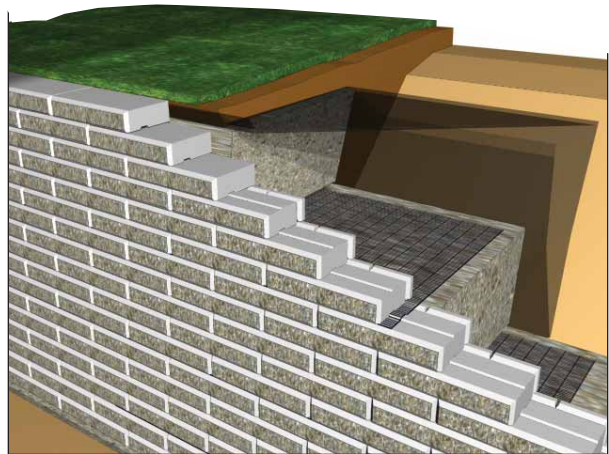



In the geogrid installation, we recommend using well-graded, free-draining (max. 8% fines) granular backfill material for the reinforced zone. This type of high quality material has several important benefits:

benefits of imported granular (free-draining) material

- Does not require tedious construction of drainage layer.
- Requires less monitoring by GRE.
- Compaction is less dependent on moisture content.
- Less susceptible to long-term creep of the soil mass.
- Higher shear capacity (greater strength) means less geogrid reinforcement.
- Better drainage and higher performance.

use of other approved materials

Other approved materials may be utilized for backfill, subject to minimum recommended parameters. We recommend that alternative backfill materials be limited to:

- Fine-grained soils with low plasticity (i.e. SC, ML, CL, with $PI \leq 20$)
- Material free of organics, debris, etc. that is approved by the CE as adequate for structural fill.

construction of required drainage layer when using non-free-draining materials

As these materials are not considered to be free-draining, a minimum 300mm (12 in) thick, 19mm (3/4 in) clear stone drainage layer must be placed immediately behind the wall with design-specified filter cloth to separate it from the reinforced soil.

At the geogrid layer elevations, the filter cloth must be cut and have minimum 150mm (6 in) overlap as shown in the drawing.

The reinforced soil must be compacted to 95% SPD or as specified in the design. At subsequent geogrid layers, the drainage layer must be completely

encapsulated as described above. As this is a critical component of the wall construction, care must be taken to ensure the drainage material is protected from contamination.

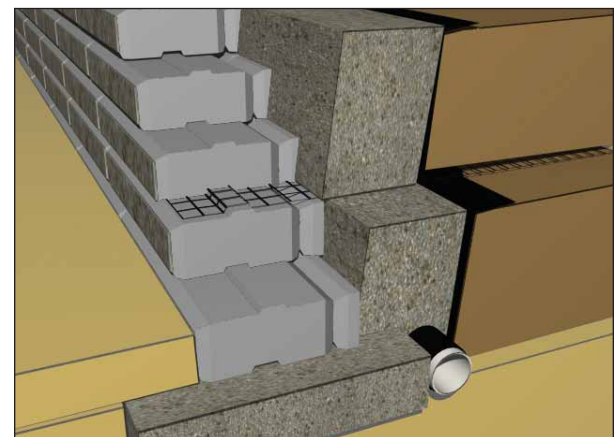
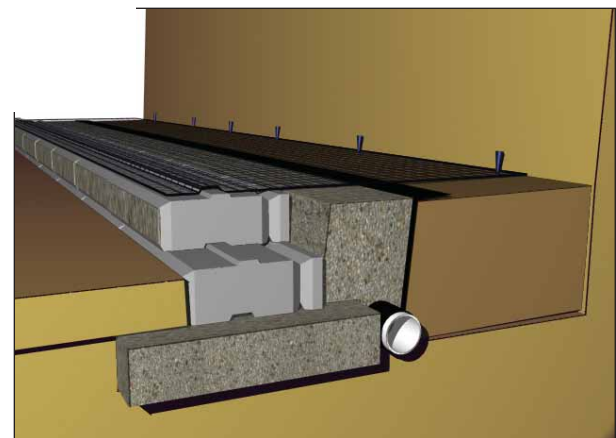
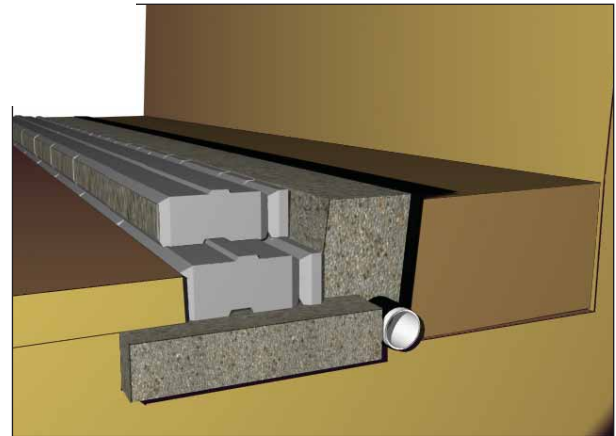



There are several key factors that should be considered when constructing a successful vertical wall.

- Ensure that you specifically order vertical units from the manufacturer.
- As SRWs are designed to “relax” forward to develop an Active Earth Pressure, it is very possible that a vertical wall could rotate forward past vertical, either during or after construction. To help accommodate this rotation, it is recommended that the base be constructed with a 3% negative slope from front to back (as shown).

500 units

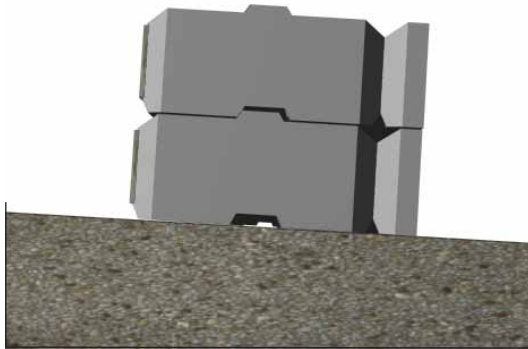

- The foundation material plays a substantial part in vertical walls. Any settlement in these types of walls could result in an over-vertical batter. Extra care must be taken to ensure the foundation bearing capacity is more than adequate, and that any anticipated settlement is taken into account.
- It is important to keep the compaction lifts of the backfill material to a minimum (150-200mm). Over-compaction of the material behind the units may result in a rotation forward.
- Heavy equipment (e.g. for compaction or paving) must be kept a minimum of 1m from the back of the wall.

925 units

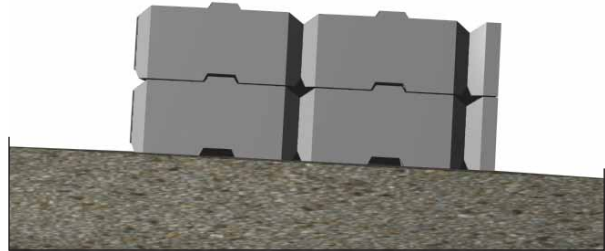

It is generally recommended that battered walls be constructed wherever possible. However, with proper preparation and care, vertical walls can be constructed successfully.

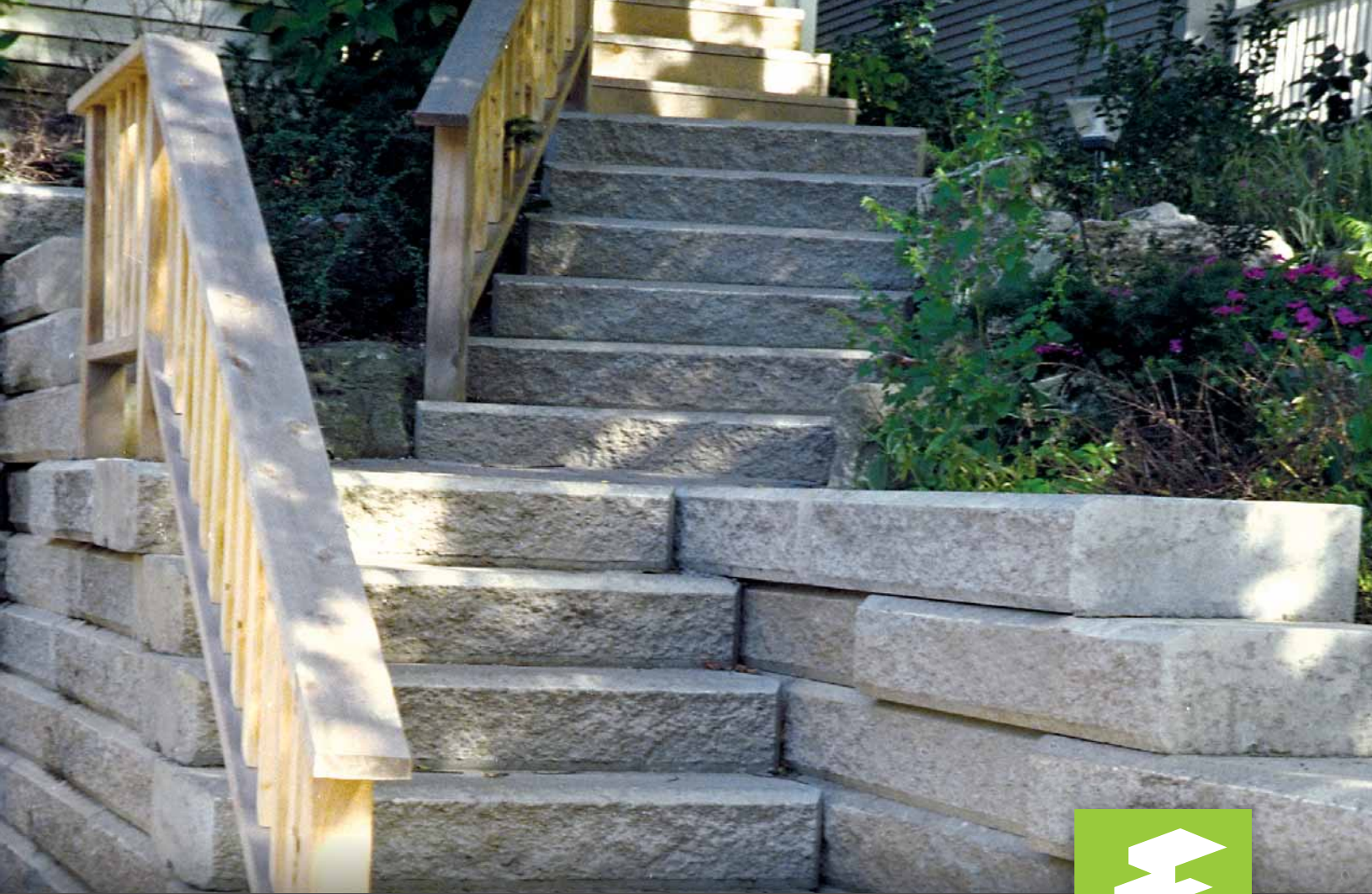

details

corners 500 units	22
corners 925 units	33
curves	35
fences and rails	36
drainage	38
obstructions	42
steps	43
terraces	45
finishing details	46



Outside 90° Corner

Place units on base course leading to the corner. Place corner unit (left corner shown) so both rough faces will be exposed in the final construction.

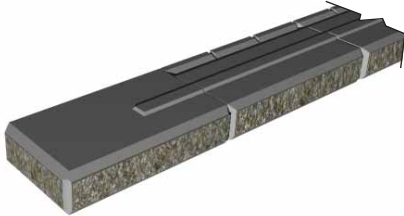

Continue placing base course units on adjacent wall, abutting the back side of the corner unit.

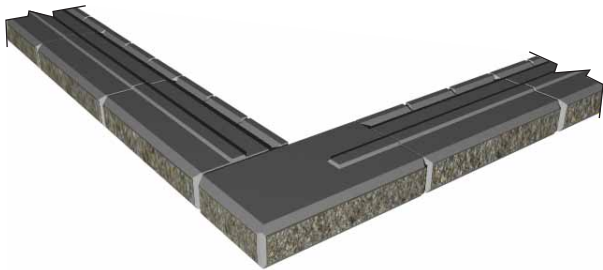

Commence second course by placing alternate corner unit (right corner shown) to interlock corner.

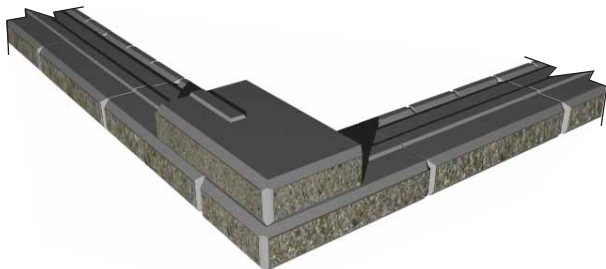

Place standard units to complete the course.

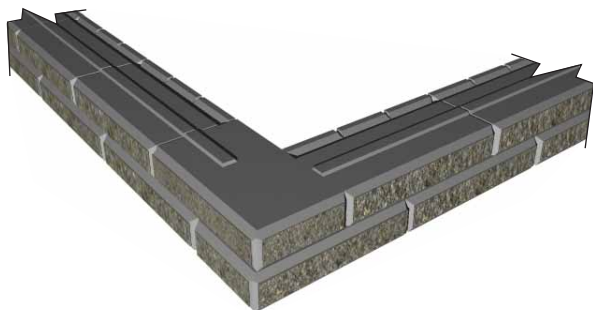

Repeat until desired wall height is achieved.

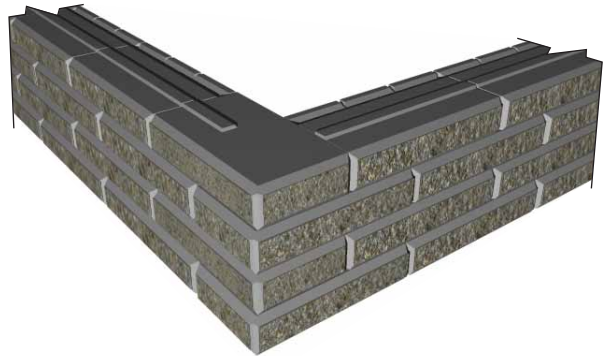

For reinforced applications, the geogrid from the two side walls will overlap and should be separated by a minimum of 75mm (3 in) of compacted soil. Alternatively, the geogrid reinforcement could be placed in the perpendicular principle direction in the cross-over area on the next course.

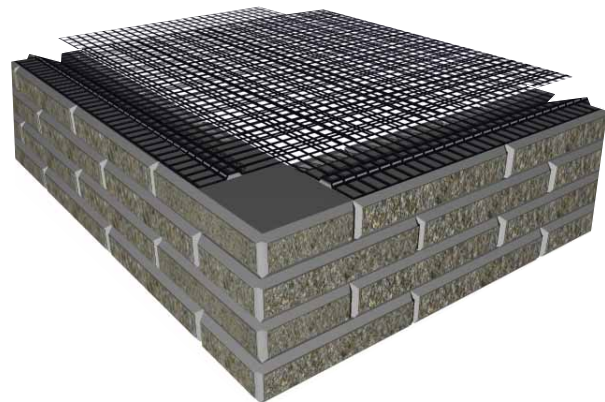

Place coping units as shown.

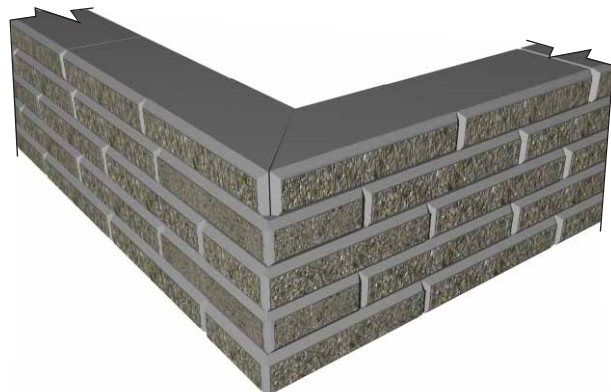

Inside 90° Corner

Place units on base course leading to the corner. Place corner unit so that the smaller rough face will be hidden in the final construction. It may be necessary to remove bumps and bulges from the larger rough face to achieve a tighter fit.

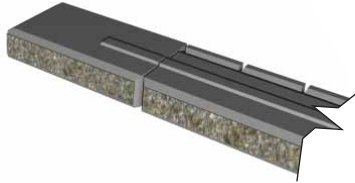

Continue placing base course units on adjacent wall.

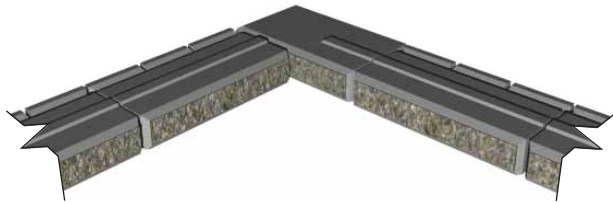

Commence second course by placing alternate corner unit to interlock corner.

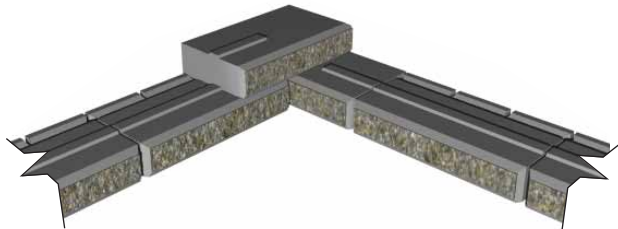

Place standard units to complete the course.

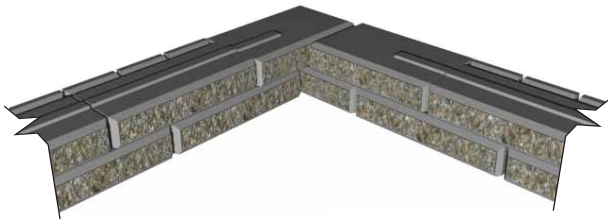

Repeat until desired wall height is achieved.

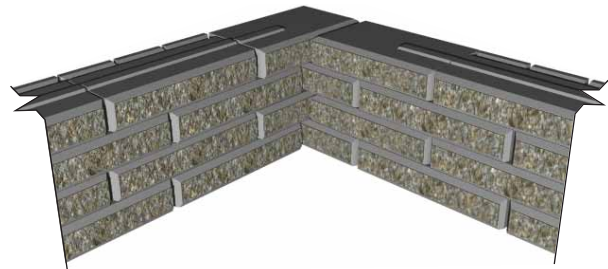

For reinforced applications, the geogrid should be placed within 25mm (1 in) of the face of the block. As it is only necessary to have geogrid extending directly away from the wall, a gap will result in the geogrid layer as shown.

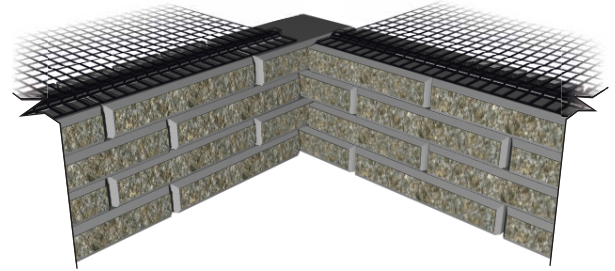

Place coping units as shown.

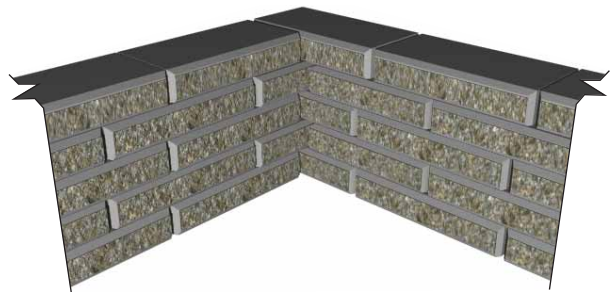

Outside 45° Corner

Place units on base course leading to the corner.
Place 45° corner unit (45° left corner shown) so both rough faces will be exposed in the final construction.



Continue placing base course units on adjacent wall.

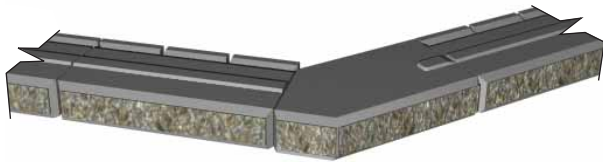

Commence second course by placing alternate 45° corner unit (45° right corner shown) to interlock corner.

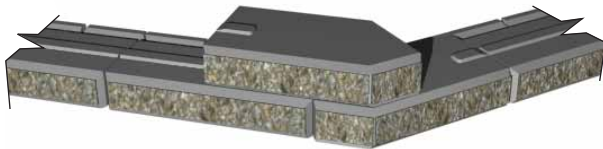

Place standard units to complete the course.

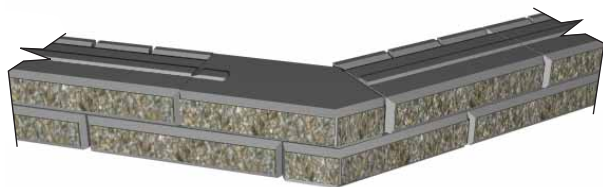

Repeat until desired wall height is achieved.

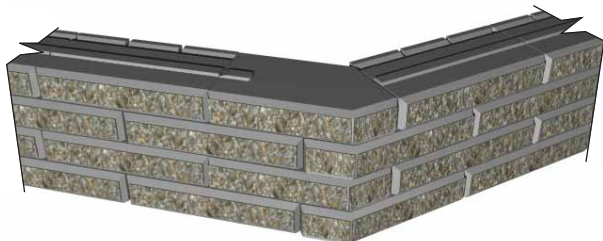

For reinforced applications, the geogrid from the two side walls will overlap and should be separated by a minimum of 75mm (3") of compacted soil. Alternatively, the geogrid reinforcement could be placed in the perpendicular principle direction in the cross-over area on the succeeding course.

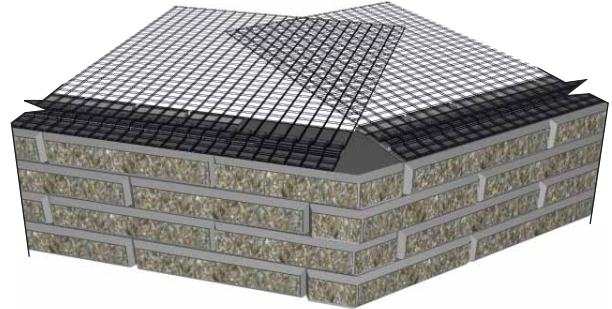

Place coping units as shown.

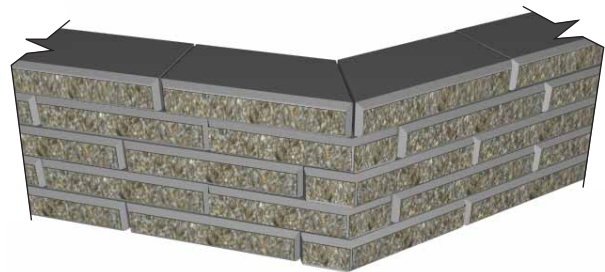

Odd-Angled Outside Corner

Place base course leading to the corner. Cut corner unit as required for the desired angle. It will be necessary to remove some of the shear key to allow for the next course.

Refer to "Making Modified Outside Corners, pages 29 - 31.

Note: A modified 45° unit is shown below. It is also possible to modify a 90° unit or a standard unit depending on the angle to be achieved.

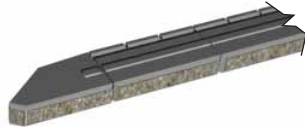

Continue placing base course on adjacent wall.



Place the modified corner unit on the next course to achieve an interlocked corner.



Place standard units to complete course.

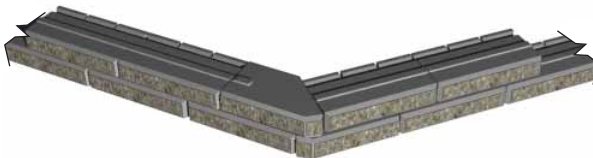

Repeat until desired height is achieved.

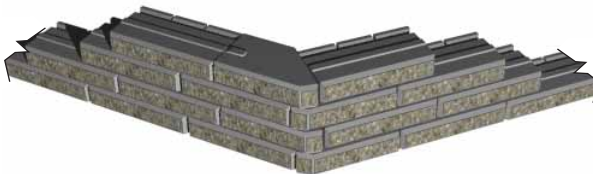

Place coping units to complete wall. Cut coping as required to produce a mitre corner.

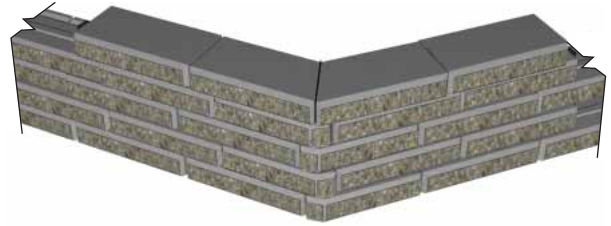

The geogrid from the two side walls will overlap and should be separated by a minimum of 75mm (3 in) of compacted soil. Alternatively, the geogrid reinforcement could be placed in the perpendicular principle direction in the crossover area on the succeeding course.

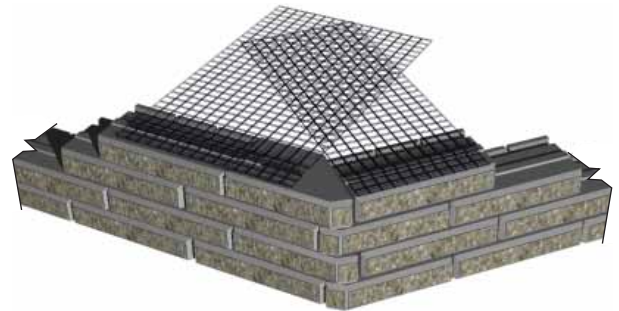

Making Modified Outside Corner Units

To construct corners for any angle, other than those created using the manufactured corner units, you will need to make modified the units as follows.

The tools you need to modify a unit include: tape measure, framing square, chalk, concrete saw, chisel and hammer.

Identify the necessary unit measurements from the table based on the angle of the corner. Decide if you are going to make a left or right modified corner unit. Select a unit identified in the "Unit to modify" column of the table. If you are using a 90° corner unit to start with, make sure you select the left or right corner unit that corresponds to the corner unit you are making. Use the appropriate diagram when measuring for your cut and split lines.

Measure the distances specified, on the front and back of the unit, and mark the SRW unit.

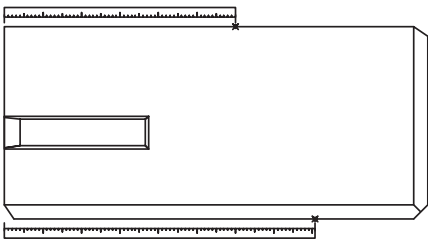

On one arm of the framing square mark the specified cut length. On the other arm mark the specified split length.

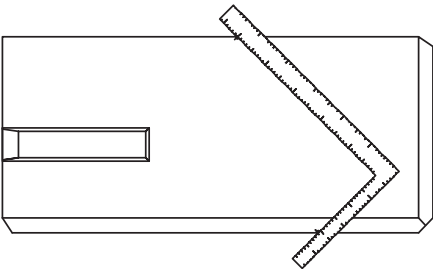

Align the marks on the framing square with the marks on the SRW unit. Trace the edge on the framing square to mark the unit. For outside corners, make sure the cut dimension is to the back of the SRW unit.

Saw cut the unit along the cut line to create a smooth square edge that will neatly abut the side of a standard unit.

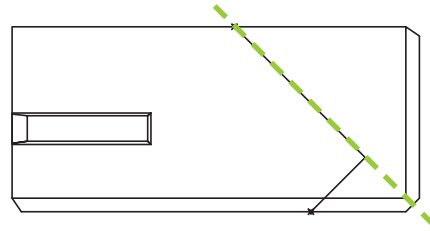

Score and split the unit along the split line to create the exposed face for the corner.

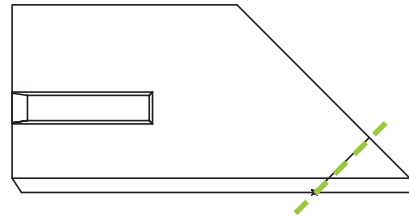

It will also be necessary to remove a portion of the key when using a 500 unit to allow the SRW unit from the next course to stack properly.

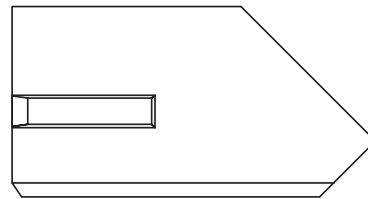

SienaStone 1.2m Modified Outside Corner – Metric Dimensions

Angle (degrees)	Unit to modify	Front (mm)	Back (mm)	Split (mm)	Cut (mm)
5	500 unit	622	600	22	500
10	500 unit	644	600	44	500
15	500 unit	666	600	66	500
20	500 unit	688	600	88	500
25	500 unit	711	600	111	500
30	500 unit	734	600	134	500
35	500 unit	758	600	158	500
40	500 unit	782	600	182	500
45 ¹	90° corner	807	600	207	500
50	90° corner	833	600	233	500
55	90° corner	860	600	260	500
60	90° corner	889	600	289	500
65	90° corner	919	600	319	500
70	90° corner	950	600	350	500
75	90° corner	984	600	384	500
80	90° corner	1020	600	420	500
85	90° corner	1058	600	458	500
90	Use manufactured 90° corner unit ²				
91-180	Not Recommended				

Outside Corner Unit Cut

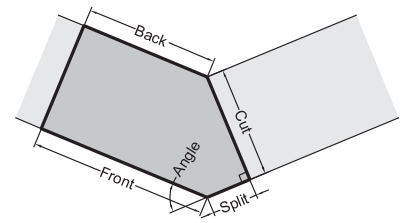

SienaStone 47 ¼" Modified Outside Corner – Imperial Dimensions

Angle (degrees)	Unit to modify	Front (inches)	Back (inches)	Split (inches)	Cut (inches)
5	500 unit	24 ½	23 ⅝	⅞	19 ⅝
10	500 unit	25 ⅜	23 ⅝	1 ¾	19 ⅝
15	500 unit	26 ¼	23 ⅝	2 ⅝	19 ⅝
20	500 unit	27 ⅛	23 ⅝	3 ½	19 ⅝
25	500 unit	28	23 ⅝	4 ⅝	19 ⅝
30	500 unit	28 ⅞	23 ⅝	5 ¼	19 ⅝
35	500 unit	29 ⅞	23 ⅝	6 ¼	19 ⅝
40	500 unit	30 ¾	23 ⅝	7 ⅛	19 ⅝
45 ¹	90° corner	31 ¾	23 ⅝	8 ⅛	19 ⅝
50	90° corner	32 ¾	23 ⅝	9 ⅛	19 ⅝
55	90° corner	33 ⅞	23 ⅝	10 ¼	19 ⅝
60	90° corner	35	23 ⅝	11 ⅜	19 ⅝
65	90° corner	36 ⅛	23 ⅝	12 ½	19 ⅝
70	90° corner	37 ⅜	23 ⅝	13 ¾	19 ⅝
75	90° corner	38 ¾	23 ⅝	15 ⅛	19 ⅝
80	90° corner	40 ⅛	23 ⅝	16 ½	19 ⅝
85	90° corner	41 ⅝	23 ⅝	18	19 ⅝
90	Use manufactured 90° corner unit ²				
91-180	Not Recommended				

• Imperial dimensions are nominal

¹ Some locations may manufacture 45 degree units

² The length of the 90° corner unit requires the running bond pattern to be corrected in adjacent units

SienaStone 1.0m Modified Outside Corner – Metric Dimensions

Angle (degrees)	Unit to modify	Front (mm)	Back (mm)	Split (mm)	Cut (mm)
5	500 unit	522	500	22	500
10	500 unit	544	500	44	500
15	500 unit	566	500	66	500
20	500 unit	588	500	88	500
25	500 unit	611	500	111	500
30	500 unit	634	500	134	500
35	500 unit	658	500	158	500
40	500 unit	682	500	182	500
45 ¹	90° corner	707	500	207	500
50	90° corner	733	500	233	500
55	90° corner	751	491	260	500
60	90° corner	756	467	289	500
65	90° corner	766	447	319	500
70	90° corner	781	431	350	500
75	90° corner	802	418	384	500
80	90° corner	828	408	420	500
85	90° corner	860	402	458	500
90	Use manufactured 90° corner unit ²				
91-180	Not Recommended				

Outside Corner Unit Cut

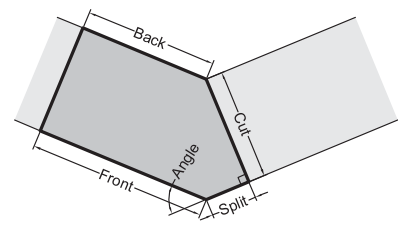

SienaStone 39 3/8" Modified Outside Corner – Imperial Dimensions

Angle (degrees)	Unit to modify	Front (inches)	Back (inches)	Split (inches)	Cut (inches)
5	500 unit	20 1/2	19 5/8	7/8	19 5/8
10	500 unit	21 3/8	19 5/8	1 3/4	19 5/8
15	500 unit	22 1/4	19 5/8	2 5/8	19 5/8
20	500 unit	23 1/8	19 5/8	3 1/2	19 5/8
25	500 unit	24	19 5/8	4 3/8	19 5/8
30	500 unit	25	19 5/8	5 1/4	19 5/8
35	500 unit	25 7/8	19 5/8	6 1/4	19 5/8
40	500 unit	26 7/8	19 5/8	7 1/8	19 5/8
45 ¹	90° corner	27 7/8	19 5/8	8 1/8	19 5/8
50	90° corner	28 7/8	19 5/8	9 1/8	19 5/8
55	90° corner	29 5/8	19 3/8	10 1/4	19 5/8
60	90° corner	29 3/4	18 3/8	11 3/8	19 5/8
65	90° corner	30 1/8	17 5/8	12 1/2	19 5/8
70	90° corner	30 3/4	17	13 3/4	19 5/8
75	90° corner	31 1/2	16 1/2	15 1/8	19 5/8
80	90° corner	32 5/8	16 1/8	16 1/2	19 5/8
85	90° corner	33 7/8	15 7/8	18	19 5/8
90	Use manufactured 90° corner unit ²				
91-180	Not Recommended				

• Imperial dimensions are nominal

¹ Some locations may manufacture 45 degree units

² The length of the 90° corner unit requires the running bond pattern to be corrected in adjacent units

Odd-Angled Inside Corner

Place base course leading to the corner. Cut corner unit as required for the desired angle

Refer to "Making Modified Inside Corner Units, page 30



Continue placing base course on adjacent wall. It will be necessary to remove some of the shear key to allow for the next course. The abutting unit is placed halfway along the side of the modified unit to maintain the running bond pattern.

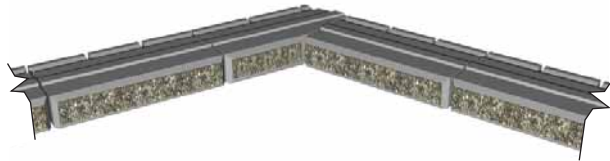

Place the modified corner unit on the next course to achieve an interlocked corner.

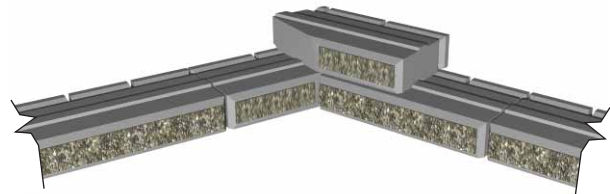

Place standard units to complete course. It may be necessary to run one of the standard units (halfway through the block as discussed above) into the infill material to maintain the running bond pattern.

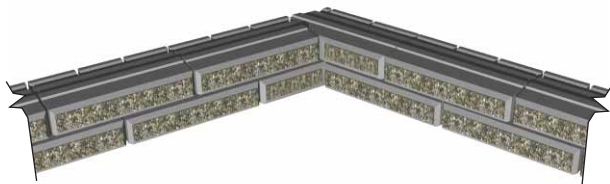

Repeat until desired height is achieved.

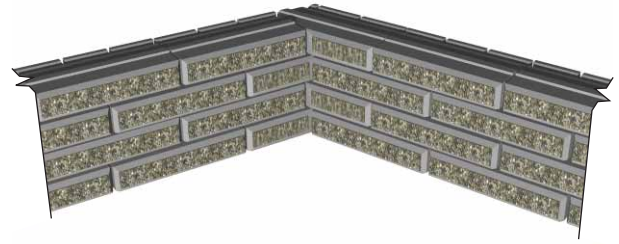

Place coping units to complete wall. Cut coping as required to produce a mitre corner.

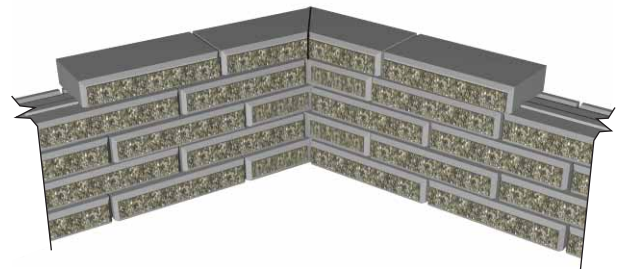

For reinforced applications, the geogrid should be placed 25mm (1 in) from the front face of the wall. A gap in the geogrid layer will result as shown.

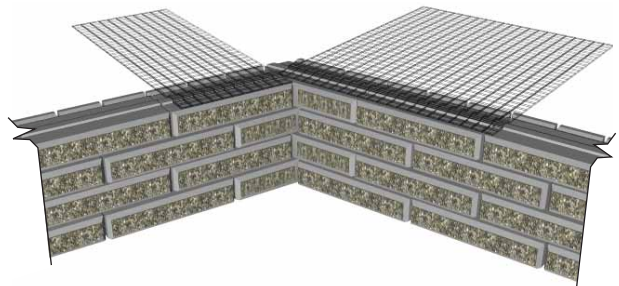

Making Modified Inside Corner Units

To construct corners for any angle, other than those created using the manufactured corner units, you will need to make modified corner units as follows.

The tools you need to modify a unit include: tape measure, framing square, chalk, concrete saw, chisel and hammer.

Identify the necessary unit measurements from the table based on the angle of the corner. Decide if you are going to make a left or right modified corner unit. Use the appropriate diagram when measuring for your cut and split lines.

Measure the distances specified, on the front and back of the unit, and mark the SRW unit.

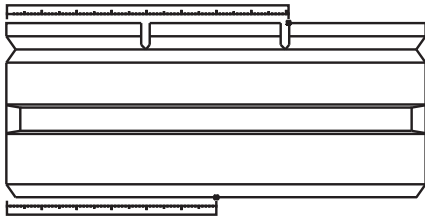

On one arm of the framing square mark the specified cut length. On the other arm mark the specified split length.

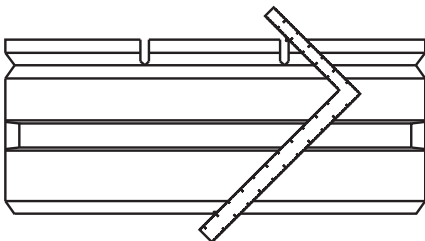

Align the marks on the framing square with the marks on the SRW unit. Trace the edge on the framing square to mark the unit. For inside corners, make sure the cut dimension is toward the front of the SRW unit.

Saw cut the unit along the cut line to create a smooth square edge that will neatly abut the side of a standard unit.

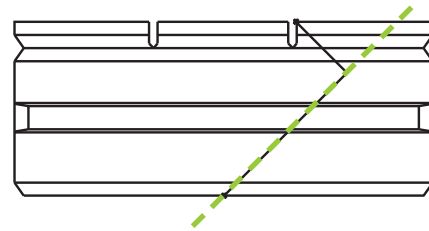

Score and split the unit along the split line to create the exposed face for the corner. For inside corners, it is not necessary to split the piece off since it will be buried behind the wall.

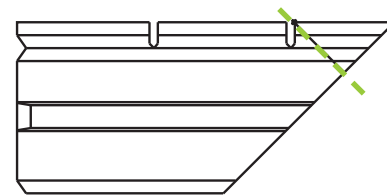

It will also be necessary to remove a portion of the key to allow the SRW unit from the next course to stack properly.

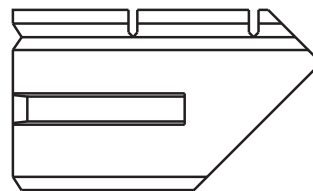

SienaStone 1.2m Modified Inside Corner – Metric Dimensions

Angle (degrees)	Unit to modify	Front (mm)	Back (mm)	Split ¹ (mm)	Cut (mm)
5	500 unit	600	622	22	500
10	500 unit	600	644	44	500
15	500 unit	600	666	66	500
20	500 unit	600	688	88	500
25	500 unit	600	711	111	500
30	500 unit	600	734	134	500
35	500 unit	600	758	158	500
40	500 unit	600	782	182	500
45	500 unit	600	807	207	500
50	500 unit	600	833	233	500
55	500 unit	600	860	260	500
60	500 unit	600	889	289	500
65	500 unit	600	919	319	500
70	500 unit	600	950	350	500
75	500 unit	600	984	384	500
80	500 unit	600	1020	420	500
85	500 unit	600	1058	458	500
90	Use manufactured 90° corner unit ²				
91-180	Not Recommended				

Inside Corner Unit Cut

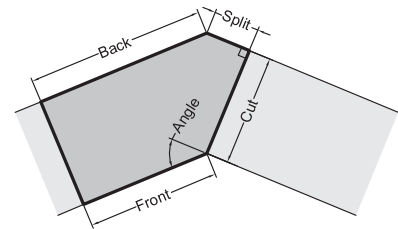

SienaStone 47 ¼" Modified Inside Corner – Imperial Dimensions

Angle (degrees)	Unit to modify	Front (inches)	Back (inches)	Split ¹ (inches)	Cut (inches)
5	500 unit	23 5/8	24 1/2	7/8	19 5/8
10	500 unit	23 5/8	25 3/8	1 3/4	19 5/8
15	500 unit	23 5/8	26 1/4	2 5/8	19 5/8
20	500 unit	23 5/8	27 1/8	3 1/2	19 5/8
25	500 unit	23 5/8	28	4 3/8	19 5/8
30	500 unit	23 5/8	28 7/8	5 1/4	19 5/8
35	500 unit	23 5/8	29 7/8	6 1/4	19 5/8
40	500 unit	23 5/8	30 3/4	7 1/8	19 5/8
45	500 unit	23 5/8	31 3/4	8 1/8	19 5/8
50	500 unit	23 5/8	32 3/4	9 1/8	19 5/8
55	500 unit	23 5/8	33 7/8	10 1/4	19 5/8
60	500 unit	23 5/8	35	11 3/8	19 5/8
65	500 unit	23 5/8	36 1/8	12 1/2	19 5/8
70	500 unit	23 5/8	37 3/8	13 3/4	19 5/8
75	500 unit	23 5/8	38 3/4	15 1/8	19 5/8
80	500 unit	23 5/8	40 1/8	16 1/2	19 5/8
85	500 unit	23 5/8	41 5/8	18	19 5/8
90	Use manufactured 90° corner unit ²				
91-180	Not Recommended				

• Imperial dimensions are nominal

¹ It is not necessary to split the back piece for inside corners since the edge will not be seen, this can be saw cut

² The length of the 90° corner unit requires the running bond pattern to be corrected in adjacent units

SienaStone 1.0m Modified Outside Corner – Metric Dimensions

Angle (degrees)	Unit to modify	Front (mm)	Back (mm)	Split (mm)	Cut (mm)
5	500 unit	500	522	22	500
10	500 unit	500	544	44	500
15	500 unit	500	566	66	500
20	500 unit	500	588	88	500
25	500 unit	500	611	111	500
30	500 unit	500	634	134	500
35	500 unit	500	658	158	500
40	500 unit	500	682	182	500
45 ¹	500 unit	500	707	207	500
50	500 unit	500	733	233	500
55	500 unit	500	760	260	500
60	500 unit	500	789	289	500
65	500 unit	500	819	319	500
70	500 unit	500	850	350	500
75	500 unit	500	884	384	500
80	500 unit	500	920	420	500
85	500 unit	500	958	458	500
90	Use manufactured 90° corner unit ²				
91-180	Not Recommended				

Inside Corner Unit Cut

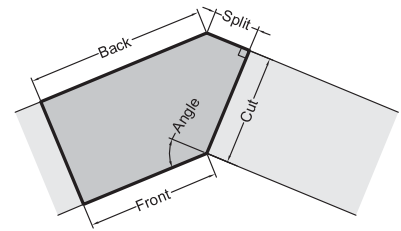

SienaStone 39 3/8" Modified Outside Corner – Imperial Dimensions

Angle (degrees)	Unit to modify	Front (inches)	Back (inches)	Split (inches)	Cut (inches)
5	500 unit	19 5/8	20 1/2	7/8	19 5/8
10	500 unit	19 5/8	21 3/8	1 3/4	19 5/8
15	500 unit	19 5/8	22 1/4	2 5/8	19 5/8
20	500 unit	19 5/8	23 1/8	3 1/2	19 5/8
25	500 unit	19 5/8	24	4 3/8	19 5/8
30	500 unit	19 5/8	25	5 1/4	19 5/8
35	500 unit	19 5/8	25 7/8	6 1/4	19 5/8
40	500 unit	19 5/8	26 7/8	7 1/8	19 5/8
45 ¹	500 unit	19 5/8	27 7/8	8 1/8	19 5/8
50	500 unit	19 5/8	28 7/8	9 1/8	19 5/8
55	500 unit	19 5/8	29 7/8	10 1/4	19 5/8
60	500 unit	19 5/8	31	11 3/8	19 5/8
65	500 unit	19 5/8	32 1/4	12 1/2	19 5/8
70	500 unit	19 5/8	33 1/2	13 3/4	19 5/8
75	500 unit	19 5/8	34 3/4	15 1/8	19 5/8
80	500 unit	19 5/8	36 1/4	16 1/2	19 5/8
85	500 unit	19 5/8	37 3/4	18	19 5/8
90	Use manufactured 90° corner unit ²				
91-180	Not Recommended				

• Imperial dimensions are nominal

¹ Some locations may manufacture 45 degree units

² The length of the 90° corner unit requires the running bond pattern to be corrected in adjacent units

925 unit

Note: Once the recommended number of 925 units are placed (refer to site-specific design), the remaining courses can be installed with the standard 500 units. Refer to Details–Corners–500 Unit–90° Outside Corner for construction.

90° Outside Corner

Place units on base course leading to the corner. Place standard 500 corner unit (left corner shown) so both rough faces will be exposed in the final construction.

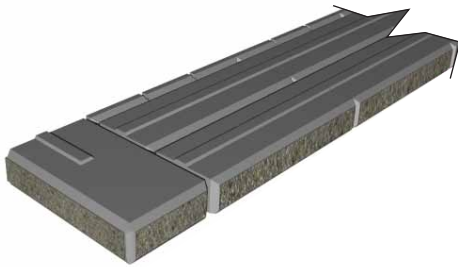

Continue placing base course units on adjacent wall. For 900 mm wide corner units, cut rear 25 mm (1 in) off back of adjacent 925 unit to ensure depth is equal.

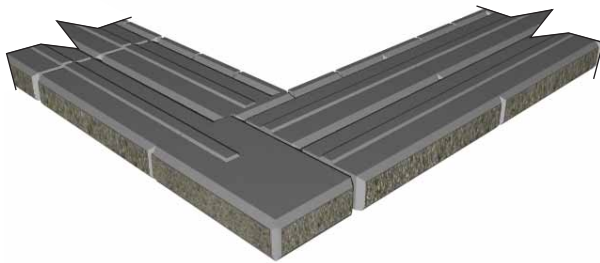

Commence second course by placing alternate standard 500 corner unit (right corner shown) to interlock corner.

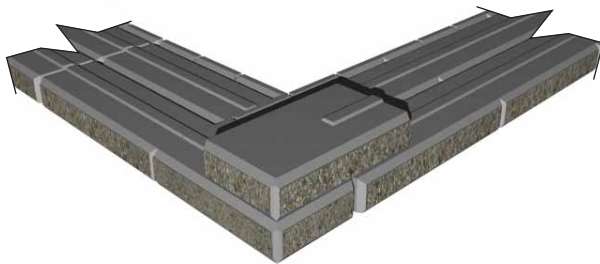

Place standard units to complete the course.

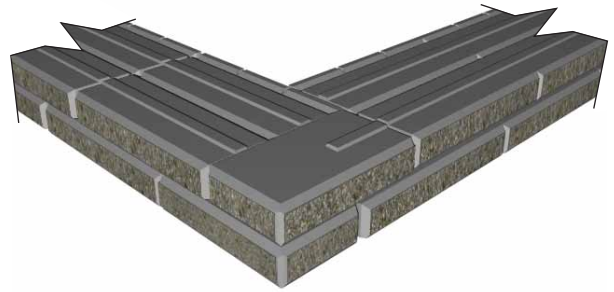

Repeat until desired wall height is achieved.

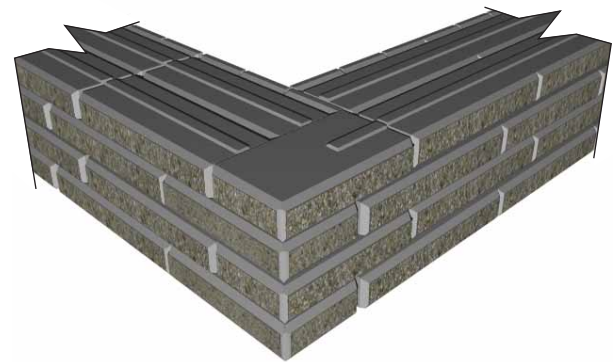

90° Inside Corner

Place units on base course leading to the corner. It will be necessary to remove the shear key to allow for the next course. It may be necessary to remove bumps and bulges from the larger rough face to achieve a tighter fit.

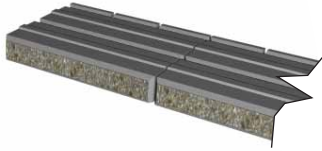

Continue placing base course units on adjacent wall. A half-unit overlap will be required as shown to maintain the running bond pattern.

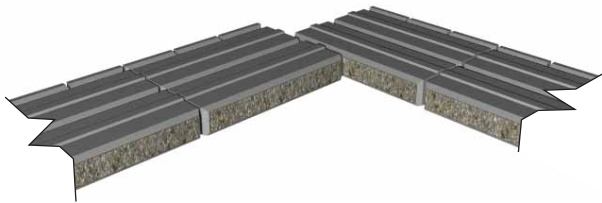

Overlap 925 unit into adjacent wall by half a unit to maintain running bond pattern. The shear key will need to be removed.

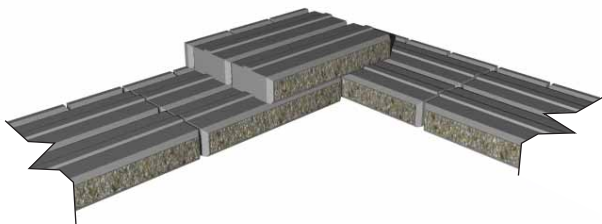

Continue placing 925 units to complete course.

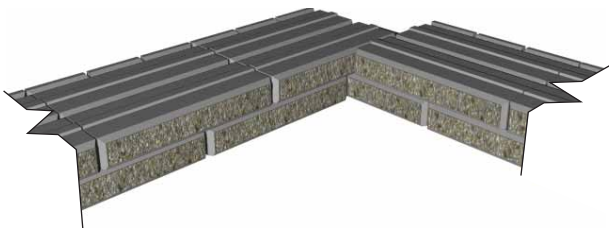

45° Outside Corner

Place units on base course leading to the corner. Place standard 500 45° corner unit so both rough faces will be exposed in the final construction.

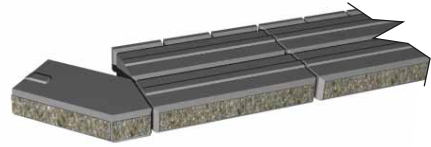

Continue placing base course units on adjacent wall.

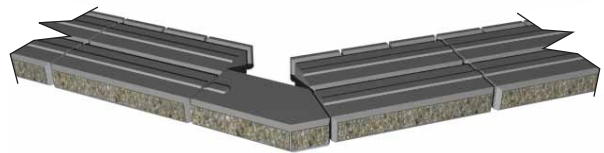

Commence second course by placing alternate standard 500 45° corner unit (right corner shown) to interlock corner.



Place standard units to complete the course and repeat until desired wall height is achieved.

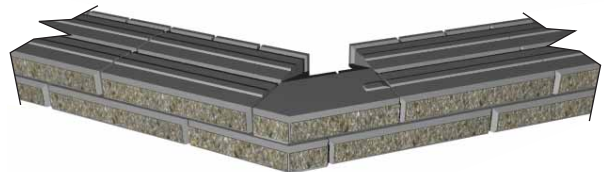

Odd-Angled Corners

Refer to pages 26 - 28 Making Modified Outside Corner Units

Refer to pages 30 - 32 Making Modified Inside Corner Units



concave

500 Units

The minimum inside radius using the standard units is 73m (240ft), so the concave curve is quite nominal. The radius can be achieved by separating the adjacent units at back face based on the radius required on site.



Repeat the previous step, making sure the groove and tongue can fit at each course.

Half Tapered Units

The minimum inside radius using the half tapered units is 3.6m (12ft).



convex

500 Units

The minimum outside radius using the standard units is 73m (240ft), so the convex curve is also quite nominal. The radius can be achieved by separating the adjacent units at front face based on the radius required on site.



Repeat the previous step, making sure the groove and tongue can fit at each course.

Half Tapered Units

The minimum inside radius using the half tapered units is 3.6m (12ft).

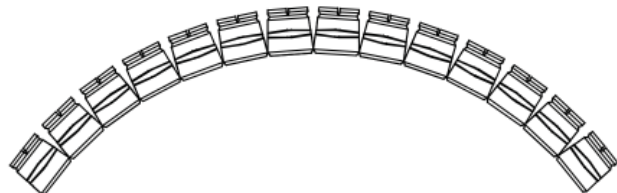



wood fences

Wood fences/acoustical fences may be constructed behind a SienaStone wall. These types of fences can pick up significant wind loads. The retaining wall must be designed to account for this additional loading and the fence typically can not be secured to the SienaStone retaining wall.

Concrete sonotubes, placed behind the wall, should be utilized to found the handrail/fence into the reinforced soil zone.

Loads created by pedestrians and/or wind on the fences must be incorporated into the geogrid design. As the sonotube depth increases, the additional lateral force generated in each geogrid is reduced. Wood/vinyl fences (solid) that take a wind load produce extremely high loads. Generally, foundations for these types of structures should extend more than the height of the fence into the reinforced soil, and the geogrid layout designed accordingly.

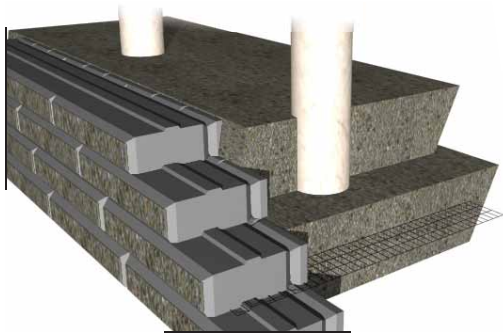

Construct the geogrid reinforced SienaStone SRW up to the elevation corresponding to the underside of the fence foundation (concrete sonotube).

Identify the proposed location of the solid fence foundations (sonotubes). Take into account the batter (setback) of the wall (25mm (1 in) per course) and the required offset at the top (It is preferable to leave a 300mm (12 in) buffer zone between the outside of the sonotube and the back of the wall. If this is not possible, expansion joint material must be placed between the back of the coping unit and concrete sonotube). Place the sonotube and backfill around it to hold it in place. Continue stacking units, backfilling and compacting to 95% SPD until the next geogrid layer is reached.

Cut the geogrid perpendicular to the wall along the centerline of the sonotube, creating two geogrid panels – one on each side of the sonotube. Lay the geogrid flat in front of the sonotube. Secure the geogrid in place at the wall with the next course of units. At the intersection with the sonotube, fold the geogrid flat against vertical side of the sonotube and then around the back, maintaining the edge of the geogrid along the centerline of the sonotube. Lay the geogrid flat behind the sonotube and pull taut. Secure the geogrid at the rear (with stakes) and continue backfilling.

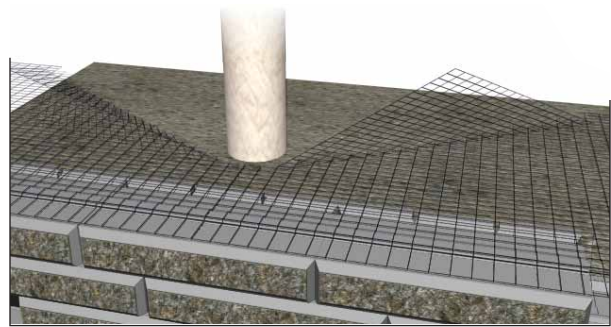

Repeat the previous step for each layer of geogrid encountered by the sonotube.

Secure the coping unit and fold filter cloth back over drainage material. Cut filter cloth at centerline of sonotube to allow the sonotube through (similarly to method used to allow sonotube to penetrate geogrid layer), ensuring complete coverage of reinforced material. Cover sonotubes prior to concrete pour to prevent debris from entering.

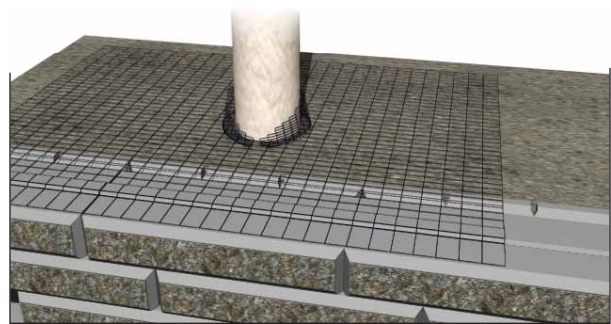

Pour concrete in foundations in accordance with fence design (reinforcing steel and/or dowels may be required). Install fence and finish grading.

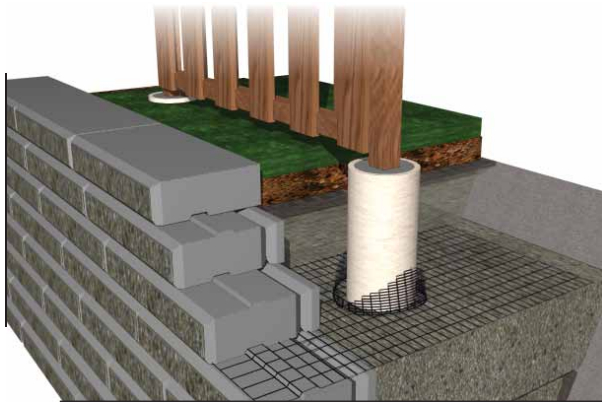
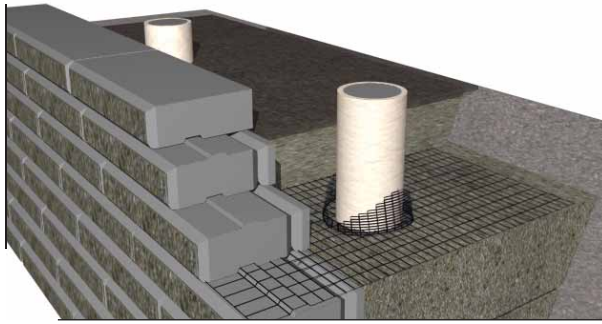

guardrails

For areas adjacent to roadways and parking lots, flexible steel beam guiderails may be placed behind a geogrid reinforced SienaStone SRW in accordance with the applicable governing standards. Additional “crash” loads must be accounted for in the design of the wall. Accepted procedures usually require the guiderail posts to be offset a minimum of 1m (3ft) from the front face of the wall, extending a minimum of 1.5m (5ft) into the reinforced zone.

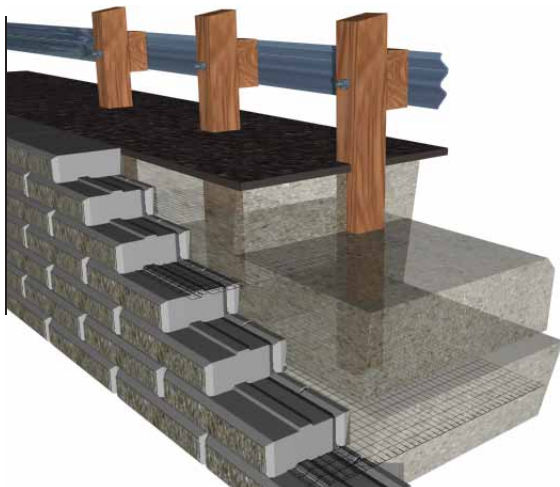

It is recommended that the posts be placed as the wall is constructed (refer to handrail construction) and compaction surrounding the posts be carefully monitored to ensure optimum confinement.

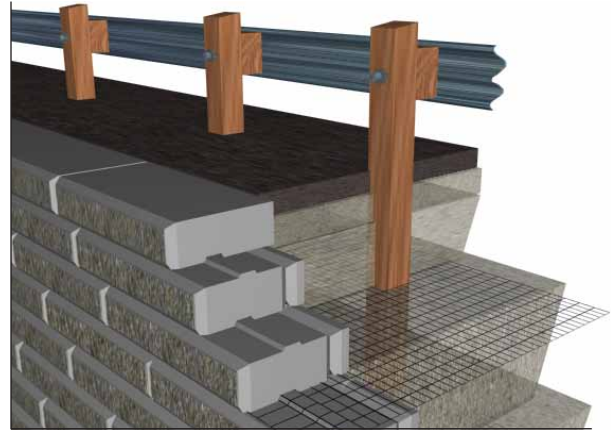

pedestrian handrail / chainlink fence

Chainlink fences and pedestrian handrails (not wind bearing) may be attached directly to the SienaStone wall. In order to resist the required loads, the post (maximum diameter 100mm [4 in]) must be core-drilled a minimum of 650mm (25 in), and be secured with **non-expansive grout**. (Non-shrink grout: follow manufacturer’s recommended installation procedures. Use of expansive grout will cause failure of the units.)

The holes are to be drilled a minimum of 200mm (8 in) from the front face of the wall with a maximum post separation of 2430mm (96 in).

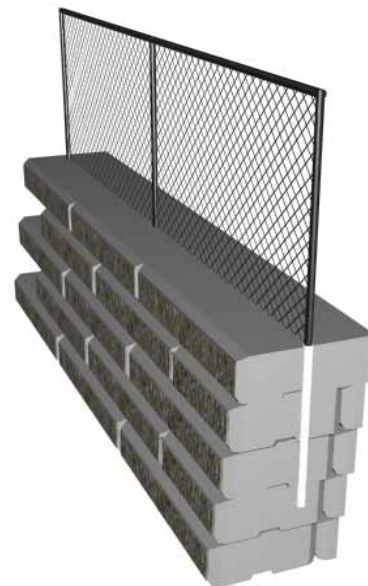



Proper drainage of a segmental retaining wall is one of the most critical aspects of design and construction. Unless otherwise stated, the design assumes that no hydrostatic pressures exist behind the wall. To ensure this condition is met, water flow from all directions and sources must be accounted for in the design through proper grading and drainage measures, diverting water away from the wall whenever possible.

internal drainage

This chart explains and illustrates the four different internal drainage possibilities.

Non-Free-Draining Reinforced Zone

If the infill material being used to construct the reinforced zone is not considered to be free draining (>8% fines), a drainage layer is required immediately behind the face of the wall. The drainage material must be a minimum of 300mm (12 in) thick, composed of a gap-graded, free-draining, angular clear stone (19mm [$\frac{3}{4}$ in]). An approved filter cloth must be placed between the drainage layer and the infill material to prevent the migration of fines and contamination of the drainage material. At each geogrid layer, the filter cloth must be pulled back into the reinforced zone a minimum of 150mm (6 in) and cut. The drainage layer must be fully encapsulated with a 150mm (6 in) overlap at each geogrid elevation as shown.

Free-Draining Reinforced Zone

As the construction of a separate drainage layer immediately behind the facing units can be cumbersome and reduce efficiency, a popular option is to use a free-draining, granular material for the reinforced zone. It is recommended that this material be well-graded, with less than 8% fines. An approved filter cloth should be placed between the reinforced zone and retained and foundation soil to prevent the migration of fines. The use of an imported granular material in the reinforced zone has many other advantages besides its good drainage properties (see *Specifications – Soils*).

Outlet to Catch basin / Drain

If the drain is being connected to a catch basin or other positive outlet, it should be located at the lowest elevation possible. Placing the drain at the founding elevation ensures better drainage of the base and subsoils. A minimum 2% slope is recommended.

Outlet Through Face

If the drain is being outlet through the face of the wall, it is recommended that an approved, less pervious engineered fill material be compacted under the drain up to the grade in front of the wall. This measure collects water percolating through the reinforced zone and directs it to the drain, rather than allowing the base to become saturated. The outlet pipe should be a non-perforated PVC (connected through a T-joint) placed a minimum of 15.0m (45 ft) on centre (or as required by the design). The SienaStone unit is shifted over as required to allow the pipe to be outlet. It is recommended that the area around the pipe be grouted to prevent the washout of fine soil particles. A concrete splash pad at the outlet pipe locations is recommended if large water flows are anticipated.

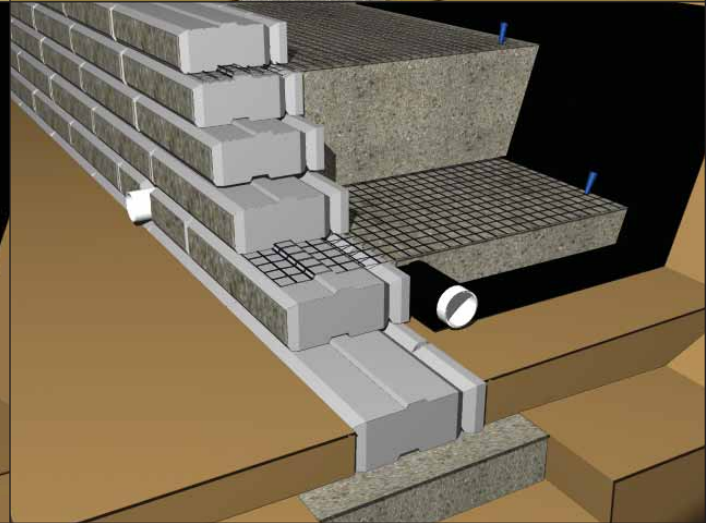
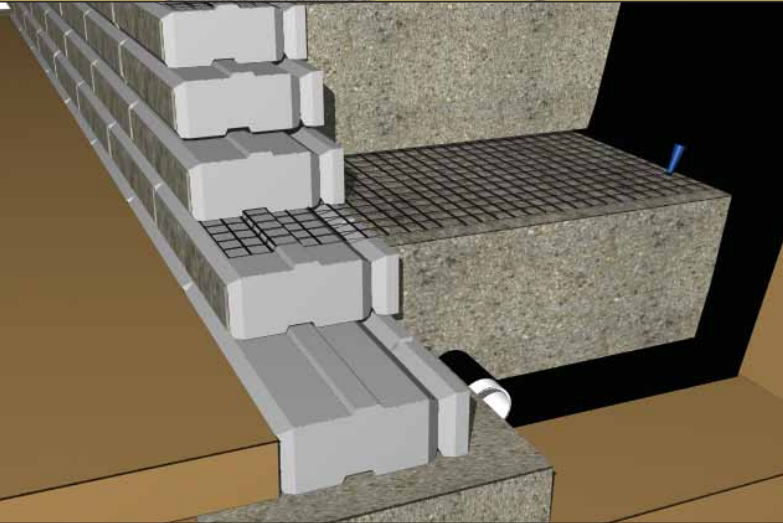
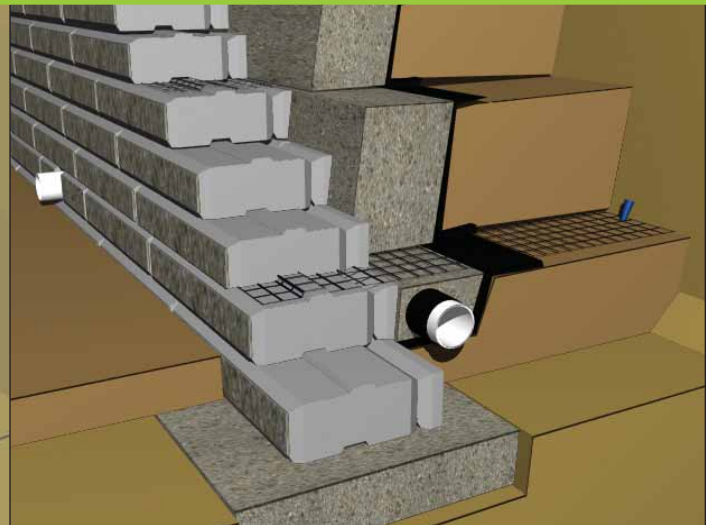
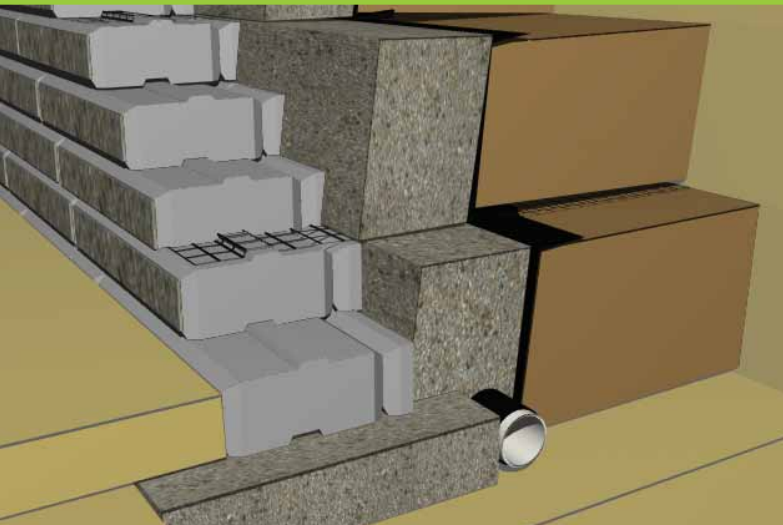

external drainage

Swales

Surface water run-off should be diverted away from the retaining wall to help prevent the build up of hydrostatic pressures behind the wall. This can be achieved by providing a swale with a minimum gradient along the length of the wall of 2%.

Clay Swale

A 100mm (4 in) top soil layer may be underlined with a 100mm (4 in) low permeability clay soil to divert the surface run-off. The top soil layer is to support the growth of vegetation that provides erosion protection for both the top soil and clay layers. The slope directly away from the wall helps to ensure that water is not given a direct route into the drainage material if settlement occurs. A filter fabric should be placed between the clay layer and infill material to prevent the migration of fines.

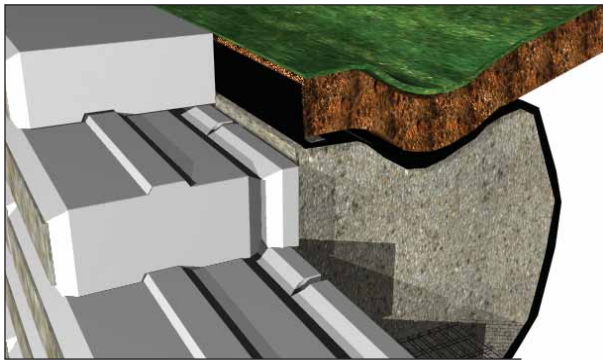

Concrete Swale

A 100mm (4 in) concrete or asphalt swale may be used to divert surface runoff. A 25mm expansion joint should be placed between the concrete and the back of the retaining wall. Heavy paving equipment should be kept a minimum of 1m away from the wall to prevent movement of the top courses.

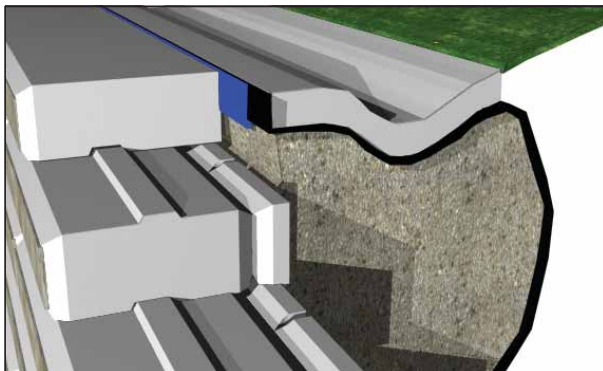

Blanket / Chimney Drains

Where high groundwater flows are anticipated, the use of blanket drains (drainage layer extended horizontally along the base of the wall) or chimney drains (drainage layer extended up the back of the infill zone to intercept groundwater flows) prevent infiltration in the SienaStone structure. A drainage composite material can be very effective when used to construct a chimney drain.

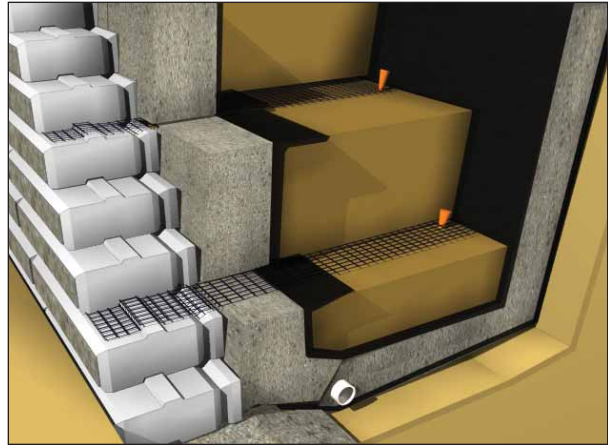

water applications

SienaStone geogrid reinforced segmental retaining walls may be used in water applications such as lake/river shorelines, detention ponds, etc. A number of additional issues must be considered when designing and constructing in this type of application, such as erosion of the base/foundation, wave effects, perched water conditions, ice effects, etc.

The SienaStone wall analysis must incorporate the effects of buoyant unit weights, rapid draw-down conditions, etc, when determining geogrid length, type, and placement. The required wall embedment normally increases as the potential for erosion becomes a factor. A minimum 600mm (2.0 ft) embedment is standard practice. As well, rip-rap or other forms of erosion protection may be required.

The footing may be concrete or standard granular wrapped in filter cloth to prevent washout. If the potential for rapid draw-down (water level falling quicker in front of the wall than the backfill material will allow) exists, the infill material must be chosen to reduce the effects. It is recommended that a clear-stone drainage layer be used in conjunction with a well-graded, free-draining, granular reinforced zone. The filter cloth used between the drainage layer and reinforced zone should be selected taking into account the two types of granular materials.

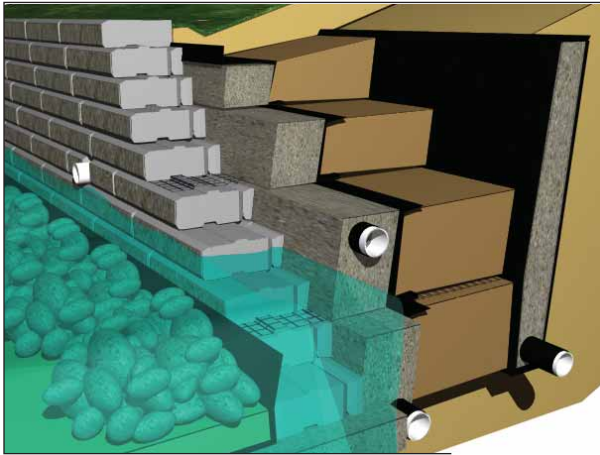

The placement of drains is based on the anticipated normal and high water levels. An outlet through the wall face should be placed above the normal and high water levels at minimum 15m (45ft) on centre. If the groundwater level is expected to fall below the foundation elevation, an additional drain should be added at this level. As well, a chimney or blanket drain may also be required depending on conditions.

If ice or wave effects are anticipated, rip-rap protection must be designed accordingly.

box culverts and headwalls

The key point in building this type of wall is to structurally separate the SienaStone wall from the concrete headwall. Essentially, the SienaStone wall must be constructed as three separate structures, allowing any potential differential settlement to occur without distress in the face. The walls must be abutted tightly with a 25mm (1 in) expansion joint separating them and the headwall.

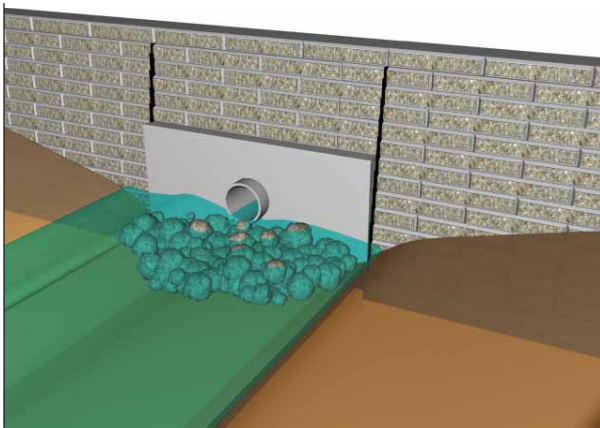

The picture shows the bottom of SienaStone units resting on top of the headwall. However, this may

not actually happen on site. A layer of mortar may have to be used to raise the elevation of the headwall to ensure that the courses line up on the adjacent sections of wall.

As the diameter of the culvert increases it may be easier to construct a head wall at the end of the culvert and assemble the wall using the box culvert details.

round culvert through wall

A culvert may be outlet through the face of the wall, providing the pipe has been designed to withstand the load of the wall above it and no excessive settlement is anticipated which may alter the alignment of the pipe. Once these issues have been addressed, the SienaStone units can be cut to fit on site. A 25mm asphalt-impregnated fibre board expansion joint should be placed around the pipe to ensure a tight fit and prevent the infill material from washing out. Rip-Rap is also required to protect the base from washout.

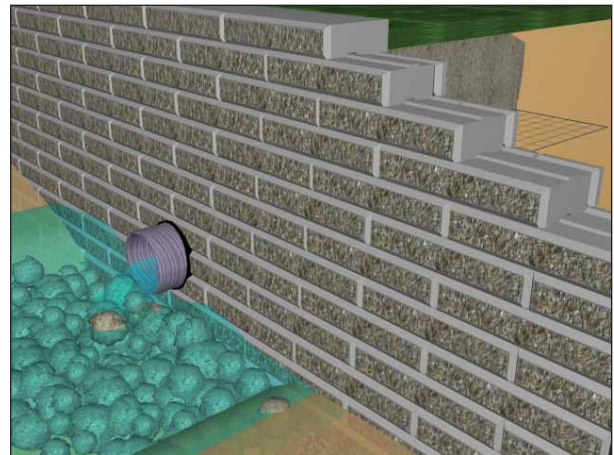



catch basin

When a catch basin is interfering with the placement of the geogrid reinforcement as specified by the site design, the following steps can be taken. Select an appropriately sized steel pipe with a length of at least twice the width of the catch basin. This pipe will be used to tie back the section of wall adjacent to the catchbasin. Start by constructing the wall up to the elevation of the first layer of geogrid.

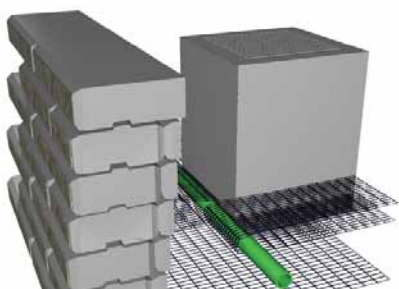

Area Adjacent to Catchbasin:

1. Cut a layer of geogrid to a length equal to twice the depth from the front face of the wall to the catchbasin plus 200mm (8 in).
2. Lay the geogrid on the specified course and secure it in place by placing the next course.
3. Pull the geogrid back towards the catchbasin. Lay the steel pipe on top of the geogrid and pull the remaining length of geogrid up away from the pipe.
4. Backfill to the top of this course and pull the remaining geogrid back over the infill zone towards the wall. Lay the geogrid flat on top of the most recently placed course and secure in place with next course.

Area on Either Side of Catchbasin: Instead of tying the facing to the pipe (as in previous section), tie the pipe back into the infill zone as described above, ensuring a minimum of 150mm (6 in) of compacted infill material between the top and bottom layer of geogrid.

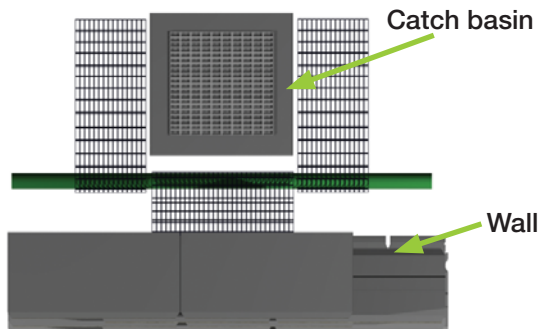

structures

Retaining walls constructed near structures must be placed outside the zone of influence of the footing as required by the Geotechnical Engineer (typically a 7V:10H influence line). If there is a space limitation, it may be necessary to underpin the foundation of the structure.



trees

When planting trees or shrubs behind SienaStone walls, a few steps must be taken to ensure the stability of the wall. The root ball should only impact the top two layers of the geogrid reinforcement. The geogrid should be cut perpendicular to the wall along the centerline of the root ball, placed flat and at the intersection with the root ball folded up the sides around to the back, maintaining the edge of the geogrid along the centerline of the root ball. Small trees (max. 0.915m [3 ft]) may be placed a minimum of a 1.5m [5 ft] from the face of the wall. Larger trees (max. 1.8m [6 ft]) are to be placed a minimum of 3m [10 ft] from the face of the wall. These distances are required to avoid root growth into the SienaStone blocks and to reduce the wind loading effects caused by the trees. If multiple trees are to be planted, a qualified Engineer should be contacted to assess the impact of the geogrid cuts. A root barrier may also be required to avoid root growth towards the SienaStone wall and drainage layer structures.





inset

Start with two outside 90° outside corner sidewalls. The walls are separated by the required step width. The side walls can be built in either battered or vertical arrangement, as specified in the design. If side walls are battered, the step width (base extended to constant elevation) must be adjusted to meet wider distances between the side walls as each course steps back. The side walls can be constructed on a level foundation elevation as shown in the drawing or stepped up to follow the grade change created by the steps. If the side walls are stepped up, make sure a minimum one course of units of side walls are embedded.

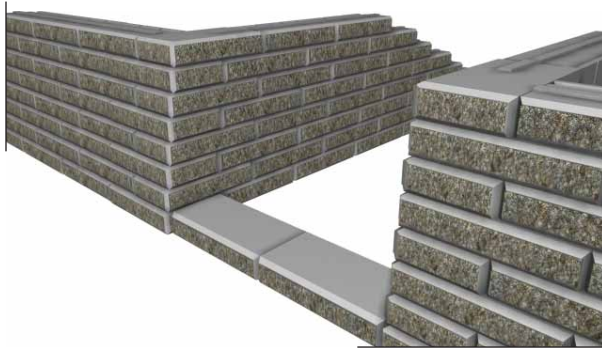

Using SienaStone coping units as the steps, place the first course on the same foundation elevation as side walls. Then, place the granular materials at the back of the first step units at the same top elevation after compaction.

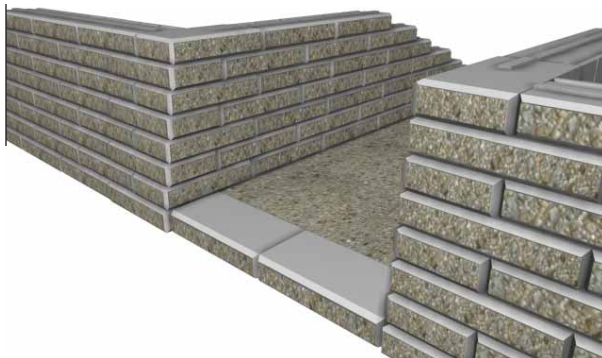

For the second riser, place in a running bond pattern using one full coping unit at middle and two cut coping units at both sides (cut dimension based on the distance between the side walls). The tread depth can be set from 400mm (16 in) to almost any

smaller dimension. Then, place the granular materials at the back of the second step units at the same top elevation after compaction.

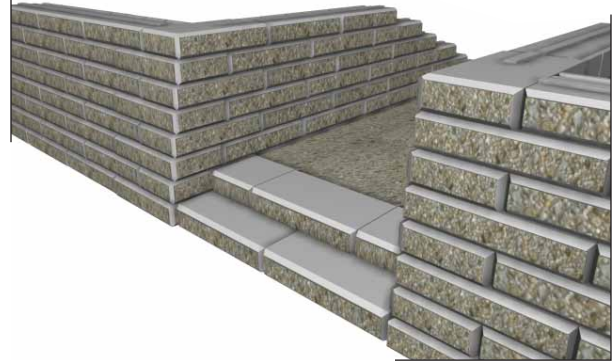

Repeat the previous stage to finish the steps as shown in the drawing.



Core drill handrails as specified in the design.



protruding

Start the wall with two inside 90° corners. The sidewalls must be constructed vertically. Use two 90° corner units (left and right) and a standard coping unit to achieve the first riser steps.

NOTE: Depending on step depth, a portion of the tongue on the corner units may have to be removed.

Then place the granular materials at the back of the first step units at the same top elevation after compaction. At inside corners, part of the tongue on the standard unit will have to be removed before installing the next course.

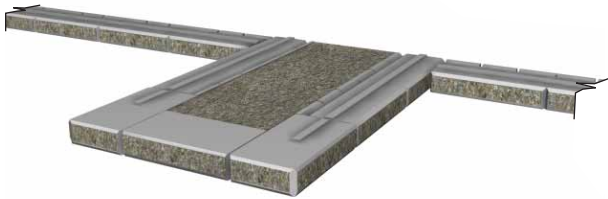

Repeat the previous stage for the second course. Except for at inside 90° corners, part of the tongue on the unit has to be removed for placing the next course of units as shown in the drawing.

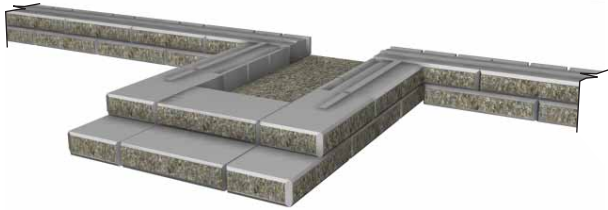

Repeat the previous stages to finish the steps as shown in the drawing.

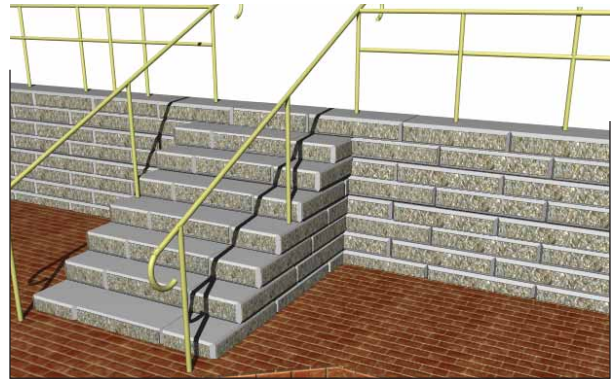

Core drill handrails as specified in the design.



conventional SRWs

If done correctly, terracing can be an effective way to reduce loading and gain greater overall height, while still maintaining an aesthetic appearance.

Generally, a good rule of thumb is to set the distance from the back of the lower wall to the face of the upper wall to be greater than the height of the lower wall. If there is a slope between the two walls, this separation will need to be increased.

It is recommended that a qualified engineer review the terraced SRW design and site soil conditions, specifically checking the global stability of the proposed structure.



reinforced SRWs

Reinforced SRW walls can be designed to support upper terraces that are in close proximity to the back of the wall. Generally, the further the upper wall(s) are offset from the top of the lower wall, the less expensive the design will be. Once a minimum offset distance is established in the design, this must be adhered to throughout the structure.

The loads produced by terraced walls can be great. As an example, a small 0.6m (2.0ft) high wall produces a load equivalent to a heavy traffic surcharge on the lower wall. These loads may be reduced by increasing the separation between the walls or increasing the foundation depth of the upper wall. Wherever possible, the lower wall should be higher than the upper wall.

It is recommended that a qualified engineer review the terraced SRW design and site soil conditions, specifically checking the global stability of the proposed structure.

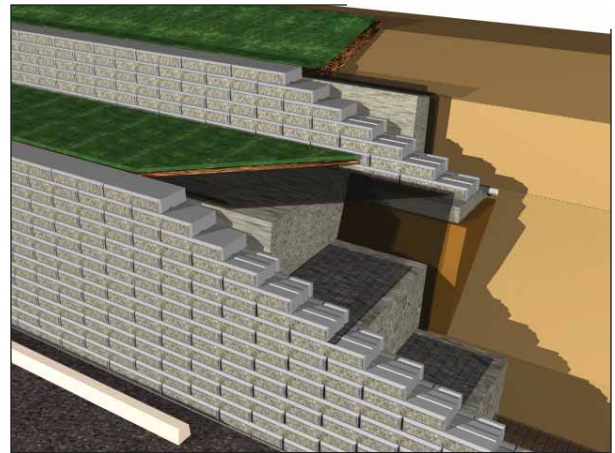



Typically it is inadvisable to end any retaining wall abruptly. If proper care is not taken at the ends of the wall, the infill or drainage material may be eroded, leading to undesirable settlement and possible failure. There are several ways to finish off the end of a retaining wall:

90° return end

A corner (90° shown) could be constructed to run the wall into the slope that is being retained, thereby containing the granular material behind the wall.

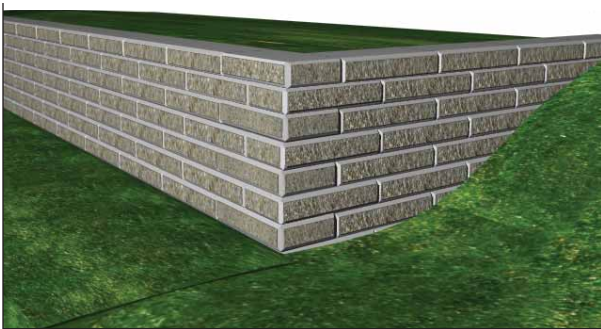

stepped down end

The wall could be extended and stepped down to a reasonable height to allow the ground to be graded around the wall end.

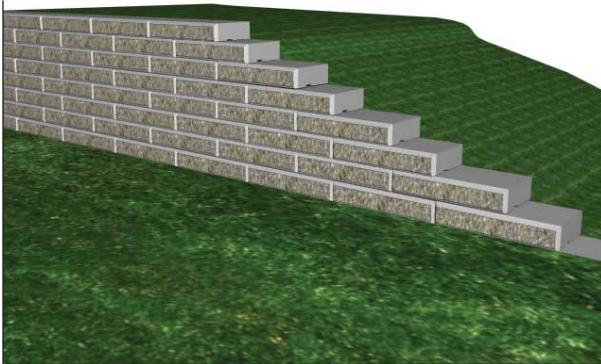

abut existing structure

The wall could be abutted to an existing structure. This would involve cutting the retaining wall blocks in order to maintain the running-bond pattern. An expansion joint (25mm asphalt-impregnated fibre-board) should be placed between the retaining wall and the structure. This will allow the wall to move slightly while still containing the granular material. Note that if the existing structure's footing extends under the retaining wall for a short distance, this could lead to differential settlement and in turn, cracking of the SRW units or separation between the blocks.

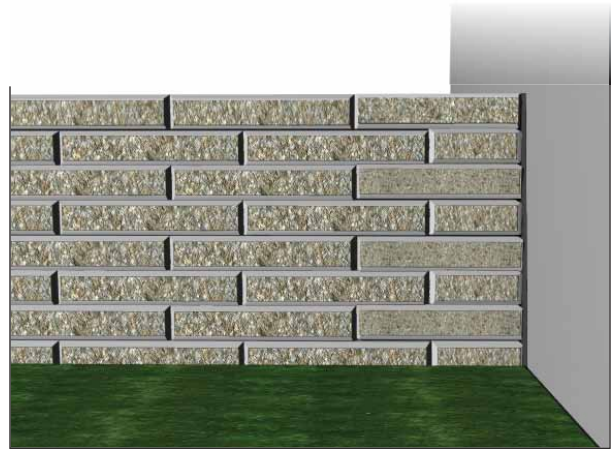

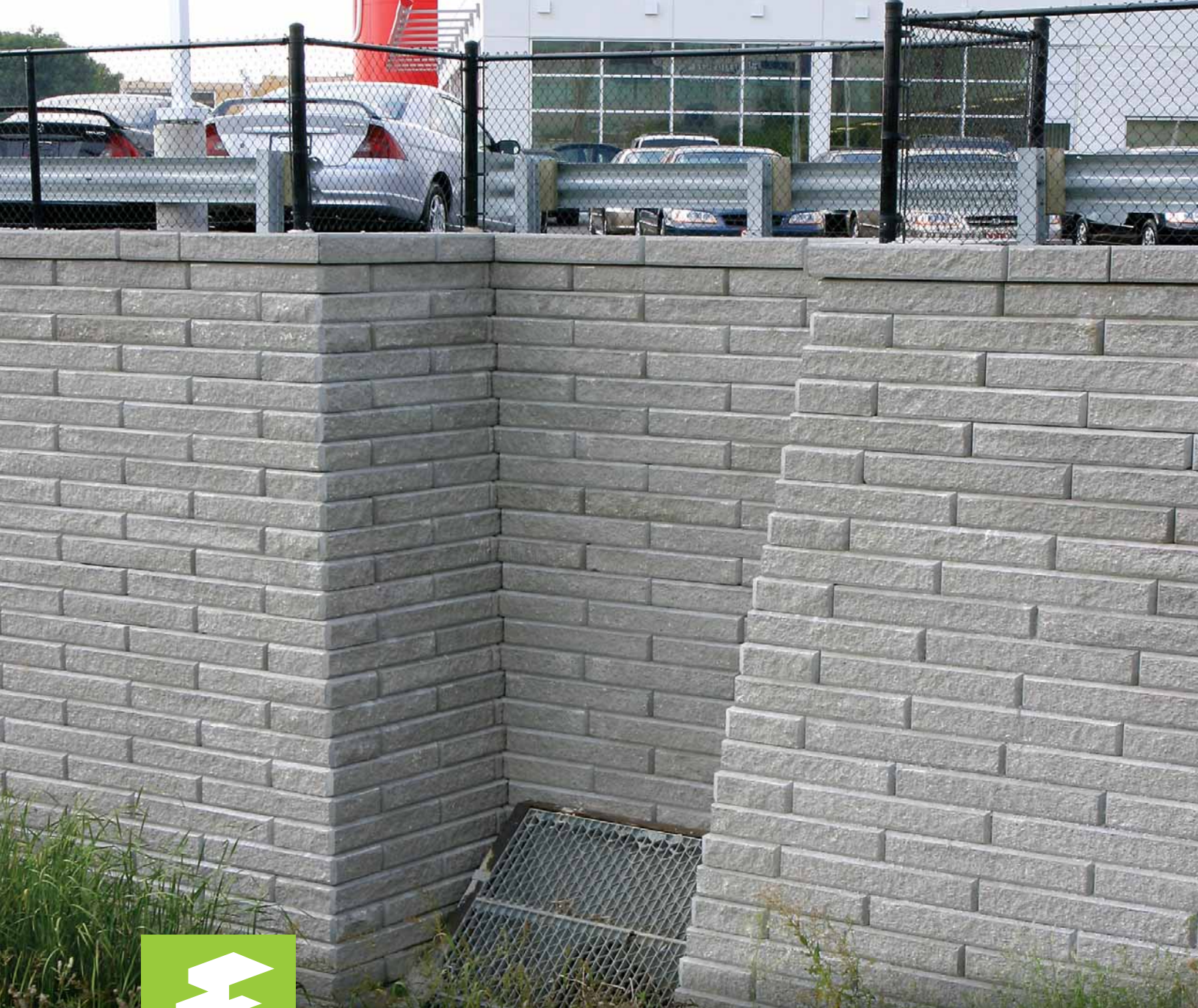

SienaStone is designed so walls can be constructed as either battered or vertical from the same element



Since 1974, innovation has been a way of life for Risi Stone Systems. Today, Risi Stone Systems' retaining walls are the products of choice for landscape, construction and municipal projects internationally.

The patented components, developed by Risi Stone Systems, have been licensed to concrete producers in major markets throughout the world. These producers employ the latest computer and robotic technology in the production of the finest modular concrete retaining wall system.

For more information on the right product for your project,
visit our website

www.risistone.com

or contact us at 1.800.626.WALL • info@risistone.com

Manufactured under licence from



RisiStone
retaining wall systems

The proprietary products and designs described herein are covered under one or more of the following: US Pat. 4,815,897 • US Pat. 4,490,075
US Pat. 5,622,456 • US Pat. 5,064,313 • US Pat. D 403,437 • US Pat. D 403,785 • US Pat. D 370,272 • Cdn. Pat. 1,182,295 • Cdn. Pat. 1,204,296
Cdn. Pat. 2,145,344 • Cdn. Pat. 2,017,578 • Ind. Des. 83,773 • Ind. Des. 78,184.
Other domestic and foreign patents and designs are pending.