

LEDGESTONE™

UNILOCK®

TECH SHEET

THICKNESS 150MM

REGION CHICAGO



UNILOCK® Exclusive Technologies

■ REALA™



APPLICATIONS

Note: Not all sizes are suitable for every application. Contact Unilock Representative for assistance.

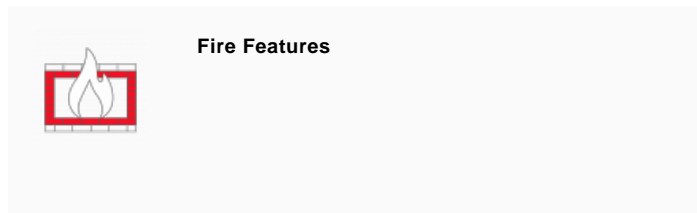
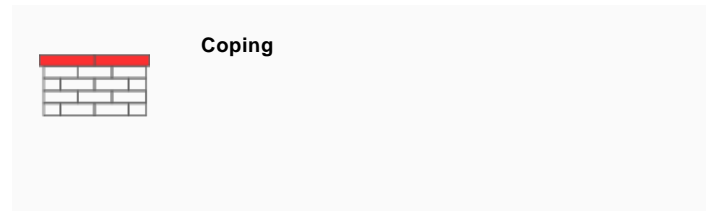
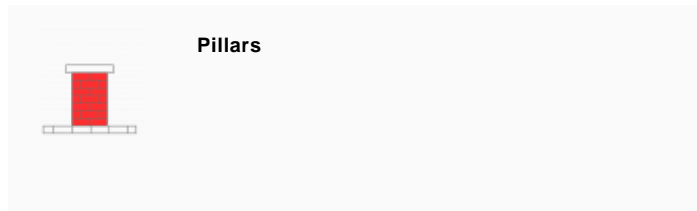
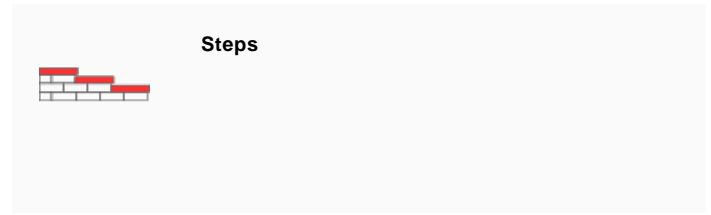
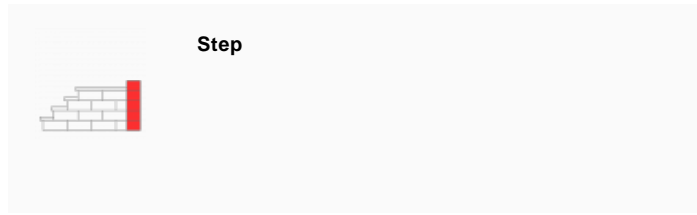

COLORS

**BUFF
FINISH: FLAGSTONE**



STEP 48"X24"
1,220mm x 150mm x 610mm
48" x 5 7/8" x 24"



STEP 72"X24"
1,830mm x 150mm x 610mm
72" x 5 7/8" x 24"

**GREY
FINISH: FLAGSTONE**

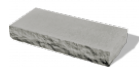

STEP 48"X24"
1,220mm x 150mm x 610mm
48" x 5 7/8" x 24"



STEP 72"X24"
1,830mm x 150mm x 610mm
72" x 5 7/8" x 24"

TYPICAL CROSS SECTION

Note: Base, screed bed, infill aggregates and or reinforcements may vary based on project requirements or as specified by engineer.

LEDGESTONE STEPS

1. UNITS ARE PLACED DIRECTLY OVER GRAVEL BASE
2. ADHESIVE - OPTIONAL
3. 0.5 DEGREE FORWARD SLOPE FOR DRAINAGE

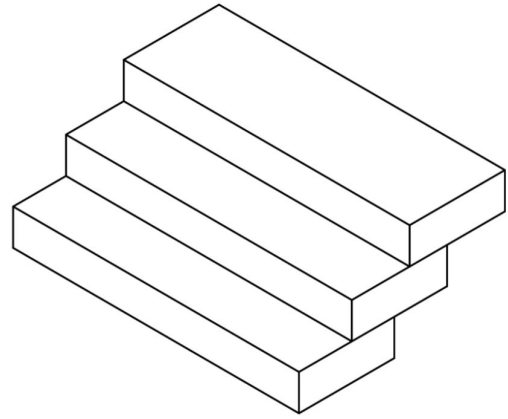
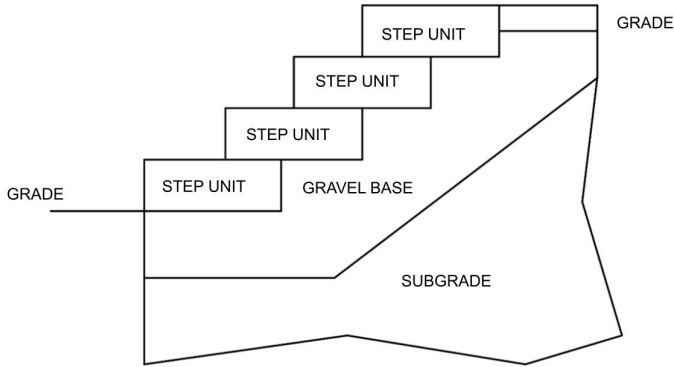

PACKAGING

	CLOSED-END COPING	PILLAR CAP 24"	COPING	FULLNOSE COPING	LARGE COPING	LARGE CLOSED-END COPING	LARGE STEP TREAD
UNIT THICKNESS (MM)	70	100	70	60	70	70	70
LAYERS PER BUNDLE	4	5	4	13	4	4	4
FCFT PER BUNDLE	5.52	3.28	5.52	5.12	6.87	6.87	6.87
FCFT PER LAYER	1.38	0.66	1.38	0.39	1.72	1.72	1.72
FCFT PER UNIT	0.46	0.66	0.46	0.39	0.57	0.57	0.57
UNITS PER BUNDLE	12	5	12	13	12	12	12
UNITS PER LAYER	3	1	3	1	3	3	3
LBS PER BUNDLE	795.96	795.01	771.96	723	1,128	1,116	1,049
LBS PER LAYER	198.99	159	192.99	55.62	282	279	262.25
LBS PER UNIT	66.33	159	64.33	55.62	94	93	87.42

PACKAGING

	STEP 48"X24"	STEP 72"X24"	PILLAR CAP 29"	FIREPIT COPING
UNIT THICKNESS (MM)	150	150	100	65
LAYERS PER BUNDLE	3	3	5	6
FCFT PER BUNDLE	5.91	8.86	-	-
FCFT PER LAYER	1.97	2.95	-	-
FCFT PER UNIT	1.97	2.95	-	-
UNITS PER BUNDLE	3	3	5	48
UNITS PER LAYER	1	1	1	4
LBS PER BUNDLE	1,669	2,439	1,030	1,704
LBS PER LAYER	556.33	813	206	284
LBS PER UNIT	556.33	813	206	35.50

INSTALLATION NOTES

Ledgestone™

Ledgestone is a universal coping system that is turning heads with its remarkably natural appearance. Featuring pitched edges to work interchangeably with any wall, the design selections are optimized.

Applications – Coping for steps, pool edges, planters and walls. Units are designed for straight applications but radius applications can be achieved by cutting tapered units.

Connection – non-mechanical connection. Use appropriate concrete adhesive for connection between units. Install with tight joints or 3/16" gap between units and amend with an exterior latex caulking. Cutting may be required; a diamond blade saw is required to cut coping properly. Glue all coping using a specially formulated concrete adhesive that is strong and will not break down over time. Always read adhesive manufacturers' directions prior to gluing. NOTE: always scarify (rough-up) the back surface of the coping units with a grinder prior to gluing so that you will have a strong secure connection.

Note: always slope Ledgestone units slightly (from front to back or back to front) to prevent pooling of water on the surface.

Handling – Handle gently to avoid chipping edges.

Contact Unilock Representative for actual color samples and availability. Unilock reserves the right to change product information without notice.

PDF Generated April 25, 2024, 11:24 am

UNILOCK