

# 2026 PRODUCT DATA

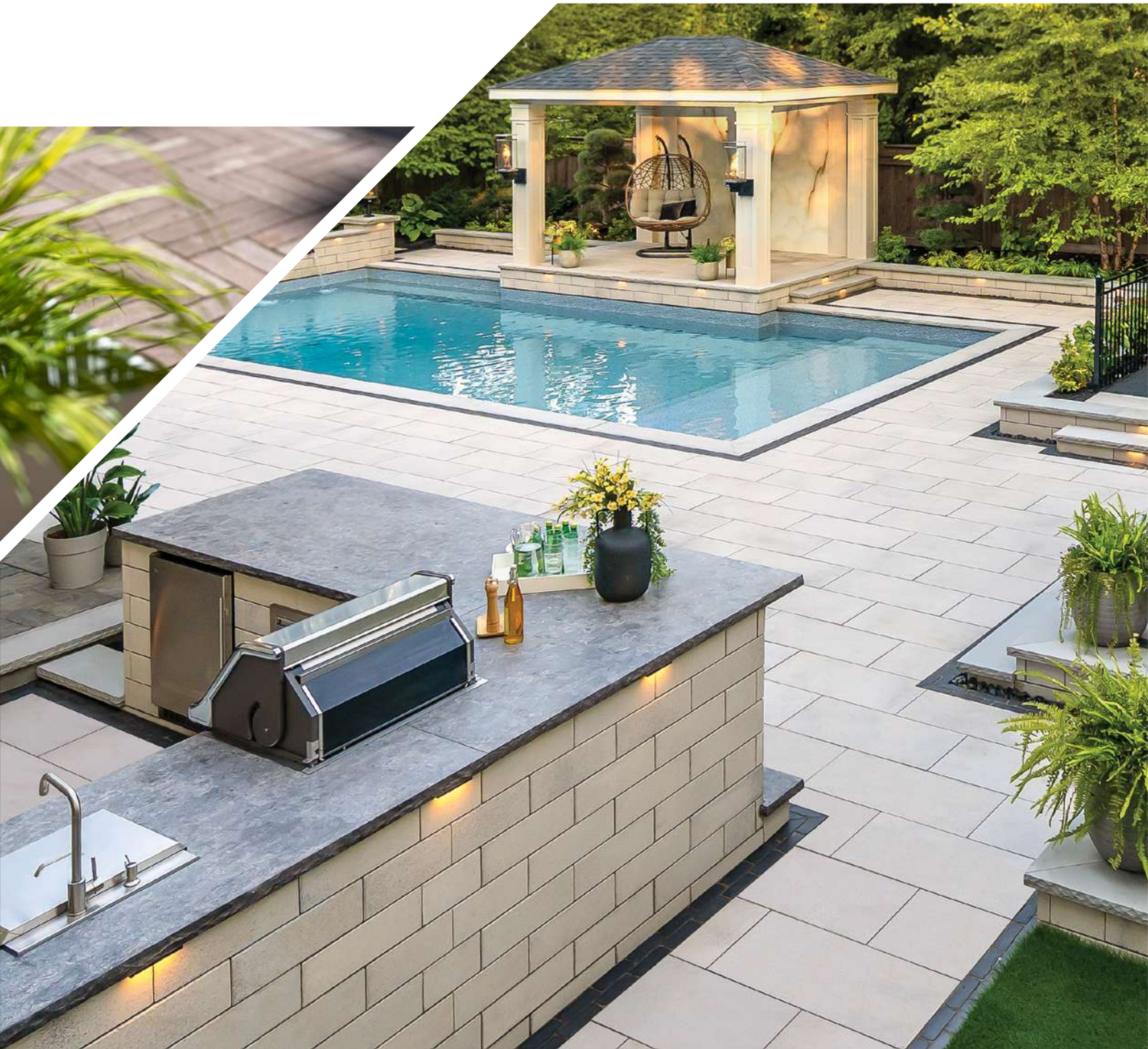

TRANSFORMING  
HARDSCAPES



# **VIEW**

**AR**

LANDSCAPE VISUALIZER

Exclusive to **UNILOCK**

## ***IMPRESS CLIENTS ON THE SPOT***

Simply pan the yard using Uview™ and bring your vision to life in real time with pavers, walls, and vertical elements to get homeowners excited about the possibilities.



**DOWNLOAD  
NOW**

**PART OF A COMPLETE TOOL-KIT**

** LEVEL™**

** VISION™**  
— 3D LANDSCAPE CREATOR —

***SPEED-CALC™***  
— PAVER AND WALL CALCULATOR —

**PAVERS**

- 4 Arcana™
- 5 Artline™ Smooth & IL Campo Finish
- 6 Artline™ Umbriano® Finish
- 7 Beacon Hill™ Flagstone 60mm
- 8 Beacon Hill™ Flagstone 80mm
- 9 Beacon Hill™ Smooth 60mm
- 10 Beacon Hill™ Smooth with EasyClean
- 11 Beacon Hill™ Smooth 80mm
- 12 Bristol Valley®
- 13 Brussels Block®
- 14 Copthorne®
- 15 Courtstone®
- 16 Eco-Hex™
- 17 Eco-Priora™
- 18 Eco-Priora™ Premier
- 19 Eco-Promenade® Ecoterra
- 20 Eco-Promenade® Series
- 21 Eco-Promenade® Umbriano®
- 22 Hex™
- 23 Holland Premier™
- 24 Hollandstone™
- 25 Il Campo®
- 26 Mattoni™
- 27 Natural Stone
- 32 Nordic Cobble™
- 33 24 x 24 Premier
- 34 Porcelain
- 36 Promenade™ 4x12" - 100mm
- 37 Promenade™ 4x16 - 100mm
- 38 Promenade™ 8x24" - 100mm
- 39 Richcliff®
- 40 Series™
- 41 Soreno™
- 42 Thornbury™
- 43 Town Hall®
- 44 Treo™ Smooth
- 45 Tribeca Cobble™
- 46 Turfstone™
- 47 Umbriano® 50mm Slabs
- 48 Umbriano® 60mm
- 49 Umbriano® 60mm Slabs
- 50 Umbriano® 70mm
- 51 Umbriano® 80mm
- 52 Umbriano® 100mm
- 53 Urban™
- 54 Urban™ Slabs
- 55 Westport™

**WALLS**

- 56 Brussels Dimensional Stone®
- 57 DuraHold®
- 58 DuraHold® Coping
- 59 DuraHold 2®
- 60 Estate Wall™
- 61 Lineo™ Dimensional Stone
- 62 Pisa™
- 63 Pisa™ Smooth XL
- 64 Quarry™ Smooth
- 65 Rivercrest® Wall
- 66 Rivercrest® Pillar and Fire Pit kit
- 67 SienaEdge™
- 68 SienaStone™
- 69 SienaStone® Smooth
- 70 SienaStone® Smooth Step
- 71 U-Cara®
- 71 U-Cara® Multi-Face Wall System
- 73 U-Cara® Fascia Panels
- 75 U-Cara® Backer
- 76 U-Cara® Modular System
- 77 U-Cara® Wall Mount System

**COPING, STEPS, PILLAR CAPS AND FIRE FEATURES**

- 80 Brussels Fullnose™
- 81 Endura™ Coping
- 83 Ledgestone™
- 85 Umbriano® Coping
- 86 Sunset Fire Pit Kit
- 87 Unilock Elements

**ACCESSORIES**

- 89 SkyView™
- 90 Natural Stone Cleaners & Sealers
- 90 Sealers
- 91 Sands
- 92 X & T Slab Spacers
- 92 Edging Products
- 93 Adhesives
- 93 Geotextiles and Fabric Products
- 94 Tools & Accessories
- 94 Base/Drainage Systems
- 95 Turf products
- 96 Accessory Quick Reference Guide
- 98 Polysand Best Practices
- 99 Sealer Best Practices
- 100 Important notes
- 101 Terms and Conditions of Sale
- 102 Unilock Finishes

**DESCRIPTION OF PAVER EDGE DETAILS**

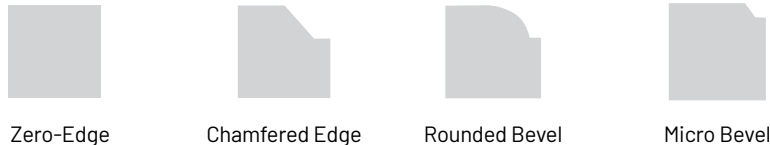



**APPLICATIONS**

Pedestrian, Roof Deck

**APPEARANCE**

Edge Detail - Micro  
Surface Texture - Smooth  
Joint Spacing - 0 mm

**TECHNICAL INFORMATION**

Conforms to ASTM C 1782  
Eligible for LEED v4.1 credits

**// Perfect for roof decks and other raised floor applications.**

Ask us about our Skyview™ pedestal system.  
See page 89 for more information.

	12 x 24	18 x 24	24 x 24
Bundle Type	SINGLE	SINGLE	SINGLE
Plant Produced	CHICAGO	CHICAGO	CHICAGO
Thickness (mm)	50 mm	50 mm	50 mm

SQFT PER	Stone	2.00	3.00	4.00
	Bundle	36.00	54.00	72.00

SOLDIER LNFT PER	SqFt	0.99	0.99	0.99
	Bundle	35.55	53.50	71.57

SAILOR LNFT PER	SqFt	1.99	1.33	0.99
	Bundle	71.57	71.57	71.57

UNITS PER	SqFt	0.50	0.33	0.25
	Bundle	18.00	18.00	18.00

LBS PER	Unit	48	72	96
	Bundle	864	1,296	1,728

Colors	Reflectance	Stock	Stock	Stock
Avorio	SR .56 SRI 66	SO	SO	SO
Corvara	SR .32 SRI 34	SO	SO	SO
Ferrano	SR n/a SRI n/a	SO	SO	SO
Modena	SR .46 SRI 53	SO	SO	SO
Vivanto	SR .18 SRI 16	SO	SO	SO

SLAB SPACERS



**X & T Slab Spacers**  
Bagged & Sold Separately.

LAYING PATTERNS

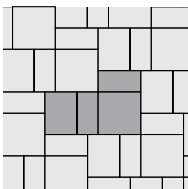

Random A

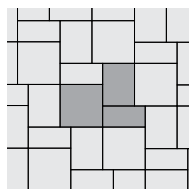

Random C

SINGLE UNITS

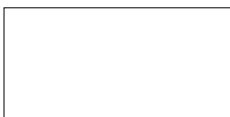

**12 x 24**  
301 x 606 x 50mm  
11 7/8 x 23 7/8 x 2"  
18 Units/Bundle  
2 Sq.Ft./Stone



**18 x 24**  
453 x 606 x 50mm  
17 7/8 x 23 7/8 x 2"  
18 Units/Bundle  
3 Sq.Ft./Stone



**24 x 24**  
606 x 606 x 50mm  
23 7/8 x 23 7/8 x 2"  
18 Units/Bundle  
4 Sq.Ft./Stone



AVORIO



CORVARA



FERRANO  
**NEW**



MODENA



VIVANTO

**Notes: Minimum quantities apply. SOLD IN FULL BUNDLES ONLY** and is produced and sold on a required, refundable skid. Unilock offers adjustable and stackable pedestal systems; please contact your Territory Manager for pricing and availability. **Product is not intended for vehicular applications.** All measurements are nominal. Unilock recommends to install Arcana using T and X Slab spacers. Please contact your Territory Manager for more information.



**APPLICATIONS**

Pedestrian, Light Vehicular

**APPEARANCE**

Edge Detail - Micro  
 Surface Texture - Smooth and Brushed  
 Joint Spacing - 3 mm

**TECHNICAL INFORMATION**

Conforms to ASTM C 936  
 Eligible for LEED v4.1 credits

		MULTIPLE SIZES
Bundle Type		RANDOM
Plant Produced		CHICAGO
Thickness (mm)		70 mm
SQFT PER	Stone	-
	Layer	11.66
	Bundle	93.25
PER BUNDLE	Layers	8.00
SOLDIER LNFT PER	SqFt	-
	Layer	-
	Bundle	-
SAILOR LNFT PER	SqFt	-
	Layer	-
	Bundle	-
UNITS PER	SqFt	-
	Layer	24.00
	Bundle	192.00
LBS PER	Unit	-
	Layer	370
	Bundle	2,963

Colors	Reflectance	Stock
Fossil	SR n/a SRI n/a	✓
Granite Fusion	SR .28 SRI 29	✓
Granite Fusion (IL Campo Finish)	SR .28 SRI 29	<b>SO</b>

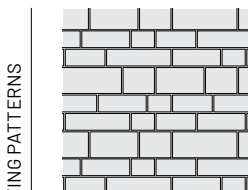
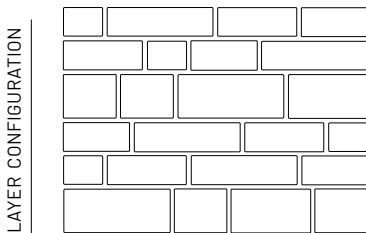

Artline Random A

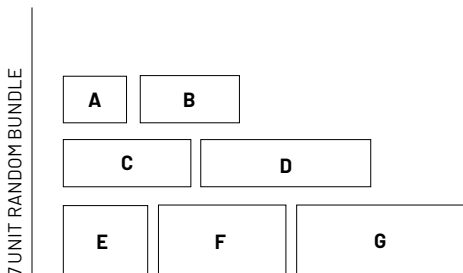

**UNIT A**  
 125 x 169 x 70mm  
 4 7/8 x 6 3/4 x 2 3/4"  
 32 Units/Bundle  
 .23 Sq.Ft./Stone

**UNIT E**  
 187.5 x 225 x 70mm  
 7 1/2 x 8 7/8 x 2 3/4"  
 32 Units/Bundle  
 .45 Sq.Ft./Stone

**UNIT B**  
 125 x 262.5 x 70mm  
 4 7/8 x 10 3/8 x 2 3/4"  
 32 Units/Bundle  
 .35 Sq.Ft./Stone

**UNIT F**  
 187.5 x 337.5 x 70mm  
 7 1/2 x 13 3/8 x 2 3/4"  
 16 Units/Bundle  
 .58 Sq.Ft./Stone

**UNIT C**  
 125 x 337.5 x 70mm  
 4 7/8 x 13 3/8 x 2 3/4"  
 32 Units/Bundle  
 .45 Sq.Ft./Stone

**UNIT G**  
 187.5 x 450 x 70mm  
 7 1/2 x 17 3/4 x 2 3/4"  
 16 Units/Bundle  
 .91 Sq.Ft./Stone

**UNIT D**  
 125 x 450 x 70mm  
 4 7/8 x 17 3/4 x 2 3/4"  
 32 Units/Bundle  
 .61 Sq.Ft./Stone

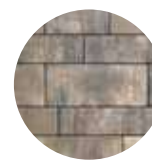

FOSSIL  
**NEW**



GRANITE FUSION



GRANITE FUSION  
(IL Campo Finish)

Notes: IL Campo finish is a Special Order (SO) - Lead time required. Minimum quantities apply. SOLD IN FULL BUNDLES ONLY and is produced and sold on a required, refundable skid. Important: A urethane rubber paver mat must be used to prevent scuffing when compacting. All measurements are nominal. Contact Unilock for more information.



## APPLICATIONS

Pedestrian, Light Vehicular

## APPEARANCE

Edge Detail - Micro

Surface Texture - Umbriano Mottled

Joint Spacing - 3 mm

## TECHNICAL INFORMATION

Conforms to ASTM C 936

Eligible for LEED v4.1 credits

LAYER CONFIGURATION

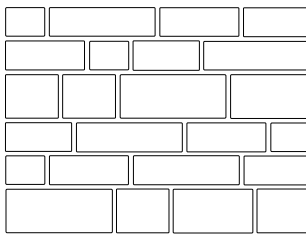

LAYING PATTERNS

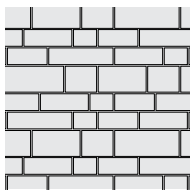

Artline Random A

7 UNIT RANDOM BUNDLE

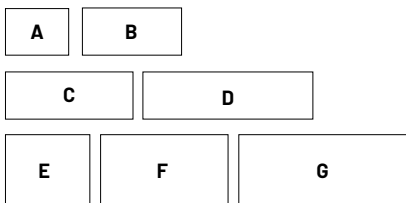

### UNIT A

125 x 169 x 70mm  
4 7/8 x 6 5/8 x 2 3/4"  
32 Units/Bundle  
.23 Sq.Ft./Stone

### UNIT B

125 x 262.5 x 70mm  
4 7/8 x 10 3/8 x 2 3/4"  
32 Units/Bundle  
.35 Sq.Ft./Stone

### UNIT C

125 x 337.5 x 70mm  
4 7/8 x 13 1/4 x 2 3/4"  
32 Units/Bundle  
.45 Sq.Ft./Stone

### UNIT D

125 x 450 x 70mm  
4 7/8 x 17 3/4 x 2 3/4"  
32 Units/Bundle  
.61 Sq.Ft./Stone

### UNIT E

187.5 x 225 x 70mm  
7 3/8 x 8 7/8 x 2 3/4"  
32 Units/Bundle  
.45 Sq.Ft./Stone

### UNIT F

187.5 x 337.5 x 70mm  
7 3/8 x 13 3/8 x 2 3/4"  
16 Units/Bundle  
.58 Sq.Ft./Stone

### UNIT G

187.5 x 450 x 70mm  
7 3/8 x 17 1/4 x 2 3/4"  
16 Units/Bundle  
.91 Sq.Ft./Stone

MULTIPLE SIZES	
Bundle Type	RANDOM
Plant Produced	CHICAGO
Thickness (mm)	70 mm

SQFT PER	Stone	-
	Layer	11.66
	Bundle	93.25

PER BUNDLE	Layers	8.00
------------	--------	------

SOLDIER LNFT PER	SqFt	-
	Layer	-
	Bundle	-

SAILOR LNFT PER	SqFt	-
	Layer	-
	Bundle	-

UNITS PER	SqFt	-
	Layer	-
	Bundle	192.00

LBS PER	Unit	-
	Layer	414
	Bundle	3,310

Colors	Reflectance	Stock
French Grey	SR .35 SRI 38	SO
Midnight Sky	SR .35 SRI 38	SO
Winter Marvel	SR .18 SRI 17	SO



FRENCH GREY



MIDNIGHT SKY



WINTER MARVEL

Notes: Special Order (SO). Minimum quantities apply. Lead time required. SOLD IN FULL BUNDLES ONLY and is produced and sold on a required, refundable skid. Important: A urethane rubber paver mat must be used to prevent scuffing when compacting. All measurements are nominal. Contact Unilock for more information.

# Beacon Hill™ Flagstone 60mm

ENDURACOLOR™



## APPLICATIONS

Pedestrian

## APPEARANCE

Edge Detail - Rounded

Surface Texture - Textured

Joint Spacing - 4 mm

## TECHNICAL INFORMATION

Conforms to ASTM C 936

Eligible for LEED v4.1 credits

Bundle Type	RANDOM
Plant Produced	MICHIGAN
Thickness (mm)	60 mm

SQFT PER	Stone	-
	Layer	11.66
	Bundle	104.91

PER BUNDLE	Layers	9.00
------------	--------	------

SOLDIER LNFT PER	SqFt	-
	Layer	-
	Bundle	-

SAILOR LNFT PER	SqFt	0.80
	Layer	9.35
	Bundle	84.15

UNITS PER	SqFt	-
	Layer	8.00
	Bundle	72.00

LBS PER	Unit	-
	Layer	320
	Bundle	2,879

Colors	Reflectance	Stock
Birch	SR n/a SRI n/a	✓
Fossil	SR .22 SRI 21	✓
Granite Fusion	SR .30 SRI 32	✓
Sierra	SR n/a SRI n/a	✓

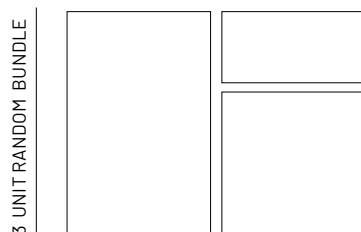
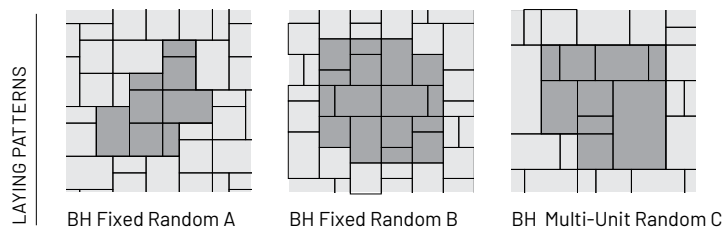
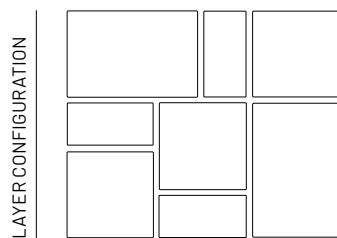

**LARGE RECTANGLE**  
 380 x 570 x 60mm  
 15 x 22 1/2 x 2 3/8"  
 18 Units/Bundle  
 2.08 SqFt./Stone

**SQUARE**  
 380 x 380 x 60mm  
 15 x 15 x 2 3/8"  
 27 Units/Bundle  
 1.39 Sq.Ft./Stone

**SMALL RECTANGLE**  
 380 x 190 x 60mm  
 15 x 7 1/2 x 2 3/8"  
 27 Units/Bundle  
 .69 Sq.Ft./Stone

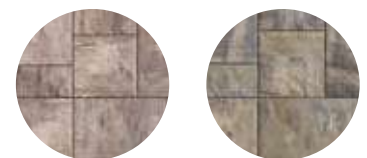

BIRCH

FOSSIL

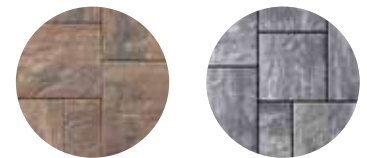

SIERRA

GRANITE FUSION

Notes: **SOLD IN FULL BUNDLES ONLY.** This product is not intended for vehicular applications. **Important:** A urethane rubber paver mat must be used to prevent scuffing when compacting. All measurements are nominal. Contact Unilock for more information.

# Beacon Hill™ Flagstone 80mm



## APPLICATIONS

Pedestrian, Light Vehicular

## APPEARANCE

Edge Detail - Rounded

Surface Texture - Textured

Joint Spacing - 4 mm

## TECHNICAL INFORMATION

Conforms to ASTM C 936

Eligible for LEED v4.1 credits

Bundle Type	RANDOM
Plant Produced	MICHIGAN
Thickness (mm)	80 mm

SQFT PER	Stone	-
	Layer	10.46
	Bundle	73.22

PER BUNDLE	Layers	7.00
------------	--------	------

SOLDIER LNFT PER	SqFt	-
	Layer	-
	Bundle	-

SAILOR LNFT PER	SqFt	0.85
	Layer	8.86
	Bundle	62.00

UNITS PER	SqFt	-
	Layer	8.86
	Bundle	56.00

LBS PER	Unit	-
	Layer	382
	Bundle	2,679

Colors	Reflectance	Stock
Fossil	SR .22 SRI 21	SO
Granite Fusion	SR .30 SRI 32	SO

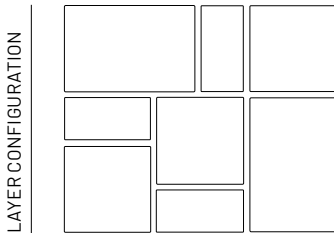

FOSSIL



GRANITE FUSION

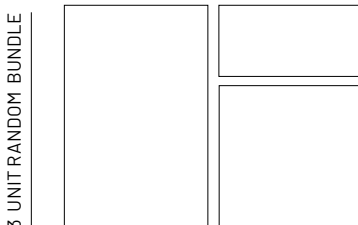

**LARGE RECTANGLE**  
 360 x 540 x 80mm  
 14 x 21 x 3 1/8"  
 14 Units/Bundle  
 2.09 Sq.Ft./Stone

**SQUARE**  
 360 x 360 x 80mm  
 14 x 14 x 3 1/8"  
 21 Units/Bundle  
 1.40 Sq.Ft./Stone

**SMALL RECTANGLE**  
 180 x 360 x 80mm  
 7 x 14 1/4 x 3 1/8"  
 21 Units/Bundle  
 0.70 Sq.Ft./Stone

**Notes: Special Order (SO).** Minimum quantities apply. **Lead time required. SOLD IN FULL BUNDLES ONLY** and is produced and sold on a required, refundable skid. **Important: A urethane rubber paver mat must be used to prevent scuffing when compacting.** All measurements are nominal. Contact Unilock for more information.



## APPLICATIONS

Pedestrian

## APPEARANCE

Edge Detail - Rounded

Surface Texture - Smooth

Joint Spacing - 4 mm

## TECHNICAL INFORMATION

Conforms to ASTM C 936

Eligible for LEED v4.1 credits

			XL	SMALL RECTANGLE
Bundle Type	RANDOM		SINGLE	SINGLE
Plant Produced	MICHIGAN		MICHIGAN	MICHIGAN
Thickness (mm)	60 mm		60 mm	60 mm

SQFT PER	Stone	-	5.83	0.78
	Layer	11.66	11.66	11.66
	Bundle	104.91	81.60	104.91

PER BUNDLE	Layers	9.00	7.00	9.00
------------	--------	------	------	------

SOLDIER LNFT PER	SqFt	-	0.32	0.80
	Layer	-	3.74	9.35
	Bundle	-	26.18	84.15

SAILOR LNFT PER	SqFt	0.80	0.53	1.60
	Layer	9.35	6.23	18.70
	Bundle	84.15	43.61	168.31

UNITS PER	SqFt	-	0.17	1.29
	Layer	8.00	2.00	15.00
	Bundle	72.00	14.00	135.00

LBS PER	Unit	-	160	21
	Layer	320	320	320
	Bundle	2,879	2,239	2,879

Colors	Reflectance	Stock	Stock	Stock
Birch	SR n/a SRI 30	✓	-	✓
Fossil	SR n/a SRI 21	✓	✓	✓
Granite Fusion	SR .28 SRI 29	✓	✓	✓
Grindstone	SR n/a SRI n/a	✓	-	✓
Oat Beige	SR n/a SRI n/a	✓	-	✓
Dark Charcoal	SR n/a SRI n/a	-	-	✓

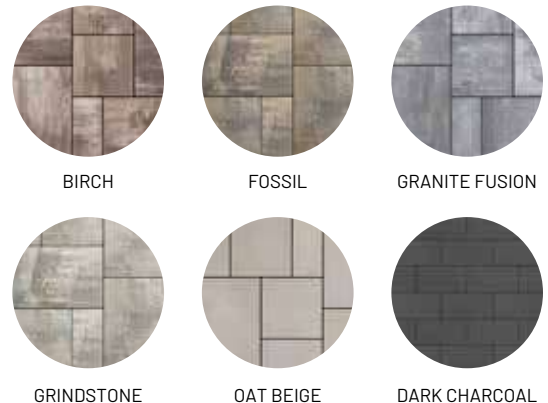
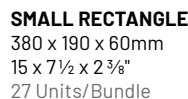
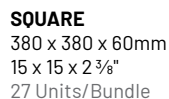
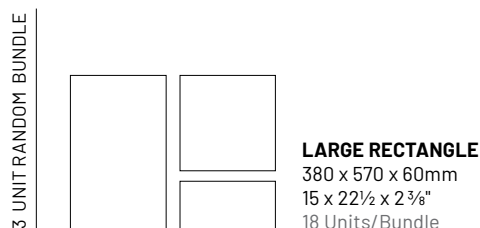
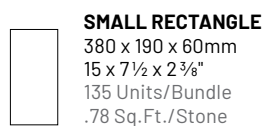
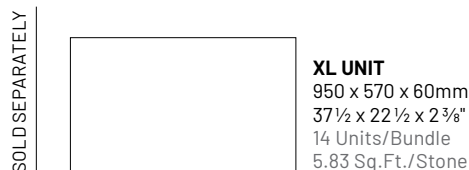
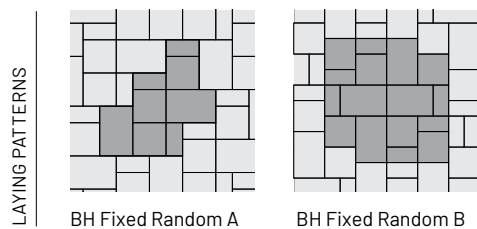
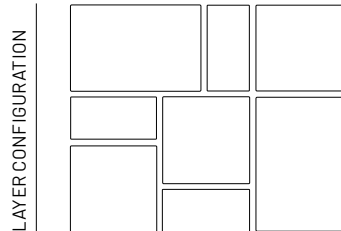

**Notes: SOLD IN FULL BUNDLES ONLY.** XL unit is produced and sold on a required refundable skid. This product is not intended for vehicular applications. **Important: A urethane rubber paver mat must be used to prevent scuffing when compacting.** All measurements are nominal. Contact Unilock for more information.



## APPLICATIONS

Pedestrian

## APPEARANCE

Edge Detail - Rounded

Surface Texture - Smooth

Joint Spacing - 4 mm

## TECHNICAL INFORMATION

Conforms to ASTM C 936

Eligible for LEED v4.1 credits

			SLAB
	Bundle Type	RANDOM	SINGLE
	Plant Produced	HARRISON	HARRISON
	Thickness (mm)	60 mm	60mm

SQFT PER	Stone	-	5.83
	Layer	11.66	11.66
	Bundle	116.57	116.57

PER BUNDLE	Layers	10.00	10.00
------------	--------	-------	-------

SOLDIER LNFT PER	SqFt	-	0.32
	Layer	-	3.74
	Bundle	-	37.40

SAILOR LNFT PER	SqFt	0.80	0.53
	Layer	9.35	6.23
	Bundle	93.50	62.30

UNITS PER	SqFt	-	0.17
	Layer	-	2.00
	Bundle	80.00	20.00

LBS PER	Unit	-	160
	Layer	320	319.93
	Bundle	3,199	3,199

Colors	Reflectance	Stock	Stock
Biscotti	SR n/a SRI n/a	SO	SO
Fossil	SR .22 SRI 21	SO	SO
Granite Fusion	SR .28 SRI 29	SO	SO
Platinum	SR n/a SRI n/a	SO	SO

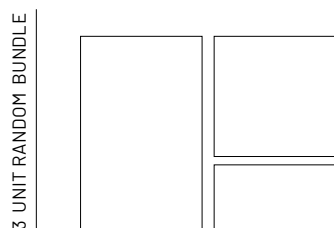
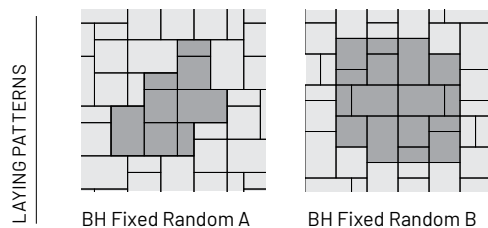
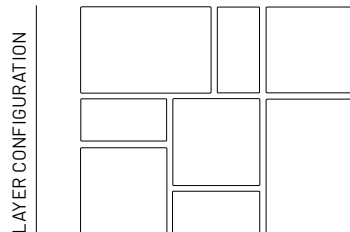

**LARGE RECTANGLE**  
380 x 570 x 60mm  
15 x 22 1/2 x 2 3/8"  
20 Units/Bundle

**SQUARE**  
380 x 380 x 60mm  
15 x 15 x 2 3/8"  
30 Units/Bundle

**SMALL RECTANGLE**  
380 x 190 x 60mm  
15 x 7 1/2 x 2 3/8"  
30 Units/Bundle

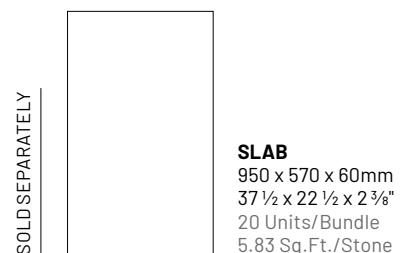

BISCOTTI  
**NEW**



FOSSIL



GRANITE FUSION



PLATINUM

**Notes: Special Order (SO).** Minimum quantities apply. **Lead time required. SOLD IN FULL BUNDLES ONLY.** XL unit is produced and sold on a required refundable skid. This product is not intended for vehicular applications. **Important: A urethane rubber paver mat must be used to prevent scuffing when compacting.** All measurements are nominal. Contact Unilock for more information.

# Beacon Hill™ Smooth 80mm



## APPLICATIONS

Pedestrian, Light Vehicular

## APPEARANCE

Edge Detail - Rounded

Surface Texture - Smooth

Joint Spacing - 4 mm

## TECHNICAL INFORMATION

Conforms to ASTM C 936

Eligible for LEED v4.1 credits

Bundle Type	RANDOM
Plant Produced	MICHIGAN
Thickness (mm)	80 mm

SQFT PER	Stone	-
	Layer	10.46
	Bundle	73.22

PER BUNDLE	Layers	7.00
------------	--------	------

SOLDIER LNFT PER	SqFt	-
	Layer	-
	Bundle	-

SAILOR LNFT PER	SqFt	0.85
	Layer	8.86
	Bundle	62.01

UNITS PER	SqFt	-
	Layer	8.00
	Bundle	56.00

LBS PER	Unit	-
	Layer	383
	Bundle	2,679

Colors	Reflectance	Stock
Fossil	SR 22 SRI 21	✓
Granite Fusion	SR .28 SRI 29	✓

LAYER CONFIGURATION

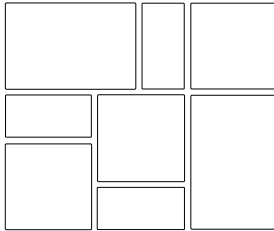

LAYING PATTERN

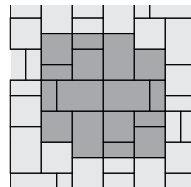
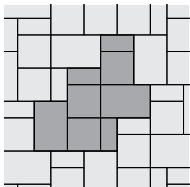

BH Fixed Random A

BH Fixed Random B

3 UNIT RANDOM BUNDLE

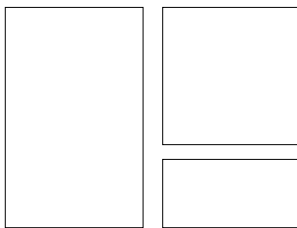

**LARGE RECTANGLE**  
360 x 540 x 80mm  
14 1/8 x 21 1/4 x 3 1/8"  
14 Units/Bundle

**SQUARE**  
360 x 360 x 80mm  
14 1/8 x 14 1/8 x 3 1/8"  
21 Units/Bundle

**SMALL RECTANGLE**  
360 x 180 x 80mm  
14 1/8 x 7 7/16 x 3 1/8"  
21 Units/Bundle



FOSSIL

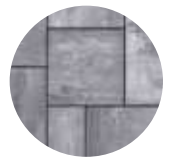

GRANITE FUSION

Notes: SOLD IN FULL BUNDLES ONLY. Important: A urethane rubber paver mat must be used to prevent scuffing when compacting. All measurements are nominal. Contact Unilock for more information.



## APPLICATIONS

Pedestrian

## APPEARANCE

Edge Detail - Zero

Surface Texture - Textured

Joint Spacing - 7 mm

## TECHNICAL INFORMATION

Conforms to ASTM C 936

Eligible for LEED v4.1 credits

			XL
Bundle Type	RANDOM		SINGLE
Plant Produced	HARRISON		HARRISON
Thickness (mm)	60 mm		60 mm

SQFT PER	Stone	-	5.83
	Layer	11.66	11.66
	Bundle	116.57	116.57

PER BUNDLE	Layers	10.00	10.00
------------	--------	-------	-------

SOLDIER LNFT PER	SqFt	-	0.32
	Layer	-	3.74
	Bundle	-	37.40

SAILOR LNFT PER	SqFt	0.80	0.53
	Layer	9.35	6.23
	Bundle	93.50	62.30

UNITS PER	SqFt	-	0.17
	Layer	8.00	2.00
	Bundle	80.00	20.00

LBS PER	Unit	-	160
	Layer	311	319.93
	Bundle	3,113	3,199

Colors	Reflectance	Stock	Stock
Bavarian	SR n/a SRI n/a	✓	SO
Biscotti	SR n/a SRI n/a	✓	SO
Fossil	SR .22 SRI 21	✓	SO
Steel Mountain	SR n/a SRI n/a	✓	SO

LAYER CONFIGURATION

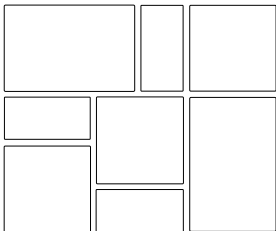

LAYING PATTERNS

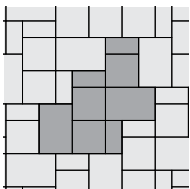

BV Fixed Random A

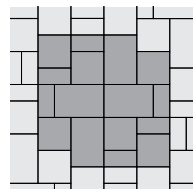

BV Fixed Random B



BAVARIAN

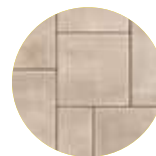

BISCOTTI  
NEW



FOSSIL



STEEL MOUNTAIN

3 UNIT - RANDOM BUNDLE

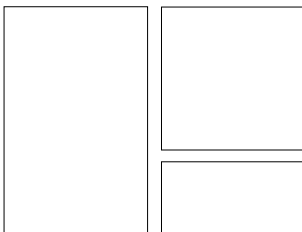

### LARGE RECTANGLE

380 x 570 x 60mm  
15 x 22 1/2 x 2 3/8"  
20 Units/Bundle  
2.08 SqFt/Stone

### SQUARE

380 x 380 x 60mm  
15 x 15 x 2 3/8"  
30 Units/Bundle  
1.39 Sq.Ft./Stone

### SMALL RECTANGLE

380 x 190 x 60mm  
15 x 7 1/2 x 2 3/8"  
30 Units/Bundle  
.69 Sq.Ft./Stone

SINGLE UNIT

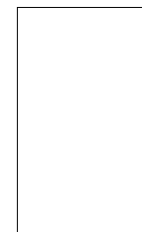

### XL UNIT

950 x 570 x 60mm  
37 1/2 x 22 1/2 x 2 3/8"  
20 Units/Bundle  
5.83 Sq.Ft./Stone

**Notes: Special Order (SO).** Minimum quantities apply. **Lead time required.** **SOLD IN FULL BUNDLES ONLY** and is produced and sold on a required, refundable skid. This product is not intended for vehicular applications. **Important: A urethane rubber paver mat must be used to prevent scuffing when compacting.** All measurements are nominal. Contact Unilock for more information.

# Brussels Block®



## APPLICATIONS

Pedestrian, Light Vehicular

## APPEARANCE

Edge Detail - Zero

Surface Texture - Weathered

Joint Spacing - 2 mm

## TECHNICAL INFORMATION

Conforms to ASTM C 936

Eligible for LEED v4.1 credits

	HALF	STANDARD	XL
Bundle Type	SINGLE	SINGLE	SINGLE
Plant Produced	MICHIGAN	MICHIGAN	MICHIGAN
Thickness (mm)	70 mm	70 mm	70 mm

SQFT PER	Stone	0.20	0.40	0.80
	Layer	12.47	11.99	9.59
	Bundle	99.79	95.94	95.94

PER BUNDLE	Layers	8.00	8.00	10.00
------------	--------	------	------	-------

SOLDIER LNFT PER	SqFt	1.72	1.42	0.85
	Layer	21.50	17.03	8.19
	Bundle	172.00	136.22	81.90

SAILOR LNFT PER	SqFt	2.95	1.71	1.43
	Layer	36.79	20.47	13.70
	Bundle	294.30	163.78	137.00

UNITS PER	SqFt	5.05	2.50	1.25
	Layer	63.00	30.00	12.00
	Bundle	504.00	240.00	120.00

LBS PER	Unit	6	13	26
	Layer	399	384	307
	Bundle	3,195	3,072	3,072

Colors	Reflectance	Stock	Stock	Stock
Charcoal	SR n/a SRI n/a	✓	-	-
Limestone	SR .28 SRI 29	✓	✓	✓
Coffee Creek	SR n/a SRI n/a	✓	✓	✓
Sandstone	SR .41 SRI 46	✓	✓	✓
Sierra	SR n/a SRI n/a	✓	✓	✓

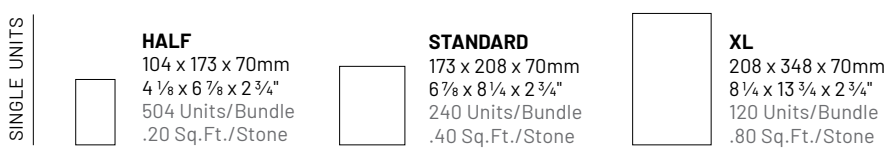
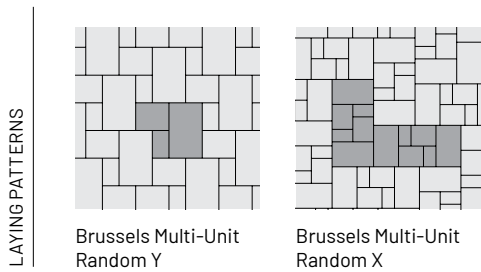
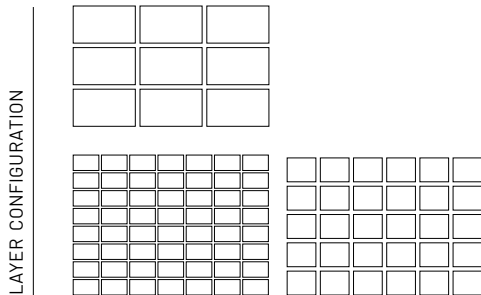

Notes: SOLD IN FULL BUNDLES ONLY. Important: A urethane rubber paver mat must be used to prevent scuffing when compacting. All measurements are nominal. Contact Unilock for more information.



## APPLICATIONS

Pedestrian, Light Vehicular, Border/Accents

## APPEARANCE

Edge Detail - n/a

Surface Texture - Textured

Joint Spacing - 3 mm

## TECHNICAL INFORMATION

Conforms to ASTM C 936

Eligible for LEED v4.1 credits

Bundle Type	SINGLE
Plant Produced	AYR
Thickness (mm)	60 mm

SQFT PER	Stone	0.15
	Layer	11.15
	Bundle	89.20

PER BUNDLE	Layers	8.00
------------	--------	------

SOLDIER LNFT PER	SqFt	1.43
	Layer	15.99
	Bundle	127.95

SAILOR LNFT PER	SqFt	4.41
	Layer	49.21
	Bundle	393.70

UNITS PER	SqFt	6.73
	Layer	75.00
	Bundle	600.00

LBS PER	Unit	4
	Layer	294
	Bundle	2,349

Colors	Reflectance	Stock
Arctic Grey	SR .79 SRI 57	✓
Basalt	SR n/a SRI n/a	✓
Burgundy Red	SR .35 SRI 38	✓
Burnt Clay	SR .36 SRI 40	✓
Old Oak	SR .37 SRI 41	✓
Steel Blue	SR n/a SRI n/a	✓

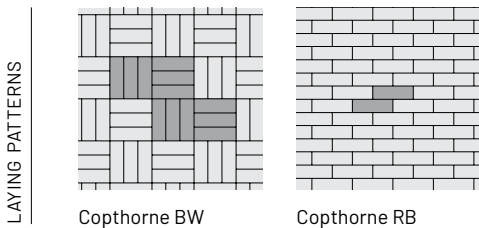

BURGUNDY RED      BURNT CLAY      OLD OAK      3 COLOR BLEND  
Blended on Site



ARCTIC GREY      STEEL BLUE      BASALT      3 COLOR GREY BLEND  
Blended on Site

SINGLE UNIT

**STANDARD**  
65 x 200 x 60mm  
2 5/8 x 7 7/8 x 2 3/8"  
600 Units/Bundle  
.15 SqFt/Stone

Notes: SOLD IN FULL BUNDLES ONLY and is produced and sold on a required, refundable skid. Important: A urethane rubber paver mat must be used to prevent scuffing when compacting. All measurements are nominal. Contact Unilock for more information.



## APPLICATIONS

Pedestrian, Light Vehicular, Border/Accents

## APPEARANCE

Edge Detail - Rounded

Surface Texture - Textured

Joint Spacing - 15 mm

## TECHNICAL INFORMATION

Conforms to ASTM C 936

Eligible for LEED v4.1 credits

Bundle Type	RANDOM
Plant Produced	AYR
Thickness (mm)	60 mm

SQFT PER	Stone	-
	Layer	12.29
	Bundle	98.30

PER BUNDLE	Layers	8.00
------------	--------	------

SOLDIER LNFT PER	SqFt	-
	Layer	-
	Bundle	-

SAILOR LNFT PER	SqFt	2.25
	Layer	27.69
	Bundle	221.52

UNITS PER	SqFt	-
	Layer	48.00
	Bundle	384.00

LBS PER	Unit	-
	Layer	291
	Bundle	2,326

Colors	Reflectance	Stock
Basalt	SR n/a SRI n/a	✓
Belgian Blue	SR n/a SRI n/a	SO
Dawn Mist	SR n/a SRI n/a	SO
Pebble Taupe	SR n/a SRI n/a	SO

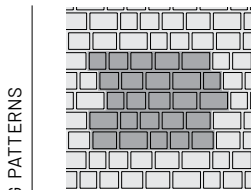

LAYING PATTERNS

Courtstone Fixed Random A

5 UNIT RANDOM BUNDLE

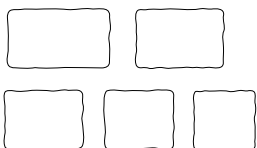

**XL RECTANGLE**  
215 x 130 x 60mm  
8 3/8 x 5 1/8 x 2 3/8"  
128 Units/Bundle  
.30 SqFt/Stone

**LARGE RECTANGLE**  
185 x 130 x 60mm  
7 1/4 x 5 1/8 x 2 3/8"  
64 Units/Bundle  
.28 SqFt/Stone

**RECTANGLE**  
165 x 130 x 60mm  
6 1/2 x 5 1/8 x 2 3/8"  
64 Units/Bundle  
.23 SqFt/Stone

**SMALL RECTANGLE**  
145 x 130 x 60mm  
5 3/4 x 5 1/8 x 2 3/8"  
64 Units/Bundle  
.20 SqFt/Stone

**SQUARE**  
130 x 130 x 60mm  
5 1/8 x 5 1/8 x 2 3/8"  
64 Units/Bundle  
.18 SqFt/Stone



**Notes: Special Order (SO).** Minimum quantities apply. **Lead time required.** **SOLD IN FULL BUNDLES ONLY** and is produced and sold on a required, refundable skid. **Important: A urethane rubber paver mat must be used to prevent scuffing when compacting.** All measurements are nominal. Contact Unilock for more information.



**APPLICATIONS**

Pedestrian, Light Vehicular, Permeable

**APPEARANCE**

Edge Detail Umbriano - Rounded  
 Surface Texture - Umbriano Mottled  
 Joint Spacing - 7 mm

**TECHNICAL INFORMATION**

Conforms to ASTM C 936  
 Eligible for LEED v4.1

	8 x 8
Bundle Type	SINGLE
Plant Produced	GEORGETOWN
Thickness (mm)	60 mm

SQFT PER	Stone	0.45
	Layer	10.83
	Bundle	97.48

PER BUNDLE	Layers	9.00
------------	--------	------

SOLDIER LNFT PER	SqFt	-
	Layer	-
	Bundle	-

SAILOR LNFT PER	SqFt	-
	Layer	-
	Bundle	-

UNITS PER	SqFt	2.22
	Layer	24.00
	Bundle	216.00

LBS PER	Unit	12
	Layer	276
	Bundle	2,486

Colors	Reflectance	Stock
French Grey	SR .18 SRI 17	SO
Midnight Sky	SR .17 SRI 15	SO
Winter Marvel	SR .35 SRI 38	SO

LAYER CONFIGURATION

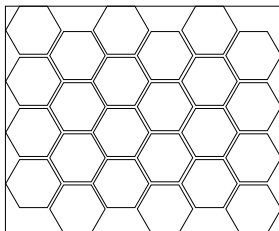

LAYING PATTERNS

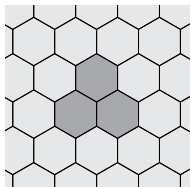

Hex Paver A

SINGLE UNIT

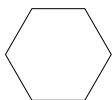

200 x 200 x 60mm  
 7 7/8 x 7 7/8 x 2 3/8"  
 216 Units/Bundle  
 .45 SqFt/Stone

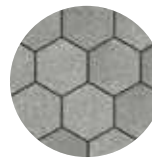

FRENCH GREY



MIDNIGHT SKY



WINTER MARVEL

**Notes: Special Order (SO).** Minimum quantities apply. **Lead time required.** **SOLD IN FULL BUNDLES ONLY** and is produced and sold on a required, refundable skid. **Important: A urethane rubber paver mat must be used to prevent scuffing when compacting.** All measurements are nominal. Contact Unilock for more information.



## APPLICATIONS

Pedestrian, Light Vehicular, Roadway Street,  
Heavy-duty, Permeable

## APPEARANCE

Edge Detail - Micro  
Surface Texture - Smooth  
Joint Spacing - 7mm  
Void - 4.6-7.08%

## TECHNICAL INFORMATION

Conforms to ASTM C 936  
Eligible for LEED v4.1 credits

	5 x 10
Bundle Type	SINGLE
Plant Produced	MICHIGAN
Thickness (mm)	80 mm

SQFT PER	Stone	0.31
	Layer	10.85
	Bundle	75.95

PER BUNDLE	Layers	7.00
------------	--------	------

SOLDIER LNFT PER	SqFt	1.27
	Layer	13.78
	Bundle	96.46

SAILOR LNFT PER	SqFt	2.54
	Layer	27.56
	Bundle	192.91

UNITS PER	SqFt	3.23
	Layer	35.00
	Bundle	245.00

LBS PER	Unit	11
	Layer	397
	Bundle	2,778

Colors	Reflectance	Stock
Beechwood	SR .n/a SRI n/a	✓

LAYER CONFIGURATION

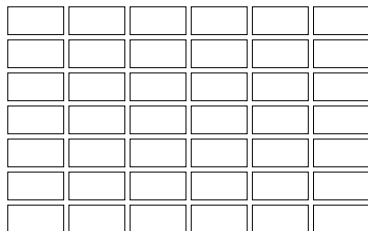

LAYING PATTERNS

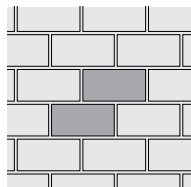

EcoPriora 5x10 RB

SINGLE UNITS



**5 x 10**  
120 x 240 x 80mm  
4 ¾ x 9 ½ x 3 ⅛  
245 Units/Bundle  
.31 Sq.Ft./Stone

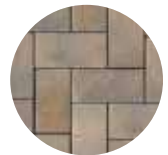

BEECHWOOD

**Notes: SOLD IN FULL BUNDLES ONLY. Important:** A urethane rubber paver mat must be used to prevent scuffing when compacting on textured surfaces. All measurements are nominal. Contact Unilock for more information.



### APPLICATIONS

Pedestrian, Light Vehicular, Roadway Street,  
Heavy-duty, Permeable

### APPEARANCE

Edge Detail - Micro  
Surface Texture - Smooth  
Joint Spacing - 7mm  
Void - 4.6-7.08%

### TECHNICAL INFORMATION

Conforms to ASTM C 936  
Eligible for LEED v4.1 credits

	5 x 10
Bundle Type	SINGLE
Plant Produced	MICHIGAN
Thickness (mm)	80 mm

SQFT PER	Stone	0.31
	Layer	10.85
	Bundle	75.95

PER BUNDLE	Layers	7.00
------------	--------	------

SOLDIER LNFT PER	SqFt	1.27
	Layer	13.78
	Bundle	96.46

SAILOR LNFT PER	SqFt	2.54
	Layer	27.56
	Bundle	192.91

UNITS PER	SqFt	3.23
	Layer	35.00
	Bundle	245.00

LBS PER	Unit	11
	Layer	397
	Bundle	2,778

Colors	Reflectance	Stock
Fossil	SR .n/a SRI n/a	✓
Granite	SR .26 SRI 27	✓

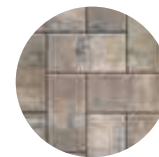

FOSSIL



GRANITE

LAYING PATTERNS

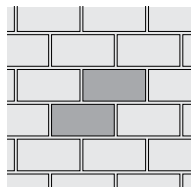

EcoPriora 5x10 RB

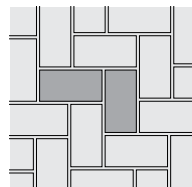

EcoPriora 5x10 HB

SINGLE UNITS



**5 x 10**  
120 x 240 x 80mm  
4 ¾ x 9 ½ x 3 ⅛  
245 Units/Bundle  
.31 Sq.Ft./Stone

Notes: SOLD IN FULL BUNDLES ONLY. Important: A urethane rubber paver mat must be used to prevent scuffing when compacting on textured surfaces. All measurements are nominal. Contact Unilock for more information.



**APPLICATIONS**

Pedestrian, Light Vehicular

**APPEARANCE**

Edge Detail - Rounded  
 Surface Texture - Shot Blasted  
 Joint Spacing - 7 mm  
 Void - 8.6%

**TECHNICAL INFORMATION**

Conforms to ASTM C 936  
 Eligible for LEED v4.1 credits

	4 x 12
Bundle Type	SINGLE
Plant Produced	ONTARIO
Thickness (mm)	80 mm

SQFT PER	Stone	0.32
	Layer	11.63
	Bundle	81.38

PER BUNDLE	Layers	7.00
------------	--------	------

SOLDIER LNFT PER	SqFt	1.02
	Layer	11.81
	Bundle	82.68

SAILOR LNFT PER	SqFt	3.05
	Layer	35.43
	Bundle	248.03

UNITS PER	SqFt	3.10
	Layer	36.00
	Bundle	252.00

LBS PER	Unit	12
	Layer	425
	Bundle	2,978

Colors	Reflectance	Stock
Light Opal Blend	SR n/a SRI n/a	SO
Light Steel Grey	SR n/a SRI n/a	SO

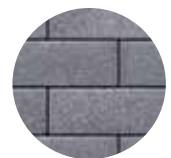
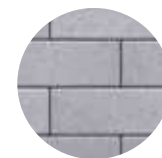

LIGHT OPAL BLEND

LIGHT STEEL GREY

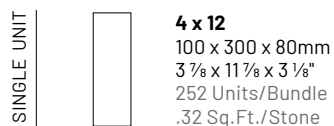
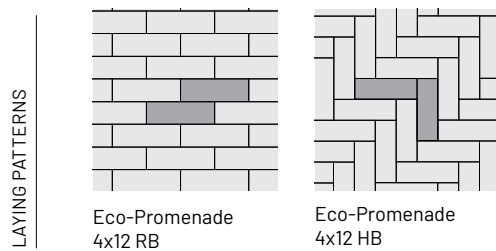

Notes: Special Order (SO). Minimum quantities apply. Lead time required. SOLD IN FULL BUNDLES ONLY and is produced and sold on a required, refundable skid. Important: A urethane rubber paver mat must be used to prevent scuffing when compacting on textured surfaces. All measurements are nominal. Contact Unilock for more information.



## APPLICATIONS

Pedestrian, Light Vehicular, Permeable

## APPEARANCE

Edge Detail - Micro

Surface Texture - Series

Joint Spacing - 7 mm

## TECHNICAL INFORMATION

Conforms to ASTM C 936

Eligible for LEED v4.1 credits

	4 x 12
Bundle Type	SINGLE
Plant Produced	CHICAGO
Thickness (mm)	80 mm

SQFT PER	Stone	0.32
	Layer	11.63
	Bundle	93.04

PER BUNDLE	Layers	8.00
------------	--------	------

SOLDIER LNFT PER	SqFt	1.02
	Layer	11.81
	Bundle	94.49

SAILOR LNFT PER	SqFt	3.05
	Layer	35.43
	Bundle	283.46

UNITS PER	SqFt	3.10
	Layer	36.00
	Bundle	288.00

LBS PER	Unit	12
	Layer	426
	Bundle	3,404

Colors	Reflectance	Stock
Arctic Grey	SR n/a SRI n/a	SO
Nordic Star	SR n/a SRI n/a	SO

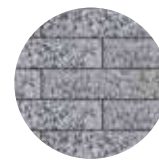

ARCTIC GREY

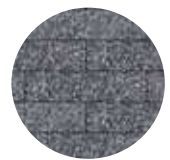

NORDIC STAR

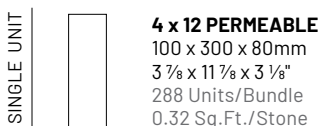
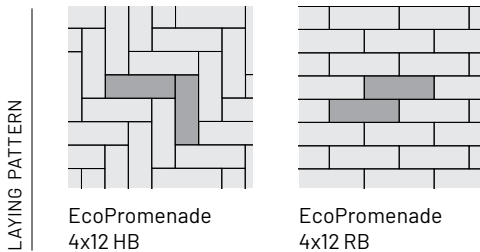

**Notes: Special Order (SO).** Minimum quantities apply. **Lead time required. SOLD IN FULL BUNDLES ONLY.** Important: A urethane rubber paver mat must be used to prevent scuffing when compacting on textured surfaces. All measurements are nominal. Contact Unilock for more information.



## APPLICATIONS

Pedestrian, Light Vehicular, Permeable

## APPEARANCE

Edge Detail - Micro

Surface Texture - Umbriano

Joint Spacing - 7 mm

## TECHNICAL INFORMATION

Conforms to ASTM C 936

Eligible for LEED v4.1 credits

		4 x 12
	Bundle Type	SINGLE
	Plant Produced	MARENGO
	Thickness (mm)	80 mm

SQFT PER	Stone	0.32
	Layer	11.63
	Bundle	93.04

PER BUNDLE	Layers	8.00
------------	--------	------

SOLDIER LNFT PER	SqFt	1.02
	Layer	11.81
	Bundle	94.49

SAILOR LNFT PER	SqFt	3.05
	Layer	35.43
	Bundle	283.46

UNITS PER	SqFt	3.10
	Layer	36.00
	Bundle	288.00

LBS PER	Unit	12
	Layer	426
	Bundle	3,404

Colors	Reflectance	Stock
French Grey	SR .n/a SRI n/a	SO
Midnight Sky	SR .n/a SRI n/a	SO
Winter Marvel	SR .n/a SRI n/a	SO



FRENCH GREY



MIDNIGHT SKY



WINTER MARVEL

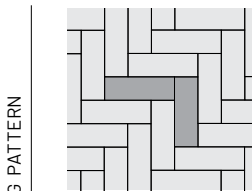

EcoPromenade  
4x12 HB

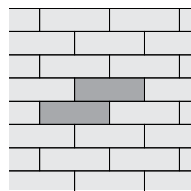

EcoPromenade  
4x12 RB

SINGLE UNIT



**4 x 12**  
100 x 300 x 80mm  
3<sup>7</sup>/<sub>8</sub> x 11<sup>7</sup>/<sub>8</sub> x 3<sup>1</sup>/<sub>8</sub>"  
288 Units/Bundle  
0.32Sq.Ft./Stone

**Notes: Special Order (SO).** Minimum quantities apply. **Lead time required.** **SOLD IN FULL BUNDLES ONLY** and is produced and sold on a required, refundable skid. **Important: A urethane rubber paver mat must be used to prevent scuffing when compacting on textured surfaces.** All measurements are nominal. Contact Unilock for more information.



**APPLICATIONS**

Pedestrian, Light Vehicular

**APPEARANCE**

Edge Detail - Micro  
 Surface Texture - Smooth  
 Joint Spacing - 3 mm

**TECHNICAL INFORMATION**

Conforms to ASTM C 936  
 Eligible for LEED v4.1 credits

	8 x 8
Bundle Type	SINGLE
Plant Produced	MICHIGAN
Thickness (mm)	70 mm

SQFT PER	Stone	0.39
	Layer	9.24
	Bundle	73.92

PER BUNDLE	Layers	8.00
------------	--------	------

SOLDIER LNFT PER	SqFt	-
	Layer	-
	Bundle	-

SAILOR LNFT PER	SqFt	-
	Layer	-
	Bundle	-

UNITS PER	SqFt	2.60
	Layer	24.00
	Bundle	192.00

LBS PER	Unit	13
	Layer	306
	Bundle	2,450

Colors	Reflectance	Stock
Dark Charcoal	SR .n/a SRI n/a	✓
Granite Fusion	SR .n/a SRI n/a	✓

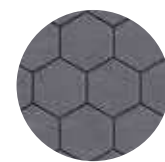

DARK CHARCOAL

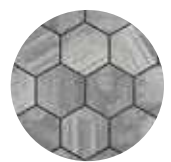

GRANITE FUSION

LAYER CONFIGURATION

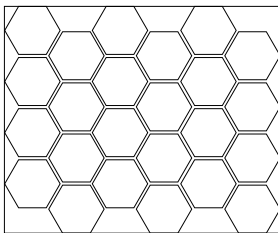

LAYING PATTERNS

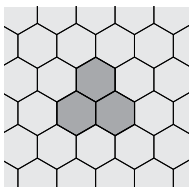

Hex Paver A

SINGLE UNIT

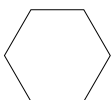

**8 x 8**  
 200 x 200 x 70mm  
 7 7/8 x 7 7/8 x 2 3/4"  
 192 Units/Bundle  
 .39 Sq.Ft./Stone

Notes: SOLD IN FULL BUNDLES ONLY and is produced and sold on a refundable skid. Important: A urethane rubber paver mat must be used to prevent scuffing when compacting. All measurements are nominal. Contact Unilock for more information.



## APPLICATIONS

Pedestrian, Light Vehicular, Borders and accents

## APPEARANCE

Edge Detail - Chamfer

Surface Texture - Smooth

Joint Spacing - 3 mm

## TECHNICAL INFORMATION

Conforms to ASTM C 936

Eligible for LEED v4.1 credits

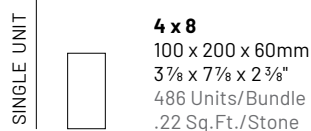
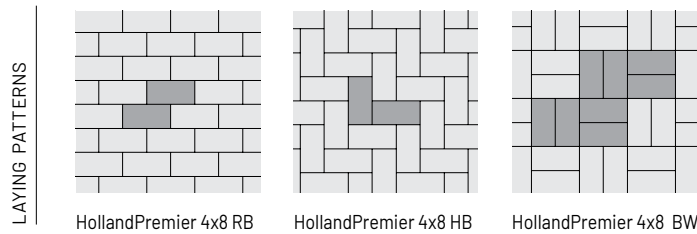
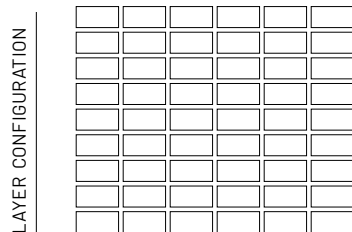

	4 x 8
Bundle Type	SINGLE
Plant Produced	MICHIGAN
Thickness (mm)	60 mm

SQFT PER	Stone	0.22
	Layer	11.80
	Bundle	106.20

PER BUNDLE	Layers	9.00
------------	--------	------

SOLDIER LNFT PER	SqFt	1.50
	Layer	17.72
	Bundle	159.45

SAILOR LNFT PER	SqFt	3.00
	Layer	35.43
	Bundle	318.90

UNITS PER	SqFt	4.58
	Layer	54.00
	Bundle	486.00

LBS PER	Unit	6
	Layer	324
	Bundle	2,914

Colors	Reflectance	Stock
Dark Charcoal	SR n/a SRI n/a	✓
Charleston	SR n/a SRI n/a	✓
Fossil	SR .22 SRI 21	✓
Granite Fusion	SR n/a SRI n/a	✓
Indiana Buff	SR n/a SRI n/a	✓



Notes: **SOLD IN FULL BUNDLES ONLY.** Important: A urethane rubber paver mat must be used to prevent scuffing when compacting on textured surfaces. All measurements are nominal. Contact Unilock for more information.

# Hollandstone™



## APPLICATIONS

Pedestrian, Light Vehicular  
80mm only: Roadway Street, Heavy-duty

## APPEARANCE

Edge Detail - Chamfer  
Surface Texture - Smooth  
Joint Spacing - 3 mm

## TECHNICAL INFORMATION

Conforms to ASTM C 936  
Eligible for LEED v4.1 credits

	4 x 8	4 x 8
Bundle Type	SINGLE	SINGLE
Plant Produced	MICHIGAN	MICHIGAN
Thickness (mm)	60 mm	80 mm

SQFT PER	Stone	0.22	0.22
	Layer	11.80	11.80
	Bundle	106.20	82.60

PER BUNDLE	Layers	9.00	7.00
------------	--------	------	------

SOLDIER LNFT PER	SqFt	1.50	1.50
	Layer	17.72	17.71
	Bundle	159.45	124.00

SAILOR LNFT PER	SqFt	3.00	-
	Layer	35.43	-
	Bundle	318.90	-

UNITS PER	SqFt	4.58	4.58
	Layer	54.00	54.00
	Bundle	486.00	378.00

LBS PER	Unit	6	8
	Layer	324	426
	Bundle	2,914	2,985

Colors	Reflectance	Stock	Stock
Beechwood	SR n/a SRI n/a	✓	SO
Rustic Red	SR n/a SRI n/a	✓	SO
Terra Cotta	SR n/a SRI n/a	✓	SO

LAYER CONFIGURATION

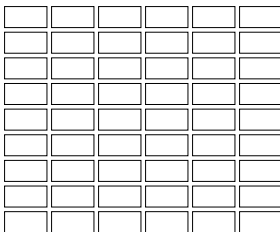

LAYING PATTERNS

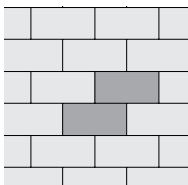

Hollandstone 4x8 RB

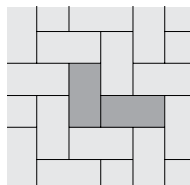

Hollandstone 4x8 HB

SINGLE UNIT



**4 x 8**  
100 x 200 x 60mm  
3 7/8 x 7 7/8 x 2 3/8"  
486 Units/Bundle  
.22 Sq.Ft./Stone

**4 x 8**  
100 x 200 x 80mm  
3 7/8 x 7 7/8 x 3 1/8"  
378 Units/Bundle  
.22 Sq.Ft./Stone



BEECHWOOD

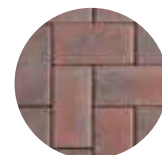

RUSTIC RED



TERRA COTTA

Notes: Special Order (SO) 80mm only. Minimum quantities apply. Lead time required. SOLD IN FULL BUNDLES ONLY. Important: A urethane rubber paver mat must be used to prevent scuffing when compacting on textured surfaces. All measurements are nominal. Contact Unilock for more information.



## APPLICATIONS

Pedestrian, Light Vehicular, Roadway Street, Border/Accents

## APPEARANCE

Edge Detail - Rounded  
Surface Texture - Il Campo® Brushed  
Joint Spacing - 3 mm

## TECHNICAL INFORMATION

Conforms to ASTM C 936  
Eligible for LEED v4.1 credits

	4 x 8 BRUSHED
Bundle Type	SINGLE
Plant Produced	AYR
Thickness (mm)	70 mm

SQFT PER	Stone	0.22
	Layer	11.80
	Bundle	94.40

PER BUNDLE	Layers	8.00
------------	--------	------

SOLDIER LNFT PER	SqFt	1.50
	Layer	17.72
	Bundle	141.73

SAILOR LNFT PER	SqFt	3.00
	Layer	35.43
	Bundle	283.46

UNITS PER	SqFt	4.58
	Layer	54.00
	Bundle	432.00

LBS PER	Unit	7
	Layer	377
	Bundle	3,014

Colors	Reflectance	Stock
Dark Charcoal	SR n/a SRI n/a	✓



DARK CHARCOAL

LAYING PATTERNS

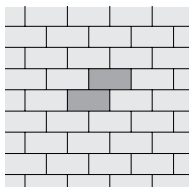

Il Campo 4x8 RB

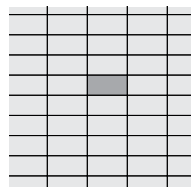

Il Campo 4x8 SB

SINGLE UNIT



**4 x 8**  
100 x 200 x 70mm  
3 7/8 x 7 7/8 x 2 3/4"  
432 Units/Bundle  
.22 Sq.Ft./Stone

Notes: **SOLD IN FULL BUNDLES ONLY** and is produced and sold on a required, refundable skid. **Important:** A urethane rubber paver mat must be used to prevent scuffing when compacting. All measurements are nominal. Contact Unilock for more information.



## APPLICATIONS

Pedestrian, Light Vehicular, Border/Accents

## APPEARANCE

Edge Detail - Zero

Surface Texture - Timeworn

Joint Spacing - 4 mm

## TECHNICAL INFORMATION

Conforms to ASTM C 936

Eligible for LEED v4.1 credits

	STANDARD SMOOTH
Bundle Type	SINGLE
Plant Produced	AURORA
Thickness (mm)	60 mm

SQFT PER	Stone	0.16
	Layer	11.16
	Bundle	111.60

PER BUNDLE	Layers	10.00
------------	--------	-------

SOLDIER LNFT PER	SqFt	1.27
	Layer	14.17
	Bundle	141.73

SAILOR LNFT PER	SqFt	5.08
	Layer	56.69
	Bundle	566.93

UNITS PER	SqFt	6.45
	Layer	-
	Bundle	720.00

LBS PER	Unit	-
	Layer	306
	Bundle	3,063

Colors	Reflectance	Stock
Cocoa Brown	SR n/a SRI n/a	✓
Dark Charcoal	SR n/a SRI n/a	✓
Granite Fusion	SR n/a SRI n/a	✓
Sable Blend	SR n/a SRI n/a	✓

LAYER CONFIGURATION

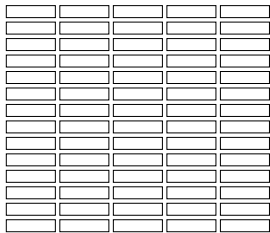

LAYING PATTERNS

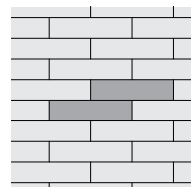
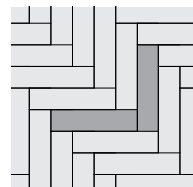
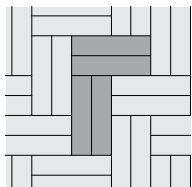

Mattoni DHB

Mattoni HB

Mattoni RB

SINGLE UNIT



**STANDARD**  
60 x 240 x 60mm  
2 3/8 x 9 1/2 x 2 3/8"  
720 Units/Bundle  
.16 Sq.Ft./Stone

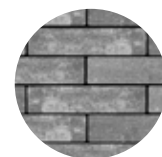

GRANITE FUSION



SABLE BLEND



COCOA BROWN



DARK CHARCOAL

# Natural Stone Slabs



## APPLICATIONS

Pedestrian, Roof Deck

## APPEARANCE

Edge Detail - Sawn

Surface Texture - Brushed / Riven

Joint Spacing - 10 mm

## TECHNICAL INFORMATION

Visit [Unilock.com](http://Unilock.com) for more information.

SANDSTONE	12 x 24	18 x 24	24 x 24	24 x 36
Bundle Type	SINGLE	SINGLE	SINGLE	SINGLE
Thickness (mm)	22 mm	22 mm	22 mm	22 mm

SQFT PER	Crate	180.00	186.00	160.00	180.00
	Units	2.00	3.00	4.00	6.00

UNITS PER	Crate	90.00	62.00	40.00	30.00
	SqFt	0.50	0.33	0.25	0.17

LBS PER	Unit	24	36	48	72
	Crate	2,033	2,136	1,836	2,072

Colors	Reflectance	Stock	Stock	Stock	Stock
Cascade	SR n/a SRI n/a	✓	✓	✓	✓
Greyfield	SR .32 SRI 35	✓	✓	✓	✓
Stone Cliff Grey	SR .27 SRI 28	✓	✓	✓	✓

LIMESTONE	12 x 24	18 x 24	24 x 24	24 x 36
Bundle Type	SINGLE	SINGLE	SINGLE	SINGLE
Thickness (mm)	22 mm	22 mm	22 mm	22 mm

SQFT PER	Crate	180.00	186.00	160.00	180.00
	Units	2.00	3.00	4.00	6.00

UNITS PER	Crate	90.00	62.00	40.00	30.00
	SqFt	0.50	0.33	0.25	0.17

LBS PER	Unit	24	36	48	72
	Crate	2,033	2,136	1,836	2,072

Colors	Reflectance	Stock	Stock	Stock	Stock
Black River	SR .08 SRI 4	✓	✓	✓	✓
Hearthstone	SR .20 SRI 20	✓	✓	✓	✓

LAYING PATTERNS

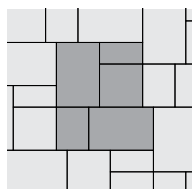

NaturalStone Multi-Unit

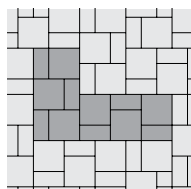

NaturalStone Multi-Unit

SINGLE UNITS

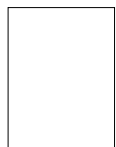

**12 x 24**  
290 x 590 x 22mm  
11 1/2 x 23 1/4 x 7/8"

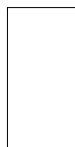

**18 x 24**  
440 x 590 x 22mm  
17 3/8 x 23 1/4 x 7/8"



**24 x 36**  
590 x 890 x 22mm  
23 1/4 x 35 x 7/8"

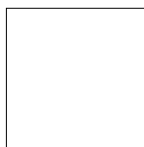

**24 x 24**  
590 x 590 x 22mm  
23 1/4 x 23 1/4 x 7/8"



CASCADE

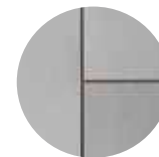

GREYFIELD



STONE CLIFF GREY



BLACK RIVER



HEARTHSTONE

Notes: **SOLD IN FULL CRATES ONLY** and all units except the 24x24" require a refundable skid. This product is not intended for vehicular applications. All measurements are nominal. Contact Unilock for more information.

# Natural Stone Random Bundle



## APPLICATIONS

Pedestrian

## APPEARANCE

Edge Detail - Sawn

Surface Texture - Natural Finish

Joint Spacing - 10 mm

## TECHNICAL INFORMATION

Visit [Unilock.com](http://Unilock.com) for more information.

LAYING PATTERNS

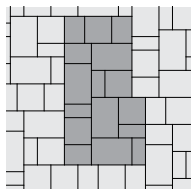

NaturalStone Fixed RB

4 UNIT RANDOM

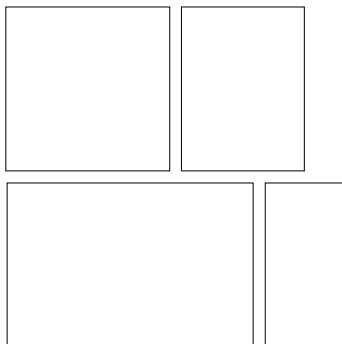

**24 x 24**  
590 x 590 x 38mm  
23 1/4 x 23 1/4 x 1 1/2"

**18 x 24**  
440 x 590 x 38mm  
17 3/8 x 23 1/4 x 1 1/2"

**24 x 36**  
590 x 890 x 38mm  
23 1/4 x 35 x 1 1/2"

**12 x 24**  
290 x 590 x 38mm  
11 1/2 x 23 1/4 x 1 1/2"

SANDSTONE		4 PC BUNDLE
Bundle Type		RANDOM
Thickness (mm)		38 mm
SQFT PER	Crate	120.00
	Units	-
UNITS PER	Crate	32.00
	SqFt	-
LBS PER	Unit	73
	Bundle	2,515
Colors	Reflectance	Stock
Stone Cliff Grey	SR .27 SRI 28	<b>SO</b>

LIMESTONE		4 PC BUNDLE
Bundle Type		RANDOM
Thickness (mm)		38 mm
SQFT PER	Crate	120.00
	Units	-
UNITS PER	Crate	32
	SqFt	-
LBS PER	Unit	73
	Bundle	2,315
Colors	Reflectance	Stock
Hearthstone	SR n/a SRI n/a	<b>SO</b>



STONE CLIFF GREY



HEARTHSTONE

Notes: **Special Order (SO)**. Minimum quantities apply. **Lead time required**. **SOLD IN FULL CRATES ONLY**. This project pack must be installed with a 10 mm joint space between stones. This product is not intended for vehicular applications. All measurements are nominal. Contact Unilock for more information.

# Natural Stone Coping



## APPLICATIONS

Wall Coping, Pool Coping, Steps Treads



CASCADE



GREYFIELD



STONE CLIFF GREY



BLACK RIVER

SANDSTONE		48 X 12 FULLNOSE COPING	48 X 12 STRAIGHT EDGE COPING	48 X 12 ROCKFACE COPING	48 X 14 FULLNOSE COPING	48 X 14 STRAIGHT COPING	48 X 14 ROCKFACE COPING
	Bundle Type		SINGLE	SINGLE	SINGLE	SINGLE	SINGLE
Thickness (mm)		50 mm	50 mm	50 mm	50 mm	50 mm	50 mm

UNITS PER							
	Crate		20.00	20.00	20.00	20.00	20.00
SqFt		4.00	4.00	4.00	4.67	4.67	4.67

LBS PER							
	Unit		101	97	106	117	117
Crate		2,028	1,927	2,116	2,560	2,247	2,258

Colors	Reflectance	Stock	Stock	Stock	Stock	Stock	Stock
Cascade	SR n/a SRI n/a	✓	✓	✓	✓	✓	✓
Greyfield	SR n/a SRI n/a	✓	✓	✓	✓	✓	✓
Stone Cliff Grey	SR n/a SRI n/a	✓	✓	✓	✓	✓	✓

LIMESTONE		48 X 12 FULLNOSE COPING	48 X 12 STRAIGHT EDGE COPING	48 X 12 ROCKFACE COPING	48 X 14 FULLNOSE COPING	48 X 14 STRAIGHT COPING	48 X 14 ROCKFACE COPING
	Bundle Type		SINGLE	SINGLE	SINGLE	SINGLE	SINGLE
Thickness (mm)		50 mm	50 mm	50 mm	50 mm	50 mm	50 mm

UNITS PER							
	Crate		20.00	20.00	20.00	20.00	20.00
SqFt		4.00	4.00	4.00	4.67	4.67	4.67

LBS PER							
	Unit		112	112	112	130	130
Crate		2,222	2,222	2,222	2,593	2,593	2,593

Colors	Reflectance	Stock	Stock	Stock	Stock	Stock	Stock
Black River	SR n/a SRI n/a	✓	✓	✓	✓	✓	✓

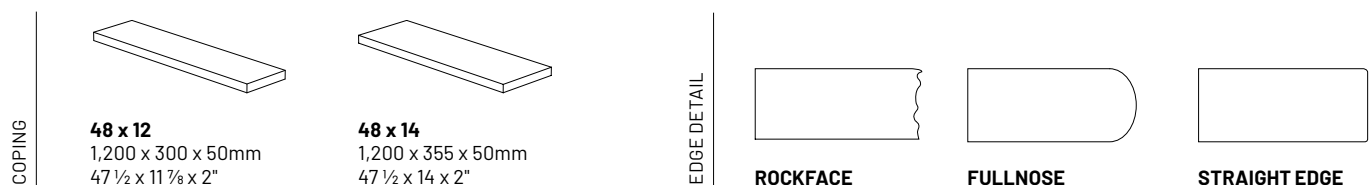

Notes: SOLD IN FULL CRATES ONLY. Steps, Coping & Pillar Caps require a refundable skid. This product is not intended for vehicular applications. All measurements are nominal. Contact Unilock for more information.

# Natural Stone Coping



## APPLICATIONS

Wall Coping, Pool Coping, Steps Treads



CASCADE



GREYFIELD



STONE CLIFF GREY



BLACK RIVER

SANDSTONE		28 X 14 FULLNOSE CORNER / COPING	28 X 14 STRAIGHT CORNER / COPING	24 X 12 FULLNOSE CORNER / COPING	24 X 12 STRAIGHT CORNER / COPING	24 X 24 INSERT COPING
Bundle Type		SINGLE	SINGLE	SINGLE	SINGLE	SINGLE
Thickness (mm)		50 mm	50 mm	50 mm	50 mm	50 mm

UNITS PER	Crate	20.00	20.00	20.00	20.00	20.00
	SqFt	4.67	4.67	3.0	3.0	4.67

LBS PER	Unit	113	113	91	91	106
	Crate	2,249	2,249	1,808	1,808	2,120

Colors	Reflectance	Stock	Stock	Stock	Stock	Stock
Cascade	SR n/a SRI n/a	SO	SO	SO	SO	SO
Greyfield	SR n/a SRI n/a	SO	SO	SO	SO	SO
Stone Cliff Grey	SR n/a SRI n/a	SO	SO	SO	SO	SO

LIMESTONE		28 X 14 FULLNOSE CORNER / COPING	28 X 14 STRAIGHT CORNER / COPING	24 X 12 FULLNOSE CORNER / COPING	24 X 12 STRAIGHT CORNER / COPING	24 X 24 INSERT COPING
Bundle Type		SINGLE	SINGLE	SINGLE	SINGLE	SINGLE
Thickness (mm)		50 mm	50 mm	50 mm	50 mm	50 mm

UNITS PER	Crate	20.00	20.00	20.00	20.00	20.00
	SqFt	4.08	4.08	3.0	3.0	4.0

LBS PER	Unit	117	117	84	84	90
	Crate	2,237	2,237	1,676	1,676	1,800

Colors	Reflectance	Stock	Stock	Stock	Stock	Stock
Black River	SR n/a SRI n/a	SO	SO	SO	SO	SO

INSERT COPING

Insert coping is ideal for those retractable pool covers. Allowing easy access while keeping a continuous look and feel.

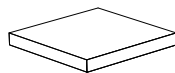

**24 x 24**  
600 x 600 x 50mm  
24 x 24 x 2"

CORNER COPING

Corner coping provides seamless 90° corners for pool, walls and so much more.

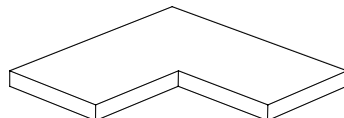

**28 x 14**  
710 x 355 x 50mm  
28 x 14 x 2"

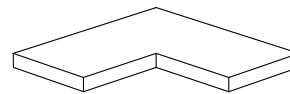

**24 x 12**  
600 x 300 x 50mm  
23 5/8 x 11 7/8 x 2"

EDGE DETAIL



**STRAIGHT EDGE**



**FULLNOSE**

**Notes: Special Order (SO).** Minimum quantities apply. **Lead time required.** Steps, Coping & Pillar Caps require a refundable skid. This product is not intended for vehicular applications. All measurements are nominal. Contact Unilock for more information.

# Natural Stone Steps & Pillar Caps



## APPLICATIONS

Steps, Pillar

## TECHNICAL INFORMATION

Visit [Unilock.com](http://Unilock.com) for more information.

SANDSTONE		24 X 24 PILLAR CAP	28 X 28 PILLAR CAP	48 X 16 STEP
Bundle Type		SINGLE	SINGLE	SINGLE
Thickness (mm)		64 mm	64 mm	150 mm
LNFT PER	Crate	28.00	28.00	24.00
	Unit	2.33	2.33	4.00
UNITS PER	Crate	14.00	12.00	6.00
LBS PER	Unit	143	199	421
	Crate	1,991	2,385	2,526
Colors	Reflectance	Stock	Stock	Stock
Cascade	SR n/a SRI n/a	✓	✓	✓
Greyfield	SR n/a SRI n/a	✓	✓	✓
Stone Cliff Grey	SR n/a SRI n/a	✓	✓	✓

LIMESTONE		24 X 24 PILLAR CAP	28 X 28 PILLAR CAP	48 X 16 STEP
Bundle Type		SINGLE	SINGLE	SINGLE
Thickness (mm)		64 mm	64 mm	150 mm
LNFT PER	Crate	28.00	28.00	24.00
	Unit	2.33	2.33	4.00
UNITS PER	Crate	14.00	12.00	6.00
LBS PER	Unit	143	207	421
	Crate	1,995	2,480	2,526
Colors	Reflectance	Stock	Stock	Stock
Black River	SR n/a SRI n/a	✓	✓	✓



CASCADE



GREYFIELD



STONE CLIFF GREY



BLACK RIVER

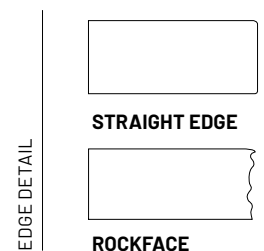
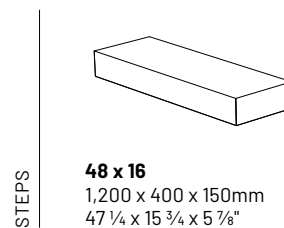
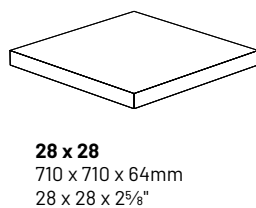
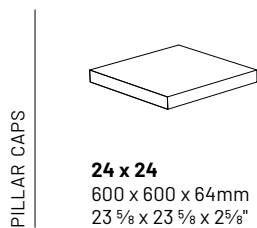

Notes: **SOLD IN FULL CRATES ONLY.** This product is not intended for vehicular applications. All measurements are nominal. Contact Unilock for more information.



## APPLICATIONS

Pedestrian, Light Vehicular, Roadway Street,  
Heavy-duty, Permeable

## APPEARANCE

Edge Detail - Zero  
Surface Texture - Textured  
Void - 8.6%

## TECHNICAL INFORMATION

Conforms to ASTM C 936  
Eligible for LEED v4.1 credits

		STANDARD
Bundle Type		SINGLE
Plant Produced		CHICAGO
Thickness (mm)		60 mm
SQFT PER	Stone	0.09
	Layer	9.83
	Bundle	98.25
PER BUNDLE	Layers	10.00
SOLDIER LNFT PER	SqFt	3.39
	Layer	33.31
	Bundle	333.07
SAILOR LNFT PER	SqFt	-
	Layer	-
	Bundle	-
UNITS PER	SqFt	10.99
	Layer	108.00
	Bundle	1,080.00
LBS PER	Unit	2
	Layer	230
	Bundle	2,301

Colors	Reflectance	Stock
Granite Fusion	SR n/a SRI n/a	✓
Dark Charcoal	SR n/a SRI n/a	✓
Opal Blend	SR n/a SRI n/a	✓

LAYER CONFIGURATION

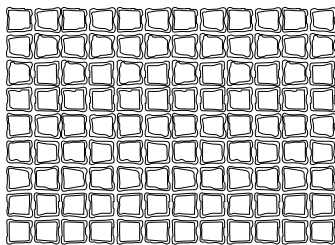

LAYING PATTERNS

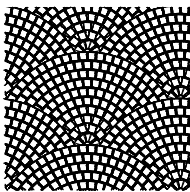

NordicCobble\_Fan

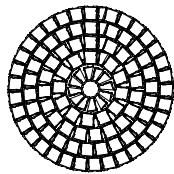

NordicCobble\_Circle

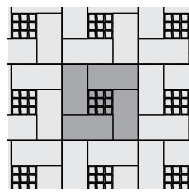

NordicCobble\_A

SINGLE UNITS



**STANDARD**  
89.9 x 94 x 60mm  
3 5/8 x 3 3/4 x 2 3/8"  
1,080 Units/Bundle  
.09 Sq.Ft./Stone



GRANITE FUSION



DARK CHARCOAL



OPAL BLEND

Notes: SOLD IN FULL BUNDLES ONLY and is produced and sold on a required, refundable skid. Important: A urethane rubber paver mat must be used to prevent scuffing when compacting. All measurements are nominal. Contact Unilock for more information.

# 24 x 24 Premier



## APPLICATIONS

Pedestrian, Roof Deck

## APPEARANCE

Surface Texture - Woodgrain & Stone Finish

## TECHNICAL INFORMATION

Visit [Unilock.com](http://Unilock.com) for more information.

	24 x 24
Bundle Type	SINGLE
Plant Produced	HARRISON
Thickness (mm)	50 mm

SQFT PER	Stone	3.88
	Layer	8.00
	Bundle	80.00

PER BUNDLE	Layers	10.00
------------	--------	-------

SOLDIER LNFT PER	SqFt	0.50
	Layer	4.00
	Bundle	40.00

SAILOR LNFT PER	SqFt	-
	Layer	-
	Bundle	-

UNITS PER	SqFt	0.25
	Layer	-
	Bundle	20.00

LBS PER	Unit	-
	Layer	183
	Bundle	1,839

Colors	Reflectance	Stock
Chamois	SR .41 SRI 46	✓
Sterling	SR n/a SRI n/a	✓
Silver Grey	SR n/a SRI n/a	✓
Sandy Beige	SR n/a SRI n/a	✓
Granite	SR n/a SRI n/a	✓
Fossil	SR n/a SRI n/a	✓
Dark Charcoal	SR n/a SRI n/a	✓

SINGLE UNITS

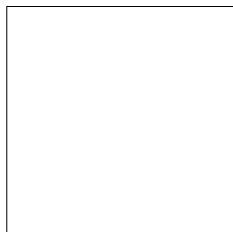

604.8 x 604.8 x 50mm  
 24 x 24 x 2"  
 20 Units/Bundle  
 3.88 Sq.Ft./Stone

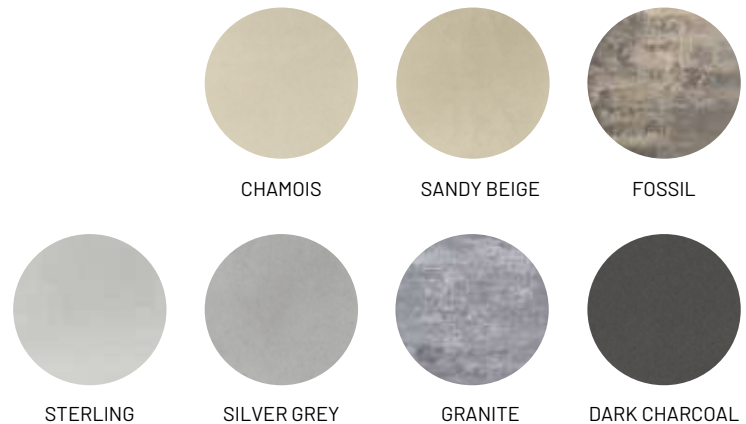

Notes: A urethane rubber paver mat must be used to prevent scuffing when compacting. All measurements are nominal. Contact Unilock for more information.



## APPLICATIONS

Pedestrian, Roof Deck

## TECHNICAL INFORMATION

Visit [Unilock.com](http://Unilock.com) for more information.



		24 x 24 PRESSED EDGE
Bundle Type		SINGLE
Thickness (mm)		20 mm
SQFT PER	Pallet	248.00
	Box	7.75
	Unit	3.88
PER PALLET	Box	32.00
	SqFt	248.00
	Unit	64.00
UNITS PER	Pallet	64.00
	Box	2.00
LBS PER	Unit	36
	SqFt	9
	Box	72
	Pallet	2,289

Colors	Reflectance	Stock
Chamonix Beige	n/a	SO
Chamonix Bianco	n/a	SO
Chamonix Dark Gray	n/a	SO
Chamonix Gray	n/a	SO
Gotham Bianco	n/a	SO
Gotham Gray	n/a	SO
Gotham Nero	n/a	SO
Travstone Beige	n/a	SO
Travstone Gray	n/a	SO
West 57th Bianco	n/a	SO
West 57th Gray	n/a	SO
Essential White	n/a	SO
Essential Gray	n/a	SO
Essential Graphite	n/a	SO
Essential Beige	n/a	SO
Nature Dolomite	n/a	SO
Nature Carrara	n/a	SO
New England White	n/a	SO
New England Ivory	n/a	SO
New England Cold Gray	n/a	SO

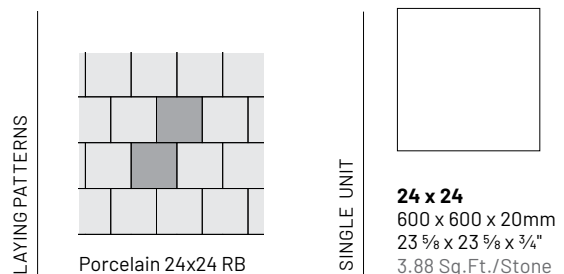

**Notes: Special Order (SO).** Minimum quantities apply. **Lead time required.** **SOLD IN FULL PALLETS ONLY.** **Important:** A urethane rubber paver mat must be used to prevent scuffing when compacting on textured surfaces. All measurements are nominal. Contact Unilock for more information. Porcelain tile is not covered by Unilock's Lifetime Guarantee. Please contact your Territory Manager for more information. **Product is not intended for vehicular applications.**



## APPLICATIONS

Pedestrian, Roof Deck

## TECHNICAL INFORMATION

Visit [Unilock.com](http://Unilock.com) for more information.

	16 x 32 PRESSED EDGE
Bundle Type	SINGLE
Thickness (mm)	20 mm

SQFT PER	Pallet	165.36
	Box	6.89
	Unit	3.45

PER PALLET	Box	24.00
	SqFt	165.36
	Unit	48.00

UNITS PER	Pallet	48.00
	Box	2.00

LBS PER	Unit	32
	SqFt	9
	Box	64
	Pallet	1,538

Colors	Reflectance	Stock
Arbor Bianco	SR n/a SRI n/a	SO
Travstone Beige	SR n/a SRI n/a	SO
Travstone Gray	SR n/a SRI n/a	SO
New England White	SR n/a SRI n/a	SO
New England Ivory	SR n/a SRI n/a	SO
New England Cold Gray	SR n/a SRI n/a	SO
Quartzite Bianco	SR n/a SRI n/a	SO
Quartzite Dark Gray	SR n/a SRI n/a	SO
Quartzite Gray	SR n/a SRI n/a	SO
Quartzite Sand	SR n/a SRI n/a	SO

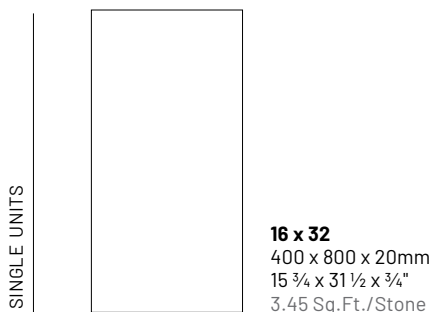
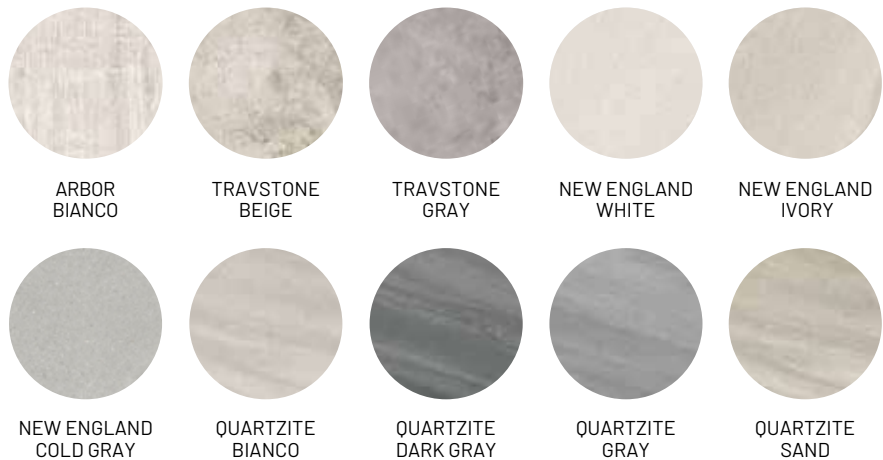
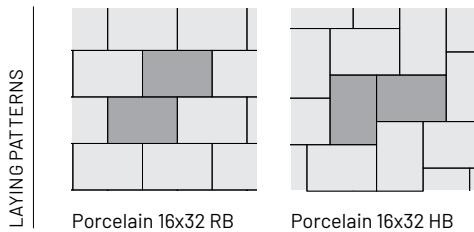

**Notes: Special Order (SO).** Minimum quantities apply. **Lead time required. SOLD IN FULL PALLETES ONLY.** Important: A urethane rubber paver mat must be used to prevent scuffing when compacting on textured surfaces. All measurements are nominal. Contact Unilock for more information. Porcelain tile is not covered by Unilock's Lifetime Guarantee. Please contact your Territory Manager for more information. **Product is not intended for vehicular applications.**



## APPLICATIONS

Pedestrian, Light Vehicular

## APPEARANCE

Edge Detail - Rounded

Surface Texture - Smooth, Series™ Exposed

& Il Campo® Brushed

Joint Spacing - 4 mm

## TECHNICAL INFORMATION

Conforms to ASTM C 936

Eligible for LEED v4.1 credits

	SMOOTH	IL CAMPO	SERIES
Bundle Type	SINGLE	SINGLE	SINGLE
Plant Produced	AYR	AYR	GEORGETOWN
Thickness (mm)	100 mm	100 mm	100 mm

SQFT PER	Stone	0.32	0.32	0.32
	Layer	11.63	11.63	11.63
	Bundle	58.13	58.13	58.13

PER BUNDLE	Layers	5.00	5.00	5.00
------------	--------	------	------	------

SOLDIER LNFT PER	SqFt	1.02	1.02	1.02
	Layer	11.81	11.81	11.81
	Bundle	59.06	59.06	59.06

SAILOR LNFT PER	SqFt	3.05	3.05	3.05
	Layer	35.43	35.43	35.43
	Bundle	177.17	177.17	177.17

UNITS PER	SqFt	3.10	3.10	3.10
	Layer	36.00	36.00	36.00
	Bundle	180.00	180.00	180.00

LBS PER	Unit	15	15	15
	Layer	532	526	532
	Bundle	2,659	2,629	2,659

Colors	Reflectance	Stock	Stock	Stock
Black Granite	SR n/a SRI n/a	-	-	SO
Dark Charcoal	SR n/a SRI n/a	-	SO	-
Granite Fusion	SR n/a SRI n/a	-	SO	-
Light Gray	SR n/a SRI n/a	-	SO	-
Opal Blend	SR .24 SRI 24	SO	-	-
Sandy Beige	SR n/a SRI n/a	SO	-	-
Steel Gray Blend	SR n/a SRI n/a	SO	-	-

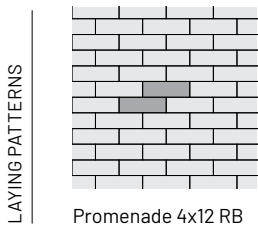

Promenade 4x12 RB

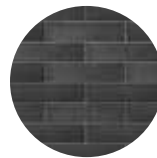

BLACK GRANITE

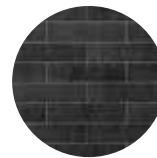

DARK CHARCOAL



GRANITE FUSION



LIGHT GREY



OPAL BLEND



SANDY BEIGE



STEEL GREY BLEND

SINGLE UNITS



**4 x 12 SMOOTH**  
100 x 300 x 100mm  
3 7/8 x 11 7/8 x 3 7/8"  
180 Units/Bundle  
.32 Sq.Ft./Stone

**4 x 12 SERIES**  
100 x 300 x 100mm  
3 7/8 x 11 7/8 x 3 7/8"  
180 Units/Bundle  
.32 Sq.Ft./Stone

**4 x 12 IL CAMPO BRUSHED**  
100 x 300 x 100mm  
3 7/8 x 11 7/8 x 3 7/8"  
180 Units/Bundle  
.32 Sq.Ft./Stone

Notes: Special Order (SO). Minimum quantities apply. Lead time required. SOLD IN FULL BUNDLES ONLY and is produced and sold on a required, refundable skid. Important: A urethane rubber paver mat must be used to prevent scuffing when compacting. All measurements are nominal. Contact Unilock for more information.

# Promenade™ 4x16 - 100mm



## APPLICATIONS

Pedestrian, Light Vehicular

## APPEARANCE

Edge Detail - Rounded

Surface Texture - Smooth

Joint Spacing - 4 mm

## TECHNICAL INFORMATION

Conforms to ASTM C 936

Eligible for LEED v4.1 credits

		SMOOTH	IL CAMPO
	Bundle Type	SINGLE	SINGLE
	Plant Produced	AYR	PICKERING
	Thickness (mm)	100 mm	100 mm
<b>SQFT PER</b>	Stone	0.43	0.43
	Layer	10.33	10.33
	Bundle	51.67	51.67
<b>PER BUNDLE</b>	Layers	5.00	5.00
<b>SOLDIER LNFT PER</b>	SqFt	0.76	0.76
	Layer	7.87	7.87
	Bundle	39.37	39.37
<b>SAILOR LNFT PER</b>	SqFt	3.05	3.05
	Layer	31.50	31.50
	Bundle	157.48	157.48
<b>UNITS PER</b>	SqFt	2.32	2.32
	Layer	24.00	24.00
	Bundle	120.00	120.00
<b>LBS PER</b>	Unit	20	20
	Layer	488	488
	Bundle	2,440	2,440

Colors	Reflectance	Stock	Stock
Opal Blend	SR .24 SRI 24	SO	-
Steel Gray Blend	SR n/a SRI n/a	SO	-
Dark Charcoal	SR n/a SRI n/a	-	SO
Granite Fusion	SR n/a SRI n/a	-	SO
Light Gray	SR n/a SRI n/a	-	SO

LAYING PATTERNS

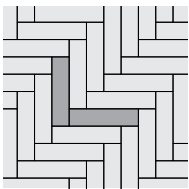

Promenade 4x16 HB

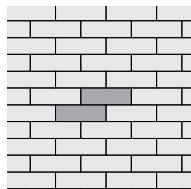

Promenade 4x16 RB

SINGLE UNIT



**4 x 16**  
 100 x 400 x 100mm  
 3 7/8 x 15 3/4 x 3 7/8"  
 120 Units/Bundle  
 .43 Sq.Ft./Stone



OPAL BLEND



STEEL GREY BLEND

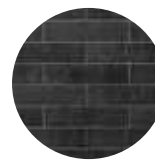

DARK CHARCOAL



GRANITE FUSION



LIGHT GREY

**Notes: Special Order (SO).** Minimum quantities apply. **Lead time required.** **SOLD IN FULL BUNDLES ONLY** and is produced and sold on a required, refundable skid. **Important: A urethane rubber paver mat must be used to prevent scuffing when compacting.**  
 All measurements are nominal. Contact Unilock for more information. **SPECIAL ORDER PRODUCT - NON-STOCK**



## APPLICATIONS

Pedestrian, Light Vehicular

## APPEARANCE

Edge Detail - Rounded

Surface Texture - Smooth, Series™ Exposed

& Il Campo® Brushed

Joint Spacing - 4 mm

## TECHNICAL INFORMATION

Conforms to ASTM C 936

Eligible for LEED v4.1 credits

		SMOOTH	IL CAMPO	SERIES
	Bundle Type	SINGLE	SINGLE	SINGLE
	Plant Produced	AYR	PICKERING	PICKERING
	Thickness (mm)	100 mm	100 mm	100 mm
SQFT PER	Stone	1.29	1.29	1.29
	Layer	10.33	10.33	10.33
	Bundle	51.67	51.67	51.67
PER BUNDLE	Layers	5.00	5.00	5.00
SOLDIER LNFT PER	SqFt	0.51	0.51	0.51
	Layer	5.25	5.25	5.25
	Bundle	26.25	26.25	26.25
SAILOR LNFT PER	SqFt	1.52	1.52	1.52
	Layer	15.75	15.75	15.75
	Bundle	78.74	78.74	78.74
UNITS PER	SqFt	0.77	0.77	0.77
	Layer	8.00	8.00	8.00
	Bundle	40.00	40.00	40.00
LBS PER	Unit	60	60	60
	Layer	478	478	478
	Bundle	2,391	2,391	2,391

Colors	Reflectance	Stock	Stock	Stock
Black Granite	SR n/a SRI n/a	-	-	SO
Dark Charcoal	SR n/a SRI n/a	-	SO	-
Granite Blend	SR n/a SRI n/a	-	SO	-
Light Gray	SR n/a SRI n/a	-	SO	-
Opal Blend	SR .24 SRI 24	SO	-	-
Steel Gray Blend	SR n/a SRI n/a	SO	-	-

LAYING PATTERNS

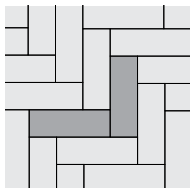

Promenade 8x24 HB

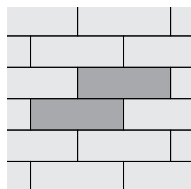

Promenade 8x24 RB

SINGLE UNITS



**8 x 24**  
**SMOOTH**  
200 x 600 x 100mm  
7 7/8 x 23 5/8 x 3 7/8"  
40 Units/Bundle  
1.29 Sq.Ft./Stone

**8 x 24**  
**SERIES EXPOSED**  
200 x 600 x 100mm  
7 7/8 x 23 5/8 x 3 7/8"  
40 Units/Bundle  
1.29 Sq.Ft./Stone

**8 x 24**  
**IL CAMPO BRUSHED**  
200 x 600 x 100mm  
7 7/8 x 23 5/8 x 3 7/8"  
40 Units/Bundle  
1.29 Sq.Ft./Stone

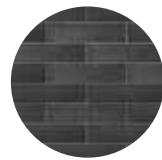

BLACK GRANITE

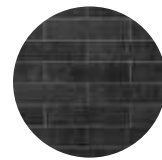

DARK CHARCOAL



GRANITE FUSION



LIGHT GREY



OPAL BLEND



STEEL GREY BLEND

**Notes: Special Order (SO).** Minimum quantities apply. **Lead time required.** **SOLD IN FULL BUNDLES ONLY** and is produced and sold on a required, refundable skid. **Important: A urethane rubber paver mat must be used to prevent scuffing when compacting.**  
All measurements are nominal. Contact Unilock for more information. **SPECIAL ORDER PRODUCT - NON-STOCK**



**APPLICATIONS**

Pedestrian, Light Vehicular

**APPEARANCE**

Edge Detail - n/a

Surface Texture - Textured

Joint Spacing - 10 mm

**TECHNICAL INFORMATION**

Conforms to ASTM C 936

Eligible for LEED v4.1 credits

		LARGE RECTANGLE
Bundle Type	RANDOM	SINGLE
Plant Produced	AYR	AYR
Thickness (mm)	60 mm	60 mm

SQFT PER	Stone	-	1.72
	Layer	11.29	10.30
	Bundle	90.30	82.39

PER BUNDLE	Layers	8.00	8.00
------------	--------	------	------

SOLDIER LNFT PER	SqFt	-	0.58
	Layer	-	5.94
	Bundle	-	47.56

SAILOR LNFT PER	SqFt	1.31	1.01
	Layer	14.78	10.39
	Bundle	118.22	83.15

UNITS PER	SqFt	-	0.58
	Layer	20.00	6.00
	Bundle	160.00	48.00

LBS PER	Unit	-	50
	Layer	309	301
	Bundle	2,472	2,411

Colors	Reflectance	Stock	Stock
Dawn Mist	SR .37 SRI 41	✓	SO
Pebble Taupe	SR .38 SRI 42	✓	SO
Smoke Shale	SR n/a SRI n/a	✓	SO

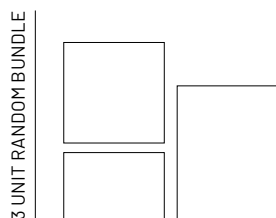
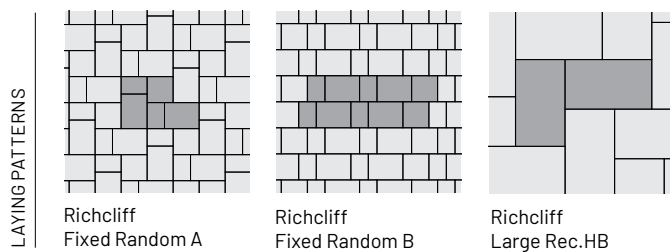
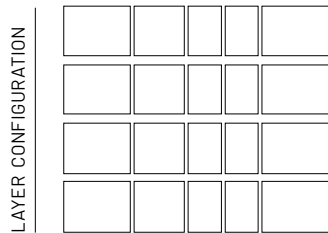

**RECTANGLE**  
226 x 300 x 60mm  
8 7/8 x 11 7/8 x 2 3/8"  
64 Units/Bundle  
.75 SqFt./Stone

**SQUARE**  
226 x 226 x 60mm  
8 7/8 x 8 7/8 x 2 3/8"  
32 Units/Bundle  
.58 Sq.Ft./Stone

**SMALL RECTANGLE**  
150 x 226 x 60mm  
5 7/8 x 8 7/8 x 2 3/8"  
64 Units/Bundle  
.38 Sq.Ft./Stone

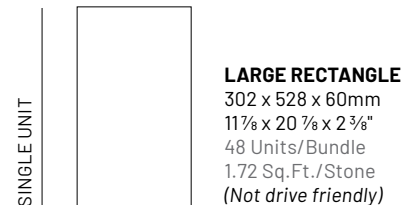

DAWN MIST      PEBBLE TAUPE      PEBBLE TAUPE DAWN MIST Blended on Site      SMOKE SHALE

Notes: Large Rectangles are special Order (SO). Minimum quantities apply. Lead time required. SOLD IN FULL BUNDLES ONLY and is produced and sold on a required, refundable skid. The Large Rectangle unit is not intended for vehicular applications. Important: A urethane rubber paver mat must be used to prevent scuffing when compacting. All measurements are nominal. Contact Unilock for more information.



## APPLICATIONS

Pedestrian, Light Vehicular, Border/Accents

## APPEARANCE

Edge Detail - Chamfer

Surface Texture - Series Exposed

Joint Spacing - 3mm

## TECHNICAL INFORMATION

Conforms to ASTM C 936

Eligible for LEED v4.1 credits

	4 x 8
Bundle Type	SINGLE
Plant Produced	CHICAGO
Thickness (mm)	60 mm

SQFT PER	Stone	0.22
	Layer	11.79
	Bundle	117.90

PER BUNDLE	Layers	10.00
------------	--------	-------

SOLDIER LNFT PER	SqFt	1.50
	Layer	17.72
	Bundle	177.17

SAILOR LNFT PER	SqFt	3.01
	Layer	35.43
	Bundle	354.33

UNITS PER	SqFt	4.58
	Layer	54.00
	Bundle	540.00

LBS PER	Unit	6
	Layer	306
	Bundle	3,065

Colors	Reflectance	Stock
Onyx Black	SR n/a SRI n/a	✓



ONYX BLACK

LAYING PATTERNS

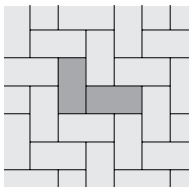

Series 4x8 HB

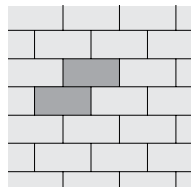

Series 4x8 RB

SINGLE UNITS



**4 x 8**  
 100 x 200 x 60mm  
 3 7/8 x 7 7/8 x 2 3/8"  
 540 Units/Bundle  
 .22 Sq.Ft./Stone

**Notes: SOLD IN FULL BUNDLES ONLY** and is produced and sold on a required, refundable skid. **Important: A urethane rubber paver mat must be used to prevent scuffing when compacting on textured surfaces.** All measurements are nominal. Contact Unilock for more information.



**APPLICATIONS**

Pedestrian, Roof Deck

**APPEARANCE**

Edge Detail - Micro  
 Surface Texture - Thermal/Flamed and Shot Blast  
 Joint Spacing - 0 mm

**TECHNICAL INFORMATION**

Conforms to ASTM C1782  
 Eligible for LEED v4.1 credits

**// Perfect for roof decks and other raised floor applications.**

Ask us about our Skyview™ pedestal system.  
 See page 89 for more information.

	16 x 32	SHOT BLAST
Bundle Type	SINGLE	SINGLE
Plant Produced	CHICAGO	CHICAGO
Thickness (mm)	50 mm	50 mm

<b>SQFT PER</b>	Stone	3.57	3.57
	Layer	-	-
	Bundle	64.27	64.27

<b>SOLDIER LNFT PER</b>	SqFt	0.37	0.38
	Layer	-	-
	Bundle	24.04	24.12

<b>SAILOR LNFT PER</b>	SqFt	0.75	0.75
	Layer	-	-
	Bundle	48.13	48.06

<b>UNITS PER</b>	SqFt	0.28	0.28
	Layer	-	-
	Bundle	18.00	18.00

<b>LBS PER</b>	Unit	86	86
	Layer	-	-
	Bundle	1,549	1,549

Colors	Reflectance	Stock	Stock
Dark Charcoal	SR n/a SRI n/a	-	<b>SO</b>
Light Granite	SR n/a SRI 50	<b>SO</b>	-
Toscana Beige	SR n/a SRI 77	<b>SO</b>	-

SLAB SPACERS



X & T Slab Spacers  
 Bagged Separately

LAYING PATTERNS

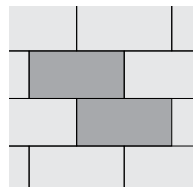

Soreno 16x32 RB

SINGLE UNITS



**16 x 32**  
 407 x 815 x 50mm  
 16 x 32 x 2"  
 18 Units/Bundle  
 3.57 Sq.Ft./Stone



DARK CHARCOAL

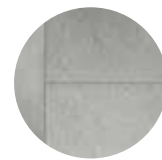

LIGHT GRANITE



TOSCANA BEIGE

**Notes: Special Order (SO).** Minimum quantities apply. **Lead time required. SOLD IN FULL BUNDLES ONLY** and is produced and sold on a required, refundable skid. **This product is not intended for vehicular applications. Important: A urethane rubber paver mat must be used to prevent scuffing when compacting.** All measurements are nominal. Contact Unilock for more information.



### APPLICATIONS

Pedestrian, Light Vehicular, Permeable

### APPEARANCE

Edge Detail - Zero

Surface Texture - Textured

Joint Spacing - 11-18 mm

Void - 4.4%

### TECHNICAL INFORMATION

Conforms to ASTM C 936

Eligible for LEED v4.1 credits

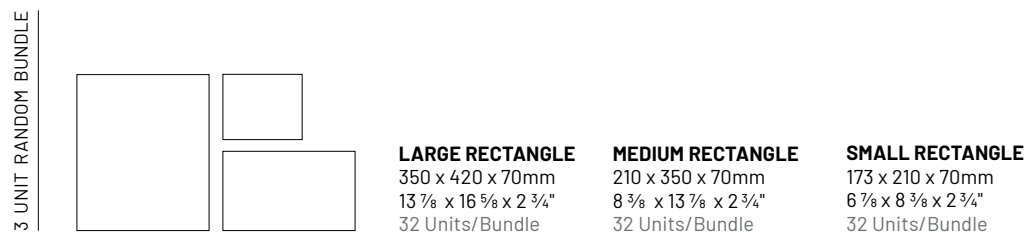
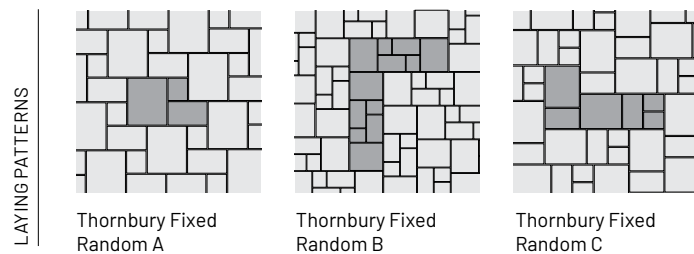
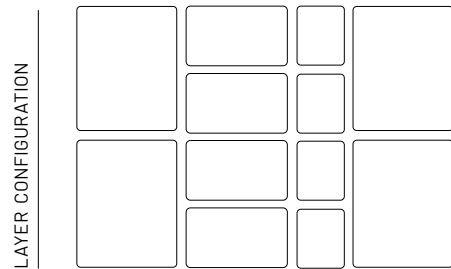

Bundle Type	RANDOM
Plant Produced	MICHIGAN
Thickness (mm)	70 mm

<b>SQFT PER</b>	Stone	-
	Layer	11.08
	Bundle	88.61

<b>PER BUNDLE</b>	Layers	8.00
-------------------	--------	------

<b>SOLDIER LNFT PER</b>	SqFt	-
	Layer	-
	Bundle	-

<b>SAILOR LNFT PER</b>	SqFt	-
	Layer	-
	Bundle	-

<b>UNITS PER</b>	SqFt	-
	Layer	12.00
	Bundle	96.00

<b>LBS PER</b>	Unit	-
	Layer	355
	Bundle	2,837

Colors	Reflectance	Stock
Birch	SR n/a SRI n/a	✓
Sierra	SR n/a SRI n/a	✓

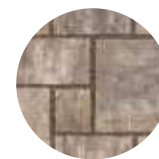

BIRCH



SIERRA

Notes: SOLD IN FULL BUNDLES ONLY. Important: A urethane rubber paver mat must be used to prevent scuffing when compacting. All measurements are nominal. Contact Unilock for more information.



## APPLICATIONS

Pedestrian, Light Vehicular, Roadway Street,  
Border/Accents, Permeable

## APPEARANCE

Edge Detail - n/a  
Surface Texture - Textured  
Joint Spacing - 10 mm  
Void - 6.50%

## TECHNICAL INFORMATION

Conforms to ASTM C 936  
Eligible for LEED v4.1 credits

	STANDARD
Bundle Type	SINGLE
Plant Produced	AYR
Thickness (mm)	70 mm

SQFT PER	Stone	0.28
	Layer	11.05
	Bundle	88.41

PER BUNDLE	Layers	8.00
------------	--------	------

SOLDIER LNFT PER	SqFt	1.19
	Layer	13.12
	Bundle	104.99

SAILOR LNFT PER	SqFt	2.97
	Layer	32.81
	Bundle	262.47

UNITS PER	SqFt	3.62
	Layer	40.00
	Bundle	320.00

LBS PER	Unit	9
	Layer	361
	Bundle	2,888

Colors	Reflectance	Stock
Basalt	SR n/a SRI n/a	✓
Burgundy Red	SR n/a SRI n/a	✓
Burnt Clay	SR n/a SRI n/a	✓
Old Oak	SR n/a SRI n/a	✓

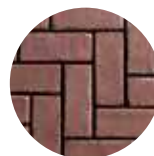

BURGUNDY RED



OLD OAK



BURNT CLAY



3 COLOR BLEND  
Blended on Site



BASALT

LAYING PATTERNS

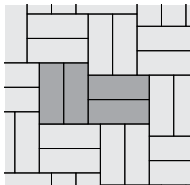

TownHall 4x10 DHB

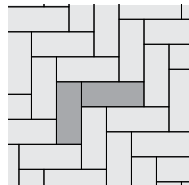

TownHall 4x10 HB

SINGLE UNIT



**STANDARD**  
100 x 250 x 70mm  
3 7/8 x 9 7/8 x 2 3/4"  
320 Units/Bundle  
.28 Sq.Ft./Stone

Notes: SOLD IN FULL BUNDLES ONLY and is produced and sold on a required, refundable skid. Important: A urethane rubber paver mat must be used to prevent scuffing when compacting. All measurements are nominal. Contact Unilock for more information.



### APPLICATIONS

Pedestrian, Light Vehicular, Permeable

### APPEARANCE

Edge Detail - Rounded

Surface Texture - Smooth

Joint Spacing - 7 mm

Void - 5.5%

### TECHNICAL INFORMATION

Conforms to ASTM C 936

Eligible for LEED v4.1 credits

	SMOOTH
Bundle Type	RANDOM
Plant Produced	MICHIGAN
Thickness (mm)	60 mm

SQFT PER	Stone	-
	Layer	11.69
	Bundle	105.18

PER BUNDLE	Layers	9.00
------------	--------	------

SOLDIER LNFT PER	SqFt	-
	Layer	-
	Bundle	-

SAILOR LNFT PER	SqFt	1.57
	Layer	18.35
	Bundle	165.11

UNITS PER	SqFt	-
	Layer	21.00
	Bundle	189.00

LBS PER	Unit	-
	Layer	321
	Bundle	2,886

Colors	Reflectance	Stock
Fossil	SR n/a SRI n/a	✓
Granite	SR n/a SRI n/a	✓
Limestone	SR n/a SRI n/a	✓
Grindstone	SR n/a SRI n/a	✓

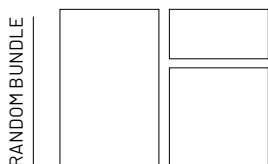
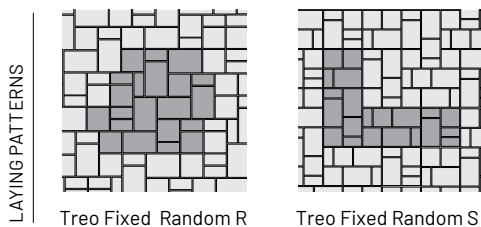
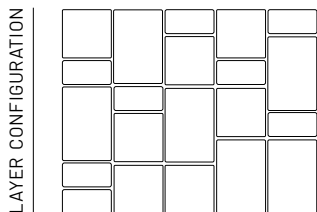

**LARGE RECTANGLE**  
 225 x 337.5 x 60mm  
 8 7/8 x 13 3/8 x 2 3/8"  
 54 Units/Bundle  
 .82 Sq.Ft./Stone

**SQUARE**  
 225 x 225 x 60mm  
 8 7/8 x 8 7/8 x 2 3/8"  
 63 Units/Bundle  
 .55 Sq.Ft./Stone

**SMALL RECTANGLE**  
 112.5 x 225 x 60mm  
 4 1/2 x 8 7/8 x 2 3/8"  
 72 Units/Bundle  
 .27 Sq.Ft./Stone

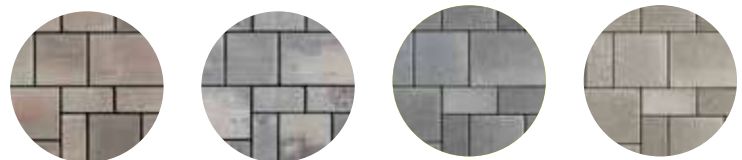

FOSSIL

GRANITE

LIMESTONE

GRINDSTONE

**Notes: SOLD IN FULL BUNDLES ONLY** and is produced and sold on a required, refundable skid. **Important: A urethane rubber paver mat must be used to prevent scuffing when compacting on textured surfaces.** All measurements are nominal. Contact Unilock for more information.



## APPLICATIONS

Pedestrian, Light Vehicular, Permeable

## APPEARANCE

Edge Detail - Micro

Surface Texture - Series Exposed Textured

Joint Spacing - 10mm

Void - 5.6%

## TECHNICAL INFORMATION

Conforms to ASTM C 936

Eligible for LEED v4.1 credits

Bundle Type	RANDOM
Plant Produced	CHICAGO
Thickness (mm)	70 mm

SQFT PER	Stone	-
	Layer	12.19
	Bundle	97.53

PER BUNDLE	Layers	8.00
------------	--------	------

SOLDIER LNFT PER	SqFt	-
	Layer	-
	Bundle	-

SAILOR LNFT PER	SqFt	2.34
	Layer	28.49
	Bundle	227.95

UNITS PER	SqFt	-
	Layer	38.00
	Bundle	304.00

LBS PER	Unit	-
	Layer	378
	Bundle	3,022

Colors	Reflectance	Stock
Cobalt Grey	SR n/a SRI n/a	✓
Peppered Granite	SR .38 SRI 42	✓

LAYER CONFIGURATION

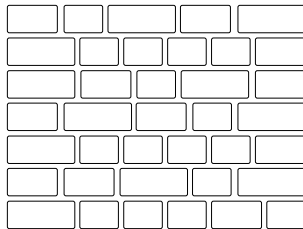

LAYING PATTERNS

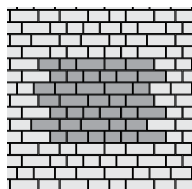

TribecaCobble Fixed Random

RANDOM BUNDLE

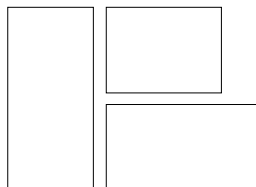

### LARGE RECTANGLE

130 x 305 x 70mm  
5 x 12 x 2 3/4"  
88 Units/Bundle  
.43 Sq.Ft./Stone

### RECTANGLE

130 x 230 x 70mm  
5 x 9 x 2 3/4"  
88 Units/Bundle  
.32 Sq.Ft./Stone

### SMALL RECTANGLE

130 x 175 x 70mm  
5 x 6 7/8 x 2 3/4"  
128 Units/Bundle  
.25 Sq.Ft./Stone



COBALT GREY



PEPPERED GRANITE

**Important:** A urethane rubber paver mat must be used to prevent scuffing when compacting on textured surfaces. For permeable installations, Unilock recommends using granite chips for joint filler. For traditional applications, please refer to the Polymeric Sand Best Practices on page 98. All measurements are nominal. Contact Unilock for more information.



## APPLICATIONS

Pedestrian, Light Vehicular, Permeable,  
Roadway Street

## APPEARANCE

Edge Detail - Zero  
Surface Texture - Standard  
Joint Spacing - 2 mm  
Void - 40%

## TECHNICAL INFORMATION

Conforms to ASTM C1319  
Eligible for LEED v4.1 credits

		SMOOTH
	Bundle Type	SINGLE
	Plant Produced	MICHIGAN
	Thickness (mm)	80 mm

<b>SQFT PER</b>	Stone	2.50
	Layer	10.00
	Bundle	80.00

<b>PER BUNDLE</b>	Layers	8.00
-------------------	--------	------

<b>SOLDIER LNFT PER</b>	SqFt	-
	Layer	-
	Bundle	-

<b>SAILOR LNFT PER</b>	SqFt	-
	Layer	-
	Bundle	-

<b>UNITS PER</b>	SqFt	0.40
	Layer	4.00
	Bundle	32.00

<b>LBS PER</b>	Unit	62
	Layer	247
	Bundle	1,975

Colors	Reflectance	Stock
Natural	SR .30 SRI 32	✓

LAYER CONFIGURATION

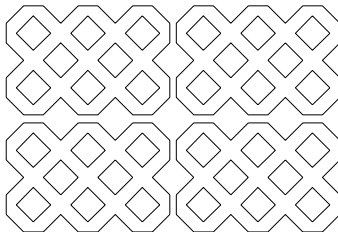

LAYING PATTERNS

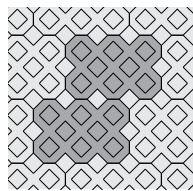

Turfstone A

SINGLE UNIT

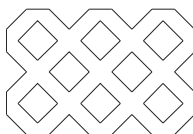

**STANDARD**  
400 x 600 x 80mm  
15 3/4 x 23 5/8 x 3 1/8"  
32 Units/Bundle  
2.50 Sq.Ft./Stone



NATURAL

Notes: **SOLD IN FULL BUNDLES ONLY.** All measurements are nominal. Contact Unilock for more information.



## APPLICATIONS

Pedestrian

## APPEARANCE

Edge Detail - Rounded

Surface Texture - Umbriano Mottled

Joint Spacing - 4 mm

## TECHNICAL INFORMATION

Conforms to ASTM C 936

Eligible for LEED v4.1 credits

	12 x 24	24 x 24
Bundle Type	SINGLE	RANDOM
Plant Produced	ONTARIO	ONTARIO
Thickness (mm)	50 mm	50 mm

SQFT PER	Stone	1.94	3.88
	Layer	11.63	7.75
	Bundle	58.13	38.75

PER BUNDLE	Layers	5.00	5.00
------------	--------	------	------

SOLDIER LNFT PER	SqFt	-	0.52
	Layer	-	4.00
	Bundle	-	20.00

SAILOR LNFT PER	SqFt	-	0.52
	Layer	-	4.00
	Bundle	-	20.00

UNITS PER	SqFt	0.52	-
	Layer	6	2
	Bundle	30	10

LBS PER	Unit	43	-
	Layer	261	175
	Bundle	1,303	874

Colors	Reflectance	Stock	Stock
French Grey	SR .18 SRI 17	SO	SO
Grenada White	SR .45 SRI 52	SO	SO

LAYER CONFIGURATION

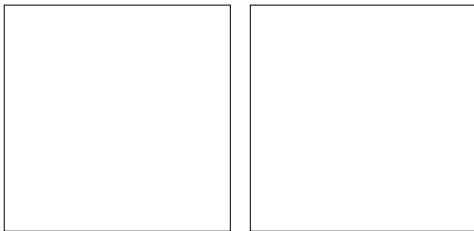

LAYING PATTERNS

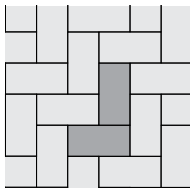

Umbriano 12x24 HB

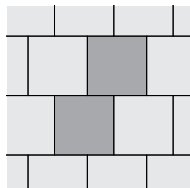

Umbriano 24x24 RB

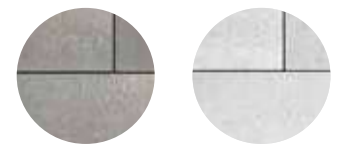

FRENCH GREY

GRENADA WHITE

SINGLE UNITS



**12 x 24**  
300 x 600 x 50mm  
11 7/8 x 23 5/8 x 2"  
30 Units/Bundle  
1.94 Sq.Ft./Stone

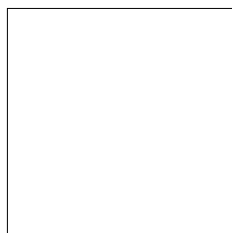

**24 x 24**  
600 x 600 x 50mm  
23 5/8 x 23 5/8 x 2"  
10 Units/Bundle  
3.88 Sq.Ft./Stone

**Notes: Special Order (SO).** Minimum quantities apply. **Lead time required.** **SOLD IN FULL BUNDLES ONLY** and is produced and sold on a required, refundable skid. **Important: A urethane rubber paver mat must be used to prevent scuffing when compacting on textured surfaces. This product is not intended for vehicular use.** All measurements are nominal. Contact Unilock for more information.



## APPLICATIONS

Pedestrian

## APPEARANCE

Edge Detail - Zero

Surface Texture - Umbriano Mottled

Joint Spacing - 3 mm

## TECHNICAL INFORMATION

Conforms to ASTM C 936

Eligible for LEED v4.1 credits

		SMALL RECTANGLE
Bundle Type	RANDOM	SINGLE
Plant Produced	GEORGETOWN	GEORGETOWN
Thickness (mm)	60 mm	60 mm

SQFT PER	Stone	-	0.70
	Layer	10.46	10.46
	Bundle	94.14	94.16

PER BUNDLE	Layers	9.00	9.00
------------	--------	------	------

SOLDIER LNFT PER	SqFt	-	0.85
	Layer	-	8.86
	Bundle	-	79.72

SAILOR LNFT PER	SqFt	0.85	1.69
	Layer	8.86	17.72
	Bundle	79.72	159.45

UNITS PER	SqFt	-	1.43
	Layer	8.00	15.00
	Bundle	72.00	135.00

LBS PER	Unit	-	19
	Layer	287.14	285.94
	Bundle	2,584	2,573

Colors	Reflectance	Stock	Stock
French Grey	SR .18 SRI 17	✓	-
Grenada White	SR .45 SRI 52	✓	-
Summer Wheat	SR .42 SRI 48	✓	-
Winter Marvel	SR .35 SRI 38	✓	-
Midnight Sky	SR .17 SRI 15	-	✓

LAYER CONFIGURATION

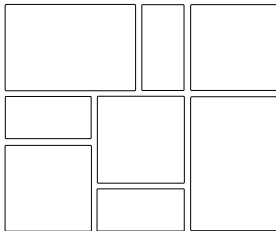

LAYING PATTERNS

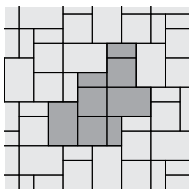

Umbriano Fixed Random A

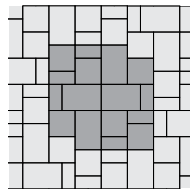

Umbriano Fixed Random B

RANDOM BUNDLE

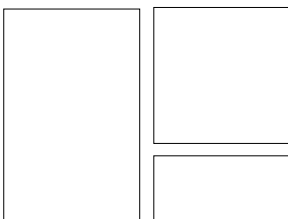

**LARGE RECTANGLE**  
360 x 540 x 60mm  
14 x 21 x 2 3/8"  
18 Units/Bundle

**SQUARE**  
360 x 360 x 60mm  
14 1/4 x 14 1/4 x 2 3/8"  
27 Units/Bundle

**SMALL RECTANGLE**  
180 x 360 x 60mm  
7 x 14 1/4 x 2 3/8"  
27 Units/Bundle

SINGLE UNIT



**SMALL RECTANGLE**  
180 x 360 x 60mm  
7 x 14 x 2 3/8"  
135 Units/Bundle  
.70 Sq.Ft./Stone

Notes: Special Order (SO). Minimum quantities apply. Lead time required. SOLD IN FULL BUNDLES ONLY and is produced and sold on a required, refundable skid. Important: A urethane rubber paver mat must be used to prevent scuffing when compacting on textured surfaces. All measurements are nominal. Contact Unilock for more information.

# Umbriano® 60mm Slabs



## APPLICATIONS

Pedestrian

## APPEARANCE

Edge Detail - Zero

Surface Texture - Umbriano Mottled

Joint Spacing - 4 mm

## TECHNICAL INFORMATION

Conforms to ASTM C 936

Eligible for LEED v4.1 credits

	18 x 36
Bundle Type	SINGLE
Plant Produced	ONTARIO
Thickness (mm)	60 mm

SQFT PER	Stone	4.36
	Layer	8.72
	Bundle	52.31

PER BUNDLE	Layers	6.00
------------	--------	------

SOLDIER LNFT PER	SqFt	0.68
	Layer	5.91
	Bundle	35.44

SAILOR LNFT PER	SqFt	1.35
	Layer	11.81
	Bundle	70.87

UNITS PER	SqFt	0.23
	Layer	2.00
	Bundle	12.00

LBS PER	Unit	120
	Layer	239
	Bundle	1,436

Colors	Reflectance	Stock
French Grey	SR .18 SRI 17	SO
Grenada White	SR .45 SRI 52	SO
Summer Wheat	SR .42 SRI 48	SO
Winter Marvel	SR .35 SRI 38	SO

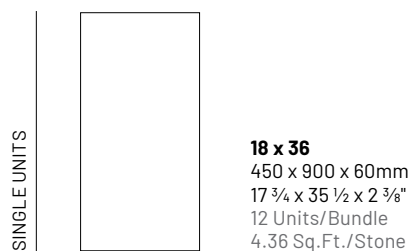
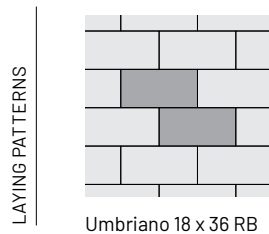

Notes: Special Order (SO). Minimum quantities apply. Lead time required. SOLD IN FULL BUNDLES ONLY and is produced and sold on a required, refundable skid. Important: A urethane rubber paver mat must be used to prevent scuffing when compacting on textured surfaces. This product is not intended for vehicular use. All measurements are nominal. Contact Unilock for more information.



## APPLICATIONS

Pedestrian

## APPEARANCE

Edge Detail - Zero

Surface Texture - Umbriano Mottled

Joint Spacing - 7 mm

## TECHNICAL INFORMATION

Conforms to ASTM C 936

Eligible for LEED v4.1 credits

	8 x 16	8 x 24	12 x 24	24 x 24
Bundle Type	SINGLE	SINGLE	SINGLE	SINGLE
Plant Produced	ONTARIO	ONTARIO	ONTARIO	ONTARIO
Thickness (mm)	70 mm	70 mm	70 mm	70 mm

SQFT PER	Stone	0.86	1.29	1.94	3.88
	Layer	10.33	10.33	11.63	7.75
	Bundle	82.67	82.67	93.00	62.00

PER BUNDLE	Layers	8.00	8.00	8.00	8.00
------------	--------	------	------	------	------

SOLDIER LNFT PER	SqFt	0.76	0.51	0.51	0.51
	Layer	7.87	5.25	5.91	3.94
	Bundle	62.99	41.99	47.24	31.50

SAILOR LNFT PER	SqFt	1.52	1.02	1.02	0.51
	Layer	15.75	10.50	11.81	3.94
	Bundle	125.98	83.99	94.49	31.50

UNITS PER	SqFt	1.16	0.77	0.52	0.26
	Layer	12.00	8.00	6.00	2.00
	Bundle	96.00	64.00	48.00	16.00

LBS PER	Unit	29	41	65	129
	Layer	343	331	393	258
	Bundle	2,746	2,647	3,142	2,062

Colors	Reflectance	Stock	Stock	Stock	Stock
French Grey	SR .18 SRI 17	SO	SO	SO	SO
Grenada White	SR .45 SRI 52	SO	SO	SO	SO
Midnight Sky	SR .17 SRI 15	SO	SO	SO	SO
Summer Wheat	SR .42 SRI 48	SO	SO	SO	SO
Winter Marvel	SR .35 SRI 38	SO	SO	SO	SO



FRENCH GREY

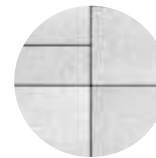

GRENADA WHITE

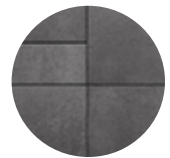

MIDNIGHT SKY



SUMMER WHEAT

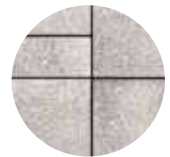

WINTER MARVEL

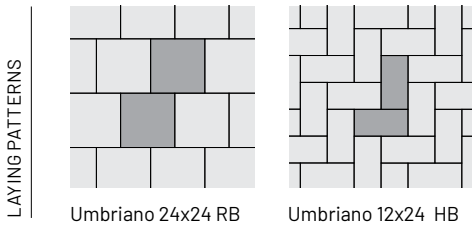

LAYING PATTERNS

Umbriano 24x24 RB

Umbriano 12x24 HB

SINGLE UNITS	8 x 16	8 x 24	12 x 24	24 x 24
	200 x 400 x 70mm 7 7/8 x 15 3/4 x 2 3/4" 96 Units/Bundle .86 Sq.Ft./Stone			
		200 x 600 x 70mm 7 7/8 x 23 5/8 x 2 3/4" 64 Units/Bundle 1.29 Sq.Ft./Stone	300 x 600 x 70mm 11 7/8 x 23 5/8 x 2 3/4" 48 Units/Bundle 1.94 Sq.Ft./Stone	600 x 600 x 70mm 2 3/8 x 23 5/8 x 2 3/4" 16 Units/Bundle 3.88 Sq.Ft./Stone

Notes: Special Order (SO). Minimum quantities apply. Lead time required. SOLD IN FULL BUNDLES ONLY and is produced and sold on a required, refundable skid. Important: A urethane rubber paver mat must be used to prevent scuffing when compacting on textured surfaces. All measurements are nominal. Contact Unilock for more information.



## APPLICATIONS

Pedestrian, Light Vehicular,

## APPEARANCE

Edge Detail - Zero

Surface Texture - Umbriano Mottled

Joint Spacing - 7 mm

## TECHNICAL INFORMATION

Conforms to ASTM C 936

Eligible for LEED v4.1 credits

		4 x 12 PERMEABLE	7 x 14
Bundle Type	RANDOM	SINGLE	SINGLE
Plant Produced	GEORGETOWN	MARENGO	GEORGETOWN
Thickness (mm)	80 mm	80 mm	80 mm

SQFT PER	Stone	-	0.32	0.70
	Layer	10.46	11.63	10.46
	Bundle	73.22	93.04	73.24

PER BUNDLE	Layers	7.00	8.00	7.00
------------	--------	------	------	------

SOLDIER LNFT PER	SqFt	-	1.02	0.85
	Layer	-	-	8.86
	Bundle	-	94.49	62.01

SAILOR LNFT PER	SqFt	0.85	3.05	1.69
	Layer	8.86	35.43	17.72
	Bundle	62.01	283.46	124.02

UNITS PER	SqFt	-	3.10	1.43
	Layer	8.00	36.00	15.00
	Bundle	56.00	288.00	105.00

LBS PER	Unit	-	12	19
	Layer	383	426	287
	Bundle	2,679	3,404	2,009

Colors	Reflectance	Stock	Stock	Stock
Grenada White	SR .45 SRI 52	SO	-	-
Summer Wheat	SR .42 SRI 48	SO	-	-
French Grey	SR .18 SRI 17	SO	SO	-
Winter Marvel	SR .35 SRI 38	SO	SO	-
Midnight Sky	SR .17 SRI 15	SO	SO	SO

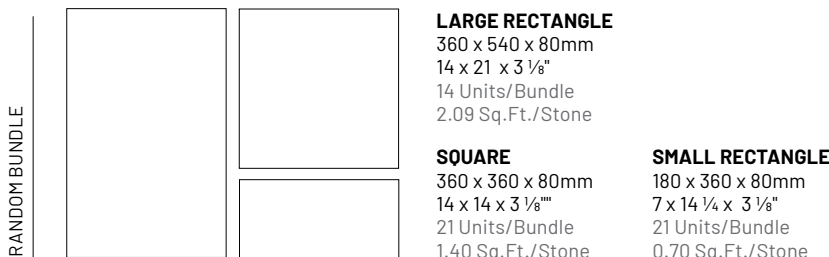
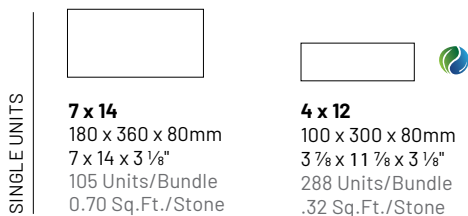
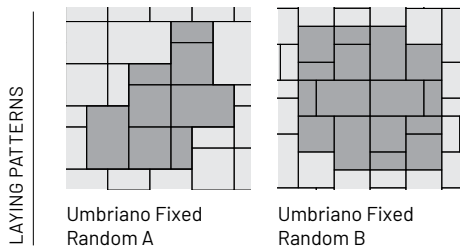

Notes: Special Order (SO). Minimum quantities apply. Lead time required. SOLD IN FULL BUNDLES ONLY and is produced and sold on a required, refundable skid. Important: A urethane rubber paver mat must be used to prevent scuffing when compacting on textured surfaces. All measurements are nominal. Contact Unilock for more information.



## APPLICATIONS

Pedestrian, Light Vehicular

## APPEARANCE

Edge Detail - Rounded

Surface Texture - Umbriano Mottled

Joint Spacing - 7 mm

## TECHNICAL INFORMATION

Conforms to ASTM C 936

Eligible for LEED v4.1 credits

	18 x 36	36 x 36
Bundle Type	SINGLE	SINGLE
Plant Produced	ONTARIO	ONTARIO
Thickness (mm)	100 mm	100 mm

SQFT PER	Stone	4.36	8.72
	Layer	8.72	8.72
	Bundle	43.59	43.59

PER BUNDLE	Layers	5.00	5.00
------------	--------	------	------

SOLDIER LNFT PER	SqFt	0.34	0.34
	Layer	2.95	2.95
	Bundle	14.75	14.75

SAILOR LNFT PER	SqFt	0.68	0.34
	Layer	5.90	2.95
	Bundle	29.50	14.75

UNITS PER	SqFt	0.23	0.11
	Layer	2.00	1.00
	Bundle	10.00	5.00

LBS PER	Unit	199	399
	Layer	399	399
	Bundle	1,994	1,994

Colors	Reflectance	Stock	Stock
French Grey	SR .18 SRI 17	SO	SO
Grenada White	SR .45 SRI 52	SO	SO
Summer Wheat	SR .42 SRI 48	SO	SO
Winter Marvel	SR .35 SRI 38	SO	SO

LAYING PATTERNS

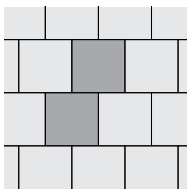

Umbriano 36 x 36 RB

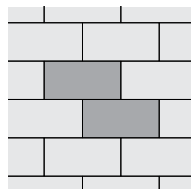

Umbriano 18 x 36 RB



FRENCH GREY

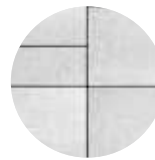

GRENADA WHITE



SUMMER WHEAT

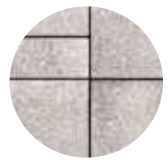

WINTER MARVEL

SINGLE UNITS

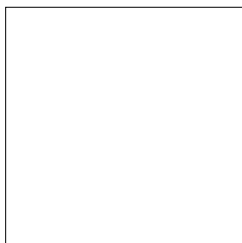

**36 x 36**  
900 x 900 x 100mm  
35 1/2 x 35 1/2 x 3 7/8"  
5 Units/Bundle  
8.72 Sq.Ft./Stone



**18 x 36**  
450 x 900 x 100mm  
17 3/4 x 35 1/2 x 3 7/8"  
10 Units/Bundle  
4.36 Sq.Ft./Stone

**Notes: Special Order (SO).** Minimum quantities apply. **Lead time required. SOLD IN FULL BUNDLES ONLY** and is produced and sold on a required, refundable skid. **Important: A urethane rubber paver mat must be used to prevent scuffing when compacting on textured surfaces.** All measurements are nominal. Contact Unilock for more information.



**APPLICATIONS**

Pedestrian, Roof Deck

**APPEARANCE**

Edge Detail - Rounded

Surface Texture - Smooth

Joint Spacing - 4 mm

**TECHNICAL INFORMATION**

Conforms to ASTM C 936

Eligible for LEED v4.1 credits

		8 x 15	9 x 9
	Bundle Type	SINGLE	SINGLE
	Plant Produced	ONTARIO	ONTARIO
	Thickness (mm)	60 mm	60 mm

SQFT PER	Stone	0.78	0.54
	Layer	11.66	10.90
	Bundle	104.91	98.08

PER BUNDLE	Layers	9.00	9.00
------------	--------	------	------

SOLDIER LNFT PER	SqFt	0.80	-
	Layer	9.35	-
	Bundle	84.15	-

SAILOR LNFT PER	SqFt	1.60	1.35
	Layer	18.70	14.74
	Bundle	168.31	132.63

UNITS PER	SqFt	1.29	1.84
	Layer	15.00	20.00
	Bundle	135.00	180.00

LBS PER	Unit	21	15
	Layer	320	299
	Bundle	2,878	2,692

Colors	Reflectance	Stock	Stock
Indiana Buff	SR .n/a SRI n/a	SO	-
Sterling	SR .n/a SRI n/a	SO	-
Dark Charcoal	SR .n/a SRI n/a	-	SO



INDIANA BUFF



STERLING



DARK CHARCOAL

SINGLE UNITS

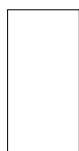

**8 x 15**  
190 x 380 x 60mm  
7 1/2 x 15 x 2 3/8"  
135 Units/Bundle  
0.78 Sq.Ft./Stone



**9 x 9**  
228 x 228 x 60mm  
9 x 9 x 2 3/8"  
180 Units/Bundle  
0.54 Sq.Ft./Stone

Notes: Special Order (SO). Minimum quantities apply. Lead time required. SOLD IN FULL BUNDLES ONLY and is produced and sold on a required, refundable skid. Important: A urethane rubber paver mat must be used to prevent scuffing when compacting on textured surfaces. All measurements are nominal. Contact Unilock for more information.



## APPLICATIONS

Pedestrian, Roof Deck, Light Vehicular

## APPEARANCE

Edge Detail - Rounded

Surface Texture - Smooth

Joint Spacing - 4 mm

## TECHNICAL INFORMATION

Conforms to ASTM C 936

Eligible for LEED v4.1 credits

LAYER CONFIGURATION

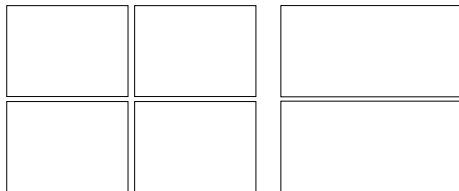

LAYING PATTERNS

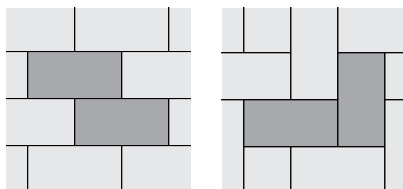

Urban 18x36 RB

Urban 18 x 36 HB

SINGLE UNITS  
SLABS



**18 x 36**  
450 x 900 x 60mm  
17 3/4 x 35 1/2 x 2 3/8"  
12 Units/Bundle  
4.36 Sq.Ft./Stone

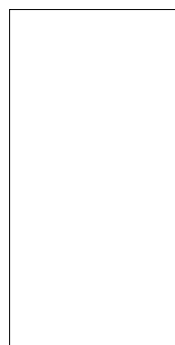

**18 x 36**  
450 x 900 x 100mm  
17 3/4 x 35 1/2 x 4"  
10 Units/Bundle  
4.36 Sq.Ft./Stone

		18 x 36	18 x 36
	Bundle Type	SINGLE	SINGLE
	Plant Produced	ONTARIO	ONTARIO
	Thickness (mm)	60 mm	100 mm

SQFT PER	Stone	4.36	4.36
	Layer	8.72	8.72
	Bundle	52.31	43.59

PER BUNDLE	Layers	6.00	5.00
------------	--------	------	------

SOLDIER LNFT PER	SqFt	0.68	0.68
	Layer	5.91	5.91
	Bundle	35.44	29.53

SAILOR LNFT PER	SqFt	1.35	1.35
	Layer	11.81	11.81
	Bundle	70.87	59.06

UNITS PER	SqFt	0.23	0.23
	Layer	2.00	2.00
	Bundle	12.00	10.00

LBS PER	Unit	145	199
	Layer	290	399
	Bundle	1,739	1,994

Colors	Reflectance	Stock	Stock
Indiana Buff	SR .52 SRI 61	✓	SO
Sterling	SR .41 SRI 46	✓	SO
Linen Buff	SR .n/a SRI n/a	SO	-
Linen Grey	SR .n/a SRI n/a	SO	-



INDIANA BUFF

STERLING

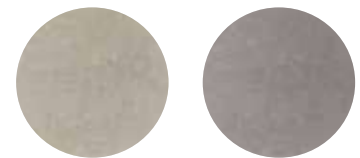

LINEN BUFF

LINEN GREY

Notes: Special Order (SO). Minimum quantities apply. Lead time required. SOLD IN FULL BUNDLES ONLY and is produced and sold on a required, refundable skid. Important: A urethane rubber paver mat must be used to prevent scuffing when compacting on textured surfaces. All measurements are nominal. Contact Unilock for more information.



## APPLICATIONS

Pedestrian, Light Vehicular, Border/Accents

## APPEARANCE

Edge Detail - Zero

Surface Texture - Textured

Joint Spacing - 3-7 mm

## TECHNICAL INFORMATION

Conforms to ASTM C 936

Eligible for LEED v4.1 credits

Bundle Type	RANDOM
Plant Produced	MICHIGAN
Thickness (mm)	70 mm

SQFT PER	Stone	-
	Layer	11.77
	Bundle	94.19

PER BUNDLE	Layers	8.00
------------	--------	------

SOLDIER LNFT PER	SqFt	-
	Layer	-
	Bundle	-

SAILOR LNFT PER	SqFt	1.24
	Layer	14.57
	Bundle	116.56

UNITS PER	SqFt	-
	Layer	20.00
	Bundle	160.00

LBS PER	Unit	-
	Layer	367
	Bundle	2,937

Colors	Reflectance	Stock
Beechwood	SR n/a SRI n/a	✓
Granite	SR n/a SRI n/a	✓

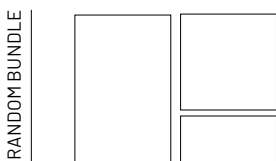
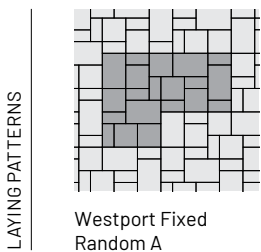
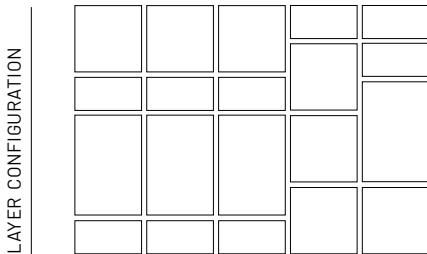

**LARGE RECTANGLE**  
254 x 380 x 70mm  
10 x 15 x 2 3/4"  
32 Units/Bundle

**SQUARE**  
254 x 254 x 70mm  
10 x 10 x 2 3/4"  
56 Units/Bundle

**SMALL RECTANGLE**  
127 x 254 x 70mm  
5 x 10 x 2 3/4"  
72 Units/Bundle



BEECHWOOD



GRANITE

**Notes: SOLD IN FULL BUNDLES ONLY. Important:** A urethane rubber paver mat must be used to prevent scuffing when compacting on textured surfaces. All measurements are nominal. Contact Unilock for more information.

# Brussels Dimensional Stone®



## APPLICATIONS

Garden Wall, Seat Wall, Outdoor Kitchen, Fire Feature, Water Feature

## APPEARANCE

Surface Texture - Tumbled

## CROSS SECTIONS

Cross Sections are available on Unilock's Contractor website under Products:

[contractor.unilock.com](http://contractor.unilock.com)

## TECHNICAL INFORMATION

Conforms to ASTM C 1372

Eligible for LEED v4.1 credits

	STANDARD
Bundle Type	SINGLE
Plant Produced	MICHIGAN
Thickness (mm)	100 mm

FCFT PER	Stone	0.33
	Layer	5.33
	Bundle	32.00

PER BUNDLE	Layers	6.00
	Sections	4.00

LNFT PER	Unit	1.00
	Bundle	96.00

UNITS PER	SqFt	3.00
	Section	24.00
	Layer	16
	Bundle	96.00

LBS PER	Units	31
	Section	755
	Layer	503
	Bundle	3,020

Colors	Reflectance	Stock
Coffee Creek	SR n/a SRI n/a	✓
Charcoal	SR n/a SRI n/a	✓
Limestone	SR n/a SRI n/a	✓
Sandstone	SR n/a SRI n/a	✓
Sierra	SR n/a SRI n/a	✓



COFFEE CREEK



CHARCOAL



LIMESTONE



SANDSTONE



SIERRA

SINGLE UNITS

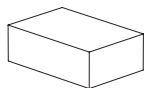

**STANDARD**  
300 x 200 x 100mm  
11<sup>1</sup>/<sub>8</sub> x 7<sup>7</sup>/<sub>8</sub> x 3<sup>3</sup>/<sub>8</sub>"  
96 Units/Bundle  
.33 Fc.Ft./Stone

SUNSET FIRE PIT KIT

Located on page 86



Round



Square

**Notes: SOLD IN FULL BUNDLES ONLY.** Maximum height is 24" (under optimum conditions). \*Based on 12" deep wall coverage = 21.4 sqft per bundle. Based on an 8" deep wall coverage = 32 sqft per bundle. LedgeStone, Brussels XL complement as a possible coping unit. All measurements are nominal. Contact Unilock for more information.

# DuraHold®



## APPLICATIONS

Structural Walls

## APPEARANCE

Surface Texture - Standard

## CROSS SECTIONS

Cross Sections are available on Unilock's

Contractor website under Products:

[contractor.unilock.com](http://contractor.unilock.com)

## TECHNICAL INFORMATION

Conforms to ASTM C 1372

Eligible for LEED v4.1 credits

	STANDARD HALF	STANDARD	CORNER 45°	CORNER 90°
Bundle Type	SINGLE	SINGLE	SINGLE	SINGLE
Plant Produced	GORMLEY	GORMLEY	GORMLEY	GORMLEY
Thickness (mm)	300 mm	300 mm	300 mm	300 mm

FCFT PER	Stone	3.00	6.02	7.04	7.04
	Layer	3.00	6.02	7.04	7.04
	Bundle	3.00	6.02	7.04	7.04

PER BUNDLE	Layers	1.00	1.00	1.00	1.00
------------	--------	------	------	------	------

LNFT PER	Unit	3.00	6.02	-	-
	Bundle	3.00	6.02	-	-

UNITS PER	SqFt	0.33	0.17	0.14	0.14
	Layer	1	1	1	1
	Bundle	1.00	1.00	1.00	1.00

LBS PER	Units	800	1,680	1,480	1,320
	Layer	800	1,680	1,480	1,320
	Bundle	800	1,680	1,480	1,320

Colors	Reflectance	Stock	Stock	Stock	Stock
Natural	SR n/a SRI n/a	SO	SO	SO	SO



NATURAL

SINGLE UNITS

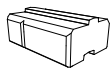

**STANDARD HALF**  
915 x 600 x 300mm  
36 x 23<sup>3</sup>/<sub>8</sub> x 11<sup>1</sup>/<sub>8</sub>"  
1 Unitss/Bundle  
3.00 Fc.Ft./Stone

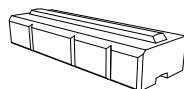

**STANDARD**  
1830 x 600 x 300mm  
72 x 23<sup>3</sup>/<sub>8</sub> x 11<sup>1</sup>/<sub>8</sub>"  
1 Units/Bundle  
6.02 Fc.Ft./Stone

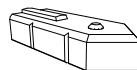

**CORNER 45°**  
1520 x 600 x 300mm  
59<sup>7</sup>/<sub>8</sub> x 23<sup>3</sup>/<sub>8</sub> x 11<sup>1</sup>/<sub>8</sub>"  
1 Units/Bundle  
7.04 Fc.Ft./Stone

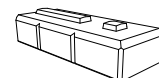

**CORNER 90°**  
1520 x 600 x 300mm  
59<sup>7</sup>/<sub>8</sub> x 23<sup>3</sup>/<sub>8</sub> x 11<sup>1</sup>/<sub>8</sub>"  
1 Units/Bundle  
7.04 Fc.Ft./Stone

**Notes: Special Order (SO).** Minimum quantities apply. **Lead time required. SOLD IN FULL BUNDLES ONLY** and is produced and sold on an required, refundable skid. **PALLETIZED 2 PIECES PER PALLET.** Closed-end coping units are closed on both ends so that they may be used as left or right units. 1/2 Standard units are slightly tapered and can be used to create a 45 foot radius. Refer to terms and conditions for placement rates. Unilock, through Risi Stone® Systems International, can provide preliminary site engineering for most commercial projects. Soil information, site drawings, and loading requirements are some of the information details required in order to provide this preliminary site engineering. All measurements are nominal. Contact Unilock for more information.

# DuraHold® Coping



## APPLICATIONS

Structural Walls

## APPEARANCE

Surface Texture - Standard

## CROSS SECTIONS

Cross Sections are available on Unilock's

Contractor website under Products:

[contractor.unilock.com](http://contractor.unilock.com)

## TECHNICAL INFORMATION

Conforms to ASTM C 1372

Eligible for LEED v4.1 credits

	COPING HALF	COPING STANDARD	COPING CLOSED-END
Bundle Type	SINGLE	SINGLE	SINGLE
Plant Produced	GORMLEY	GORMLEY	GORMLEY
Thickness (mm)	300 mm	300 mm	300 mm

FCFT PER	Stone	2.95	6.02	6.02
	Layer	2.95	6.02	6.02
	Bundle	2.95	6.02	6.02

PER BUNDLE	Layers	1.00	1.00	1.00
------------	--------	------	------	------

LNFT PER	Unit	3.00	6.00	6.02
	Bundle	3.00	6.00	6.02

UNITS PER	SqFt	0.34	0.17	0.17
	Layer	1	1	1
	Bundle	1.00	1.00	1.00

LBS PER	Units	780	1,560	1,560
	Layer	780	1,560	1,560
	Bundle	780	1,560	1,560

Colors	Reflectance	Stock	Stock	Stock
Natural	SR n/a SRI n/a	SO	SO	SO



NATURAL

SINGLE UNITS

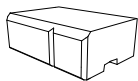

### COPING HALF

915 x 600 x 300mm  
36 x 23<sup>5</sup>/<sub>8</sub> x 11<sup>7</sup>/<sub>8</sub>"  
1 Units/Bundle  
2.95 Fc.Ft./Stone

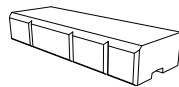

### COPING STANDARD

1830 x 600 x 300mm  
72 x 23<sup>5</sup>/<sub>8</sub> x 11<sup>7</sup>/<sub>8</sub>"  
1 Units/Bundle  
6.02 Fc.Ft./Stone

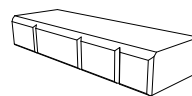

### CLOSED-END COPING

1830 x 600 x 300mm  
72 x 23<sup>5</sup>/<sub>8</sub> x 11<sup>7</sup>/<sub>8</sub>"  
1 Units/Bundle  
6.02 Fc.Ft./Stone

**Notes: Special Order (SO).** Minimum quantities apply. **Lead time required. SOLD IN FULL BUNDLES ONLY** and is produced and sold on an required, refundable skid. **PALLETIZED, 2 PIECES PER PALLET.** Closed-end coping units are closed on both ends so that they may be used as left or right units. 1/2 Standard units are slightly tapered and can be used to create a 45 foot radius. Refer to terms and conditions for placement rates. Unilock, through Risi Stone® Systems International, can provide preliminary site engineering for most commercial projects. Soil information, site drawings, and loading requirements are some of the information details required in order to provide this preliminary site engineering. All measurements are nominal. Contact Unilock for more information.

# DuraHold 2<sup>®</sup>



## APPLICATIONS

Structural Walls

## APPEARANCE

Surface Texture - Standard

## CROSS SECTIONS

Cross Sections are available on Unilock's

Contractor website under Products:

[contractor.unilock.com](http://contractor.unilock.com)

## TECHNICAL INFORMATION

Conforms to ASTM C 1372

Eligible for LEED v4.1 credits

	STANDARD	CORNER 90°	COPING	COPING CLOSED-END
Bundle Type	SINGLE	SINGLE	SINGLE	SINGLE
Plant Produced	GORMLEY	GORMLEY	GORMLEY	GORMLEY
Thickness (mm)	300 mm	300 mm	300 mm	300 mm

FCFT PER	Stone	6.02	4.17	6.02	6.02
	Layer	6.02	4.17	6.02	6.02
	Bundle	24.10	16.67	24.08	24.08

PER BUNDLE	Layers	4.00	4.00	4.00	4.00
------------	--------	------	------	------	------

LNFT PER	Unit	6.02	-	6.02	6.02
	Bundle	24.10	-	24.10	24.10

UNITS PER	SqFt	0.17	0.24	0.17	0.17
	Layer	1	1	1	1
	Bundle	4.00	4.00	4.00	4.00

LBS PER	Units	938	460	884	884
	Layer	938	460	884	884
	Bundle	3,752	1,840	3,536	3,536

Colors	Reflectance	Stock	Stock	Stock	Stock
Natural	SR n/a SRI n/a	SO	SO	SO	SO



NATURAL

SINGLE UNITS

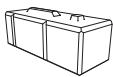

### CORNER 90°

900 x 360 x 300mm  
35 1/2 x 14 1/4 x 11 7/8"  
4 Units/Bundle  
4.17 Fc.Ft./Stone

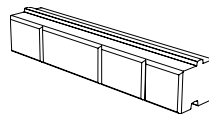

### STANDARD

1830 x 360 x 300mm  
72 x 14 1/4 x 11 7/8"  
4 Units/Bundle  
6.02 Fc.Ft./Stone

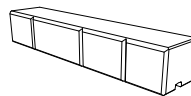

### COPING

1830 x 360 x 300 mm  
72 x 14 1/4 x 11 7/8"  
4 Units/Bundle  
6.02 Fc.Ft./Stone

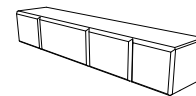

### CLOSED-END COPING

1830 x 360 x 300 mm  
72 x 14 1/4 x 11 7/8"  
4 Units/Bundle  
6.02 Fc.Ft./Stone

**Notes: Special Order (SO).** Minimum quantities apply. **Lead time required. SOLD IN FULL BUNDLES ONLY** and is produced and sold on an required, refundable skid. Must order corner as a left or right. Closed-end coping units are closed on both ends so that they may be used as left or right units. Unilock, through Risi Stone<sup>®</sup> Systems International, can provide preliminary site engineering for most commercial projects. Soil information, site drawings, and loading requirements are some of the information details required in order to provide this preliminary site engineering. All measurements are nominal. Contact Unilock for more information.

# Estate Wall™



## APPLICATIONS

Pillar, Steps, Outdoor Kitchen, Fire Feature, Water Feature, Structural Walls, Garden Wall, Seat Wall

## APPEARANCE

Surface Texture - Split

## CROSS SECTIONS

Cross Sections are available on Unilock's Contractor website under Products:

[contractor.unilock.com](http://contractor.unilock.com)

## TECHNICAL INFORMATION

Conforms to ASTM C 1372

Eligible for LEED v4.1 credits

	TAPERED SPLIT	CORNER SPLIT	COPING TAPERED
Bundle Type	RANDOM	SINGLE	SINGLE
Plant Produced	CHICAGO	CHICAGO	CHICAGO
Thickness (mm)	150 mm	150 mm	75 mm

FCFT PER	Stone	0.52	0.52	0.26
	Layer	6.25	4.17	2.34
	Bundle	31.25	20.83	18.74

PER BUNDLE	Layers	5.00	5.00	8.00
	Sections	4.00	4.00	3.00

LNFT PER	Unit	1.04	1.04	0.92
	Bundle	62.30	41.60	66.00

UNITS PER	SqFt	1.92	1.92	3.84
	Section	15.00	10.00	24.00
	Layer	12	8	9
	Bundle	60.00	40.00	72.00

LBS PER	Units	51	57	33
	Section	760	566	797
	Layer	608	453	299
	Bundle	3,040	2,264	2,392

Colors	Reflectance	Stock	Stock	Stock
Granite	SR n/a SRI n/a	✓	✓	✓
Sandstone	SR n/a SRI n/a	✓	✓	✓
Sierra	SR n/a SRI n/a	✓	✓	✓

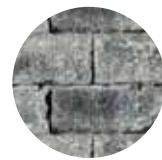

GRANITE



SANDSTONE



SIERRA

RANDOM BUNDLE

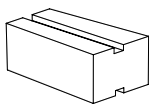

**LARGE TAPERED**  
380 x 230 x 150mm  
15 x 9 x 5 7/8"  
20 Units/Bundle  
.63 Fc.Ft./Stone

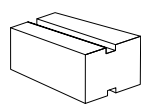

**MEDIUM TAPERED**  
320 x 230 x 150mm  
12 5/8 x 9 x 5 7/8"  
20 Units/Bundle  
.52 Fc.Ft./Stone

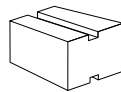

**SMALL TAPERED**  
250 x 230 x 150 mm  
9 7/8 x 9 x 5 7/8"  
20 Units/Bundle  
.42 Fc.Ft./Stone

SINGLE UNITS

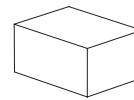

**CORNER SPLIT**  
320 x 230 x 150mm  
12 5/8 x 9 x 5 7/8"  
40 Units/Bundle  
.52 Sq.Ft./Stone

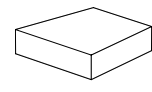

**COPING TAPERED**  
320 x 300 x 75mm  
12 5/8 x 11 7/8 x 3"  
72 Units/Bundle  
.26 Sq.Ft./Stone

**Notes:** 6" random wall bundles have convertible large units that can be used for corners or ending seat walls. End caps not sold separately. LedgeStone™ coping, Brussels Block® XL or Brussels Fullnose™ complement as a possible coping. All measurements are nominal. Contact Unilock for more information.

# Lineo™ Dimensional Stone



## APPLICATIONS

Pillar, Outdoor Kitchen, Fire Feature, Water Feature, Seat Wall, Garden Wall

## APPEARANCE

Surface Texture - Smooth

## CROSS SECTIONS

Cross Sections are available on Unilock's Contractor website under Products: [contractor.unilock.com](http://contractor.unilock.com)

## TECHNICAL INFORMATION

Conforms to ASTM C 1372  
Eligible for LEED v4.1 credits

		PILLAR / CORNER
Bundle Type	RANDOM	SINGLE
Plant Produced	MICHIGAN	MICHIGAN
Thickness (mm)	100 mm	100 mm

FCFT PER	Stone	0.50	0.33
	Layer	9.97	9.99
	Bundle	29.92	29.97

PER BUNDLE	Layers	3.00	3.00
------------	--------	------	------

LNFT PER	Unit	1.48	-
	Bundle	89.06	-

UNITS PER	SqFt	2.01	3.00
	Layer	20	30
	Bundle	60.00	90.00

LBS PER	Units	44	30
	Layer	881	893
	Bundle	2,643	2,679

Colors	Reflectance	Stock	Stock
Granite	SR.n/a SRI n/a	✓	✓
Graphite	SR.n/a SRI n/a	✓	✓
Sandstone	SR.n/a SRI n/a	✓	✓

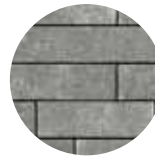

GRANITE



GRAPHITE



SANDSTONE

RANDOM BUNDLE

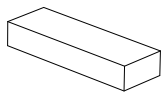

**XL RECTANGLE**  
600 x 200 x 100mm  
23<sup>3</sup>/<sub>8</sub> x 7<sup>7</sup>/<sub>8</sub> x 3<sup>3</sup>/<sub>8</sub>"  
15 Units/Bundle

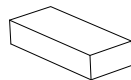

**LARGE RECTANGLE**  
500 x 200 x 100mm  
19<sup>3</sup>/<sub>4</sub> x 7<sup>7</sup>/<sub>8</sub> x 3<sup>3</sup>/<sub>8</sub>"  
15 Units/Bundle

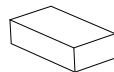

**RECTANGLE**  
400 x 200 x 100mm  
15<sup>3</sup>/<sub>4</sub> x 7<sup>7</sup>/<sub>8</sub> x 3<sup>3</sup>/<sub>8</sub>"  
15 Units/Bundle



**SMALL RECTANGLE**  
300 x 200 x 100mm  
11<sup>7</sup>/<sub>8</sub> x 7<sup>7</sup>/<sub>8</sub> x 3<sup>3</sup>/<sub>8</sub>"  
15 Units/Bundle

SINGLE UNIT

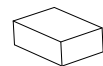

**PILLAR/CORNER**  
300 x 200 x 100mm  
11<sup>7</sup>/<sub>8</sub> x 7<sup>7</sup>/<sub>8</sub> x 3<sup>3</sup>/<sub>8</sub>"  
90 Units/Bundle  
.33 Fc.Ft./Stone

**Notes: SOLD IN FULL BUNDLES ONLY.** Spacing strips are shipped with random wall and pillar bundles to create even spacing between units. LedgeStone® or Unilock Natural Stone complement as possible coping options. All measurements are nominal. Contact Unilock for more information.



## APPLICATIONS

Pillar, Steps, Structural Walls, Garden Wall, Seat Wall

## APPEARANCE

Surface Texture - Split

## CROSS SECTIONS

Cross Sections are available on Unilock's Contractor website under Products:

[contractor.unilock.com](http://contractor.unilock.com)

## TECHNICAL INFORMATION

Conforms to ASTM C 1372

Eligible for LEED v4.1 credits

	TAPERED SPLIT	CORNER DOUBLE SPLIT	COPING
Bundle Type	DOUBLE UNIT	DOUBLE UNIT	DOUBLE UNIT
Plant Produced	MICHIGAN	MICHIGAN	MICHIGAN
Thickness (mm)	150 mm	150 mm	75 mm

FCFT PER	Stone	0.67	1.68	0.48
	Layer	6.67	6.72	2.91
	Bundle	20.00	20.17	20.34

PER BUNDLE	Layers	3.00	3.00	7.00
------------	--------	------	------	------

LNFT PER	Unit	1.33	-	2.00
	Bundle	40.00	-	84.00

UNITS PER	SqFt	1.50	0.59	2.06
	Layer	10	4	6
	Bundle	30.00	12.00	42.00

LBS PER	Units	86	110	65
	Layer	860	440	393
	Bundle	2,580	1,320	2,750

Colors	Reflectance	Stock	Stock	Stock
Beechwood	SR.n/a SRI n/a	✓	✓	✓
Charcoal	SR.n/a SRI n/a	✓	✓	✓
Granite	SR.n/a SRI n/a	✓	✓	✓
Sandstone	SR.n/a SRI n/a	✓	✓	✓



BEECHWOOD



CHARCOAL

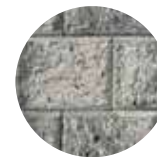

GRANITE



SANDSTONE

SINGLE UNITS

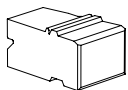

**TAPERED SPLIT**  
300 x 200 x 150mm  
11<sup>7</sup>/<sub>8</sub> x 7<sup>7</sup>/<sub>8</sub> x 5<sup>7</sup>/<sub>8</sub>"  
30 Units/Bundle  
.67 Fc.Ft./Stone

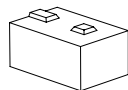

**CORNER**  
300 x 200 x 150mm  
11<sup>7</sup>/<sub>8</sub> x 7<sup>7</sup>/<sub>8</sub> x 5<sup>7</sup>/<sub>8</sub>"  
12 Units/Bundle  
1.68 Fc.Ft./Stone

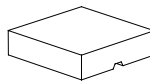

**COPING**  
300 x 300 x 75mm  
11<sup>7</sup>/<sub>8</sub> x 11<sup>7</sup>/<sub>8</sub> x 3"  
42 Units/Bundle  
.48 Fc.Ft./Stone

Notes: \* TAPERED WALL UNITS ARE DOUBLE UNITS AND ARE SOLD IN FULL BUNDLES ONLY. 12" Coping bundle has 16 units of closed-end coping (8 left and 8 right). Closed-end 12" coping is not sold separately. Maximum height - 36" (under optimum conditions). Higher walls can be achieved using geogrid reinforcement. The set back on Pisa wall is 3/4" every course or 1 1/2" every 2 courses. Min radius is 5 ft. Retaining wall engineering software is also available free of charge at [www.unilock.com](http://www.unilock.com). Walls greater than 4' in height require professional engineering. All measurements are nominal. Contact Unilock for more information.

# Pisa™ Smooth XL



## APPLICATIONS

Pillar, Steps, Garden Wall, Seat Wall

## APPEARANCE

Surface Texture - Smooth

## CROSS SECTIONS

Cross Sections are available on Unilock's Contractor website under Products: [contractor.unilock.com](http://contractor.unilock.com)

## TECHNICAL INFORMATION

Conforms to ASTM C 1372

Eligible for LEED v4.1 credits

	CORNER	XL TAPERED	COPING
Bundle Type	SINGLE	SINGLE	MULTI-COMPONENT
Plant Produced	MICHIGAN	MICHIGAN	MICHIGAN
Thickness (mm)	150 mm	150 mm	75 mm

FCFT PER	Stone	0.97	0.65	0.32
	Layer	11.63	5.17	1.94
	Bundle	46.52	20.67	15.50

PER BUNDLE	Layers	4.00	4.00	8.00
------------	--------	------	------	------

LNFT PER	Unit	-	-	1.31
	Bundle	-	-	62.99

UNITS PER	SqFt	1.03	1.55	3.10
	Layer	12	8	6
	Bundle	48.00	32.00	48.00

LBS PER	Units	58	78	47
	Layer	695	627	282
	Bundle	2,780	2,508	2,256

Colors	Reflectance	Stock	Stock	Stock
Charcoal	SR.n/a SRI n/a	✓	✓	✓
Fieldstone	SR.n/a SRI n/a	✓	✓	✓
Granite	SR.n/a SRI n/a	✓	✓	✓
Sandstone	SR.n/a SRI n/a	✓	✓	✓



CHARCOAL



FIELDSTONE



GRANITE



SANDSTONE

SINGLE UNITS

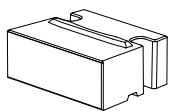

**XL TAPERED**  
400 x 300 x 150mm  
15 3/4 x 11 7/8 x 5 7/8"  
32 Units/Bundle  
.65 Fc.Ft./Stone

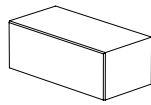

**CORNER**  
400 x 200 x 150mm  
15 3/4 x 7 7/8 x 5 7/8"  
48 Units/Bundle  
.97 Fc.Ft./Stone

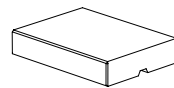

**COPING - MULTI-COMPONENT**  
400 x 325 x 75mm  
15 3/4 x 12 3/4 x 3"  
48 Units/Bundle  
.32 Fc.Ft./Stone

**Notes: SOLD IN FULL BUNDLES ONLY.** 12" Coping bundle has 48 units of coping (32 regular coping and 8 closed-end units per bundle). Closed-end 12" coping is not sold separately. Maximum height - 36" (under optimum conditions). Higher walls can be achieved using geogrid reinforcement. Min radius is 7.3' outside, with an 8mm (3 degree). Retaining wall engineering software is also available free of charge at [www.unilock.com](http://www.unilock.com). Walls greater than 4' in height require professional engineering. All measurements are nominal. Contact Unilock for more information.

# Quarry™ Smooth



## APPLICATIONS

Pillar, Outdoor Kitchen, Water Feature,  
Garden Wall, Seat Wall

## APPEARANCE

Surface Texture - Standard

## CROSS SECTIONS

Cross Sections are available on Unilock's  
Contractor website under Products:  
[contractor.unilock.com](http://contractor.unilock.com)

## TECHNICAL INFORMATION

Conforms to ASTM C 1372  
Eligible for LEED v4.1 credits

	WALL	CORNER
Bundle Type	RANDOM	SINGLE
Plant Produced	WISCONSIN	WISCONSIN
Thickness (mm)	114 mm	114 mm

FCFT PER	Stone	-	0.38
	Layer	5.63	6.08
	Bundle	33.75	18.24

PER BUNDLE	Layers	6.00	3.00
------------	--------	------	------

LNFT PER	Unit	-	-
	Bundle	-	-

UNITS PER	SqFt	-	2.63
	Layer	15.00	16.00
	Bundle	90.00	48.00

LBS PER	Units	-	40
	Layer	498	641
	Bundle	2,988	1,922

Colors	Reflectance	Stock	Stock
Charcoal	SR.n/a SRI n/a	✓	✓
Natural Grey	SR.n/a SRI n/a	✓	✓
Sandstone	SR.n/a SRI n/a	✓	✓



CHARCOAL



NATURAL GREY



SANDSTONE

RANDOM BUNDLE

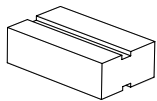

**15" LARGE TAPERED**  
380 x 230 x 114mm  
15 x 9 x 4 1/2"  
30 Units/Bundle  
.33 Fc.Ft./Stone

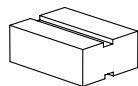

**12" MEDIUM TAPERED**  
305 x 230 x 114mm  
12 x 9 x 4 1/2"  
30 Units/Bundle  
.33 Fc.Ft./Stone

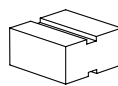

**9" SMALL TAPERED**  
230 x 230 x 114mm  
9 x 9 x 4 1/2"  
30 Units/Bundle  
.55 Fc.Ft./Stone

SINGLE UNITS

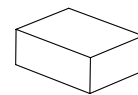

**CORNER**  
306.6 x 114 x 228.6mm  
12 x 9 x 4 1/2"  
48 Units/Bundle  
.38Fc.Ft./Stone

**Notes: SOLD IN FULL BUNDLES ONLY.** Corner and wall bundles are produced and sold on a required, refundable skid. Structural retaining walls greater than 2' high require professional engineering. Connector units provided with every bundle upon request. Use plastic connectors on set-back walls. Quarry tubing is added to orders when requested. Tubing may be used to set back walls. LedgeStone™, Olde Quarry™ Coping, Brussels Block™ XL, Brussels Fullnose™ or 6" x 12" Fullnose complement as a possible coping. All measurements are nominal. Contact Unilock for more information.



	WALL	CORNER	JUMPER	JUMPER CORNER
Bundle Type	RANDOM	RANDOM	RANDOM	SINGLE
Plant Produced	AYR	AYR	AYR	AYR
Thickness (mm)	57 mm	57 mm	114 mm	114 mm

FCFT PER	Stone	0.19	0.41	0.34	0.85
	Layer	3.04	4.05	3.43	6.77
	Bundle	24.30	16.21	13.73	13.55

PER BUNDLE	Layers	8.00	4.00	4.00	2.00
------------	--------	------	------	------	------

LNFT PER	Unit	1.02	-	-	0.41
	Bundle	130.69	-	-	6.56

UNITS PER	SqFt	5.27	2.47	2.91	1.18
	Layer	16.00	10.00	10.00	8.00
	Bundle	128.00	40.00	40.00	16.00

LBS PER	Units	16	29	41	61
	Layer	249	293	408	486
	Bundle	1,990	1,173	1,631	973

Colors	Reflectance	Stock	Stock	Stock	Stock
Buff	SR n/a SRI n/a	✓	✓	✓	✓
Coastal Slate	SR n/a SRI n/a	✓	✓	✓	✓

## APPLICATIONS

Pillar, Outdoor Kitchen, Water Feature, Steps, Fire Feature, Seat Wall, Garden Wall

## APPEARANCE

Surface Texture - Textured

## TECHNICAL INFORMATION

Conforms to ASTM C 1372

Eligible for LEED v4.1 credits



BUFF



COASTAL SLATE

CORNER BUNDLE

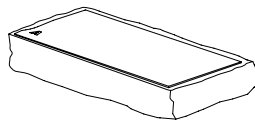

**LONG CORNER UNIT**  
450 x 230-250 x 57mm  
17 1/2 x 9-10 x 2 1/4"  
20 Units/Bundle

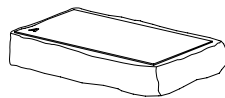

**SHORT CORNER UNIT**  
375 x 230-250 x 57mm  
14 1/2 x 9-10 x 2 1/4"  
20 Units/Bundle

JUMPER RANDOM BUNDLE



**Jumper UNIT 1**  
200 x 230-250 x 114mm  
8 x 9-10 x 4 1/2"  
16 Units/Bundle



**Jumper UNIT 2 / 3**  
300 x 230-250 x 114mm  
12 x 9-10 x 4 1/2"  
12 Units/Bundle

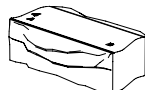

**Jumper UNIT 4**  
425 x 230-250 x 114mm  
17 x 9-10 x 4 1/2"  
12 Units/Bundle

JUMPER CORNER UNIT

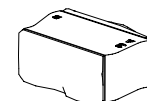

**JUMPER CORNER**  
450 x 230-250 x 114mm  
12 x 9-10 x 4 1/2"  
16 Units/Bundle

WALL RANDOM BUNDLE



**STANDARD UNIT 1**  
200 x 230-250 x 57mm  
8 x 9-10 x 2 1/4"  
32 Units/Bundle

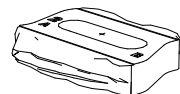

**STANDARD UNIT 2**  
300 x 230-250 x 57mm  
12 x 9-10 x 2 1/4"  
32 Units/Bundle



**STANDARD UNIT 3**  
300 x 230-250 x 57mm  
12 x 9-10 x 2 1/4"  
32 Units/Bundle

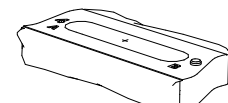

**STANDARD UNIT 4**  
425 x 230-250 x 57mm  
17 x 9-10 x 2 1/4"  
32 Units/Bundle

Notes: All measurements are nominal. Contact Unilock for more information.



## APPLICATIONS

Pillar, Outdoor Kitchen, Water Feature, Steps, Fire Feature, Seat Wall, Garden Wall

## APPEARANCE

Surface Texture - Textured

## TECHNICAL INFORMATION

Conforms to ASTM C 1372

Eligible for LEED v4.1 credits

	PILLAR UNIT	FIRE PIT RADIUS WALL
Bundle Type	SINGLE	SINGLE
Plant Produced	AYR	AYR
Thickness (mm)	114 mm	114 mm

FCFT PER	Stone	-	-
	Layer	-	-
	Bundle	-	-

PER BUNDLE	Layers	4.00	4.00
------------	--------	------	------

LNFT PER	Unit	-	-
	Bundle	-	-

UNITS PER	SqFt	-	-
	Layer	2.00	3.00
	Bundle	8.00	12.00

LBS PER	Units	220	117
	Layer	441	351
	Bundle	1,764	1,402

Colors	Reflectance	Stock	Stock
Buff	SR n/a SRI n/a	✓	✓
Coastal Slate	SR n/a SRI n/a	✓	✓



BUFF



COASTAL SLATE

PILLAR UNIT

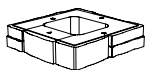

500 x 500 x 114mm  
20 x 20 x 4 1/2"  
Center opening 9 x 9"

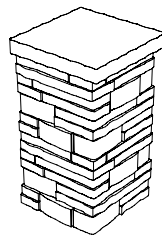

Completed Unit Shown  
Pillar cap Sold Separately

FIRE PIT RADIUS WALL UNIT

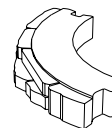

1,060 x 225 x 114mm  
41 3/4 x 8 7/8 x 4 1/2"  
12 Units/Bundle

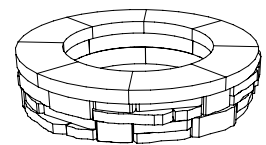

Fire Pit kit inserts and accessories sold separately.

**Ledgestone Fire Pit Coping**  
Sold Separately. See page 84

Notes: All measurements are nominal. Contact Unilock for more information.



## APPLICATIONS

Seat Wall, Garden Wall, Structural Wall, Steps

## APPEARANCE

Surface Texture - Smooth

## CROSS SECTIONS

Cross Sections are available on Unilock's

Contractor website under Products:

[contractor.unilock.com](http://contractor.unilock.com)

## TECHNICAL INFORMATION

Conforms to ASTM C 1372

Eligible for LEED v4.1 credits

	STANDARD CORNER	COPING
Bundle Type	SINGLE	SINGLE
Plant Produced	HARRISON	HARRISON
Thickness (mm)	180 mm	180 mm

FCFT PER	Stone	1.94	1.94
	Layer	7.75	7.75
	Bundle	23.25	23.25

PER BUNDLE	Layers	3.00	3.00
------------	--------	------	------

LNFT PER	Unit	3.28	3.28
	Bundle	39.37	39.37

UNITS PER	SqFt	0.52	0.52
	Layer	4.00	4.00
	Bundle	12.00	12.00

LBS PER	Units	257	257
	Layer	1,029	1,029
	Bundle	3,086	3,086

Colors	Reflectance	Stock	Stock
Fieldstone	SR n/a SRI n/a	✓	✓
Granite	SR n/a SRI n/a	✓	✓
Charcoal	SR n/a SRI n/a	✓	✓



CHARCOAL



FIELDSTONE



GRANITE

SINGLE UNITS

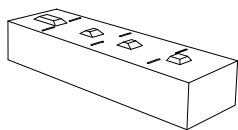

### STANDARD/CORNER

1000 x 290 x 180mm  
39 3/8 x 11 1/2 x 7"  
12 Units/Bundle  
1.94 Fc.Ft./Stone

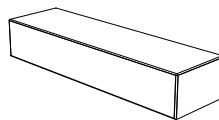

### COPING

1000 x 290 x 180mm  
39 3/8 x 11 1/2 x 7"  
12 Units/Bundle  
1.94 Fc.Ft./Stone

**Notes: SOLD IN FULL BUNDLES ONLY** and is produced and sold on a required, refundable skid. Coping units can be used to construct steps. Retaining wall engineering software is also available free of charge at [www.unilock.com](http://www.unilock.com). All measurements are nominal. Contact Unilock for more information.



	CORNER 90°	CORNER 45°	STANDARD 500	STANDARD 925	COPING	CE COPING
Bundle Type	SINGLE	SINGLE	SINGLE	SINGLE	SINGLE	SINGLE
Plant Produced	GORMLEY	GORMLEY	GORMLEY	GORMLEY	GORMLEY	GORMLEY
Thickness (mm)	185 mm	185 mm	185 mm	185 mm	185 mm	185 mm

FCFT PER	Stone	3.19	6.37	2.41	2.40	2.41	2.41
	Layer	6.37	12.74	4.81	2.40	4.81	4.81
	Bundle	19.11	19.11	14.43	7.21	14.43	14.43

PER BUNDLE	Layers	3.00	3.00	3.00	3.00	3.00	3.00
------------	--------	------	------	------	------	------	------

LNFT PER	Unit	-	-	4.00	4.00	3.95	3.95
	Bundle	-	-	24.00	12.00	23.70	23.70

UNITS PER	SqFt	0.31	0.16	0.42	0.42	0.42	0.42
	Layer	2	2	2	1	2	2
	Bundle	6.00	6.00	6.00	3.00	6.00	6.00

LBS PER	Units	570	525	570	1,140	570	570
	Layer	1,140	1,050	1,140	1,140	1,140	1,140
	Bundle	3,420	3,150	3,420	3,420	3,420	3,420

Colors	Reflectance	Stock	Stock	Stock	Stock	Stock	Stock
Natural	SR n/a SRI n/a	SO	SO	SO	SO	SO	✓

## APPLICATIONS

Structural Wall, Garden Wall, Steps

## APPEARANCE

Surface Texture - Split

## CROSS SECTIONS

Cross Sections are available on Unilock's Contractor website under Products:

[contractor.unilock.com](http://contractor.unilock.com)

## TECHNICAL INFORMATION

Conforms to ASTM C 1372

Eligible for LEED v4.1 credits



NATURAL

SINGLE UNITS

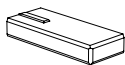

**CORNER 90° SPLIT**  
1100 x 500 x 185mm  
43 3/8 x 19 3/4 x 7 3/8"  
6 Units/Bundle  
3.19 Fc.Ft./Stone

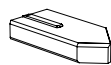

**CORNER 45° SPLIT**  
1100 x 500 x 185mm  
43 3/8 x 19 3/4 x 7 3/8"  
6 Units/Bundle  
6.37 Fc.Ft./Stone

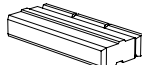

**STANDARD 500 SPLIT**  
1200 x 500 x 185mm  
47 1/4 x 19 3/4 x 7 3/8"  
6 Units/Bundle  
2.41 Fc.Ft./Stone

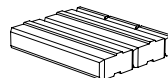

**STANDARD 925 SPLIT**  
1200 x 925 x 185mm  
47 1/4 x 36 1/2 x 7 3/8"  
3 Units/Bundle  
2.40 Fc.Ft./Stone

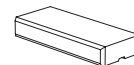

**COPING SPLIT**  
1200 x 500 x 185mm  
47 1/4 x 19 3/4 x 7 3/8"  
6 Units/Bundle  
2.41 Fc.Ft./Stone

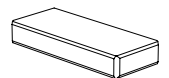

**CE COPING SPLIT**  
1200 x 500 x 185mm  
47 1/4 x 19 3/4 x 7 3/8"  
6 Units/Bundle  
2.41 Fc.Ft./Stone

**Notes: Special Order (SO).** Minimum quantities apply. **Lead time required.** **SOLD IN FULL BUNDLES ONLY** and is sold on a required, refundable skid. Stocked CE is sold by the piece. Coping units can be used to construct steps. Retaining wall engineering software is also available free of charge at [www.unilock.com](http://www.unilock.com). All measurements are nominal. Contact Unilock for more information.

# SienaStone® Smooth



## APPLICATIONS

Seat Wall, Structural Wall, Steps

## APPEARANCE

Surface Texture - Smooth

## CROSS SECTIONS

Cross Sections are available on Unilock's

Contractor website under Products:

[contractor.unilock.com](http://contractor.unilock.com)

## TECHNICAL INFORMATION

Conforms to ASTM C 1372

Eligible for LEED v4.1 credits

	CORNER 375	STANDARD 375	48" COPING	48" COPING CLOSED-END R & L
Bundle Type	SINGLE	SINGLE	SINGLE	SINGLE
Plant Produced	GORMLEY	GORMLEY	GORMLEY	GORMLEY
Thickness (mm)	180 mm	180 mm	180 mm	180 mm

FCFT PER	Stone	5.24	2.33	2.33	2.33
	Layer	5.24	6.98	6.98	6.98
	Bundle	15.71	20.93	20.93	20.93

PER BUNDLE	Layers	3.00	3.00	3.00	3.00
------------	--------	------	------	------	------

LNFT PER	Unit	-	4.00	4.00	4.00
	Bundle	-	36.00	36.00	36.00

UNITS PER	SqFt	0.19	0.43	0.43	0.43
	Layer	1	3	3	3
	Bundle	3.00	9.00	9.00	9.00

LBS PER	Units	648	394	395	395
	Layer	648	1,182	1,185	1,185
	Bundle	1,944	3,546	3,555	3,555

Colors	Reflectance	Stock	Stock	Stock	Stock
Granite	SR.n/a SRI n/a	✓	✓	✓	✓
Safari	SR.n/a SRI n/a	SO	SO	SO	SO



GRANITE



SAFARI

SINGLE UNITS

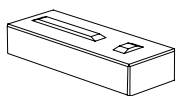

**CORNER 375**  
975 x 375 x 180mm  
38 1/2 x 14 7/8 x 7"  
3 Units/Bundle  
5.24 Fc.Ft./Stone

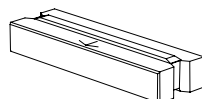

**STANDARD 375**  
1200 x 375 x 180mm  
47 1/4 x 14 7/8 x 7"  
9 Units/Bundle  
2.33 Fc.Ft./Stone

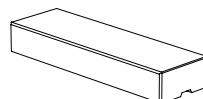

**48" COPING**  
1200 x 383 x 180mm  
47 1/4 x 15 x 7"  
9 Units/Bundle  
2.33 Fc.Ft./Stone

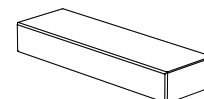

**48" COPING CLOSED-END R OR L**  
1200 x 383 x 180mm  
47 1/4 x 15 x 7"  
9 Units/Bundle  
2.33 Fc.Ft./Stone

**Notes: Special Order (SO)** items may have minimum order quantities & extended lead time required. Sold on a required, refundable skid. **CLOSE-END COPING LEFT AND RIGHT ARE SOLD SEPARATELY.** All measurements are nominal. Contact Unilock for more information.

# SienaStone® Smooth Step



## APPLICATIONS

Steps

## APPEARANCE

Surface Texture - Smooth

## CROSS SECTIONS

Cross Sections are available on Unilock's

Contractor website under Products:

[contractor.unilock.com](http://contractor.unilock.com)

## TECHNICAL INFORMATION

Conforms to ASTM C 1372

Eligible for LEED v4.1 credits

	48" STEP	72" STEP
Bundle Type	SINGLE	SINGLE
Plant Produced	GORMLEY	GORMLEY
Thickness (mm)	180 mm	180 mm

FCFT PER	Stone	2.33	3.49
	Layer	4.65	3.49
	Bundle	13.95	6.97

PER BUNDLE	Layers	3.00	2.00
------------	--------	------	------

LNFT PER	Unit	4.00	5.91
	Bundle	24.00	11.81

UNITS PER	SqFt	0.43	0.29
	Layer	2	1
	Bundle	6.00	2.00

LBS PER	Units	540	798
	Layer	1,081	798
	Bundle	3,242	1,596

Colors	Reflectance	Stock	Stock
Dusk	SR.n/a SRI n/a	✓	SO
Granite	SR.n/a SRI n/a	✓	SO
Charcoal	SR.n/a SRI n/a	✓	SO
Safari	SR.n/a SRI n/a	✓	SO



DUSK

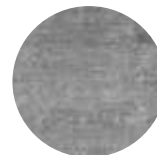

GRANITE

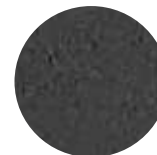

CHARCOAL



SAFARI

SINGLE UNIS

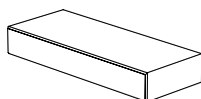

### 48" STEP

1200 x 500 x 180mm  
47 1/4 x 19 3/4 x 7"  
6 Units/Bundle  
2.33 Fc.Ft./Stone

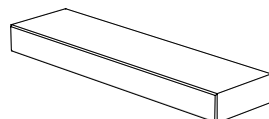

### 72" STEP

1800 x 500 x 180mm  
70 7/8 x 19 3/4 x 7"  
2 Units/Bundle  
3.49 Fc.Ft./Stone

**Notes:** Special Order (SO) items may have minimum order quantities & extended lead time required. Product is sold on a required, refundable skid. All measurements are nominal. Contact Unilock for more information.

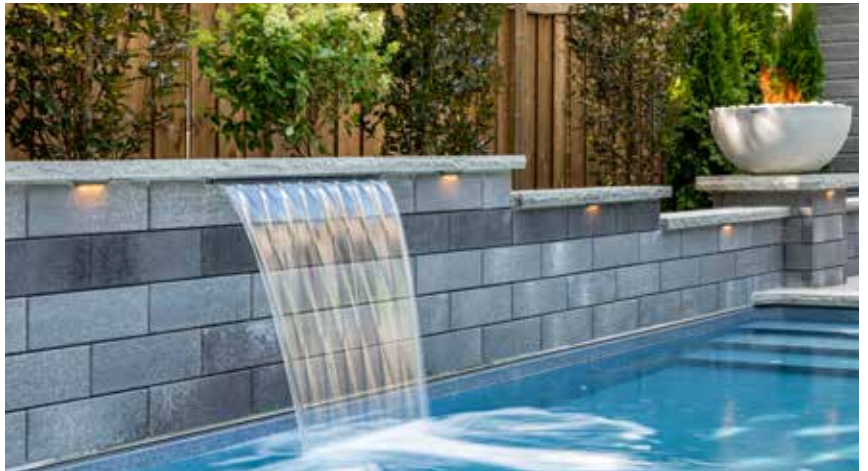

FASCIA PANELS  
FINISHES



SMOOTH



PITCHED



UMBRIANO



SUBWAY

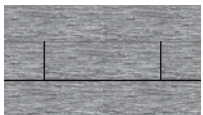

LAVANO



1/2 Running Bond

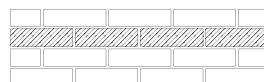

1/2 Running Bond with Linear Accents



1/2 Running Bond with Random Accents

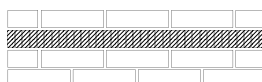

1/2 Running Bond with Paver Accents

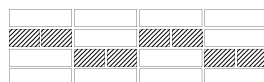

Mixed Bond



1/3 Running Bond



## U-CARA RETAINING WALL GEOGRID SECTION

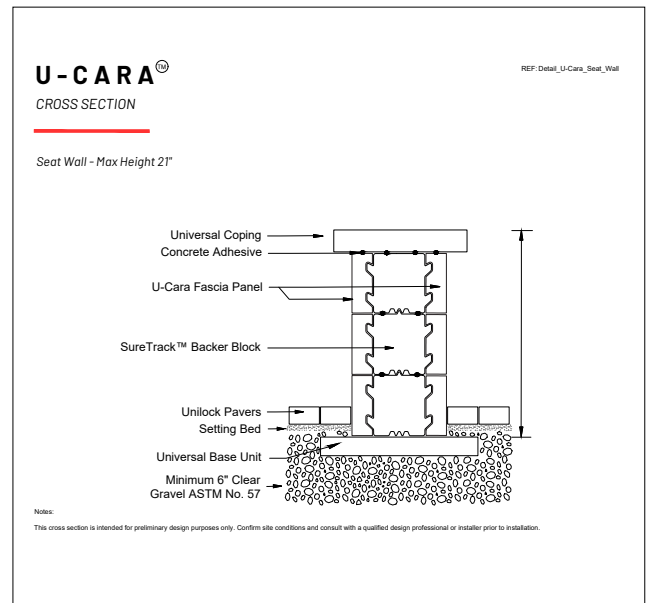
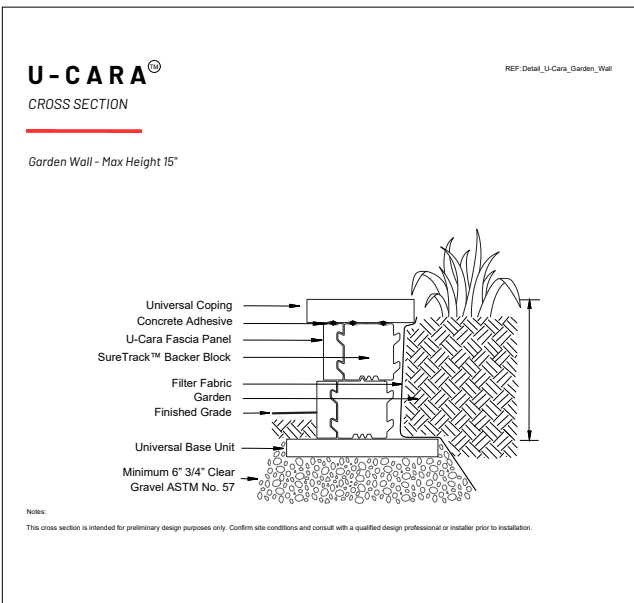
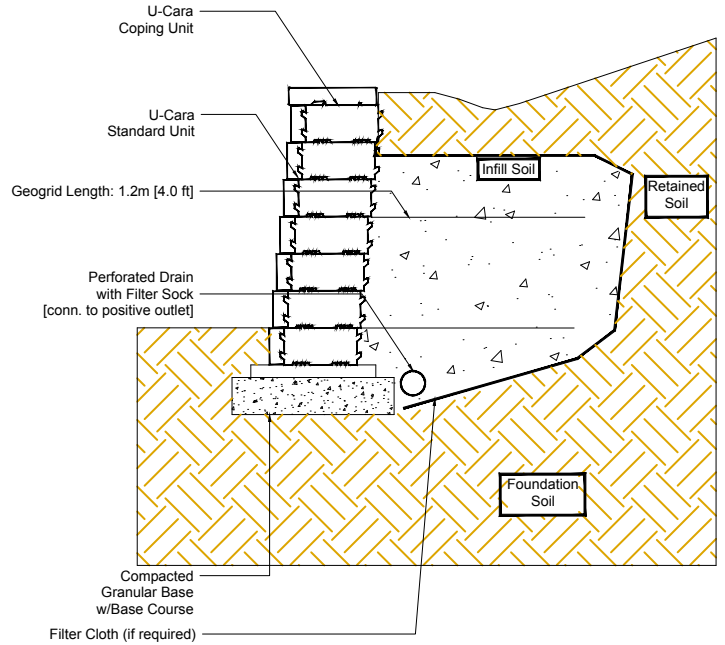

	STANDARD 6" SMOOTH	CLOSED-END 6" SMOOTH	STANDARD 6" UMBRIANO	CLOSED-END 6" UMBRIANO	STANDARD 6" PITCHED	CLOSED-END 6" PITCHED
Bundle Type	SINGLE	SINGLE	SINGLE	SINGLE	SINGLE	SINGLE
Plant Produced	MICHIGAN	MICHIGAN	GEORGETOWN	GEORGETOWN	MICHIGAN	MICHIGAN
Thickness (mm)	150 mm	150 mm	150 mm	150 mm	150 mm	150 mm

FCFT PER	Stone	0.73	1.29	0.73	1.29	0.73	1.29
	Layer	10.25	9.03	10.25	9.03	10.25	9.03
	Bundle	61.52	54.18	61.52	54.18	61.52	54.18

PER BUNDLE	Layers	6.00	6.00	6.00	6.00	6.00	6.00
------------	--------	------	------	------	------	------	------

LNFT PER	Unit	1.54	2.50	1.54	2.50	1.54	2.50
	Bundle	129.50	104.86	129.50	104.86	129.50	104.86

UNITS PER	SqFt	1.37	0.78	1.37	0.78	1.37	0.78
	Layer	14	7	14	7	14	7
	Bundle	84.00	42.00	84.00	42.00	84.00	42.00

LBS PER	Units	18	30	18	30	21	34
	Layer	252	207	252	207	291	236
	Bundle	1,513	1,240	1,513	1,240	1,745	1,415

Colors	Reflectance	Stock	Stock	Stock	Stock	Stock	Stock
Dark Charcoal	SR.n/a SRI n/a	✓	✓	-	-	-	-
Fossil	SR.n/a SRI n/a	✓	✓	-	-	✓	✓
Granite Fusion	SR.n/a SRI n/a	✓	✓	-	-	✓	✓
Opal Blend	SR.n/a SRI n/a	✓	✓	-	-	-	-
Indiana Buff	SR.n/a SRI n/a	✓	✓	-	-	-	-
Sierra *	SR.n/a SRI n/a	✓	✓	-	-	✓	✓
Sterling	SR.n/a SRI n/a	SO	SO	-	-	-	-
French Grey	SR.n/a SRI n/a	-	-	✓	✓	-	-
Grenada White	SR.n/a SRI n/a	-	-	✓	✓	-	-
Midnight Sky	SR.n/a SRI n/a	-	-	✓	✓	-	-
Summer Wheat	SR.n/a SRI n/a	-	-	✓	✓	-	-
Winter Marvel	SR.n/a SRI n/a	-	-	✓	✓	-	-

\*While supplies last

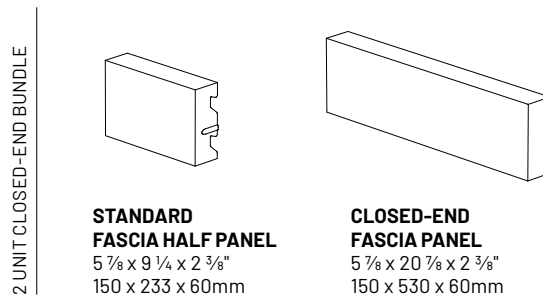
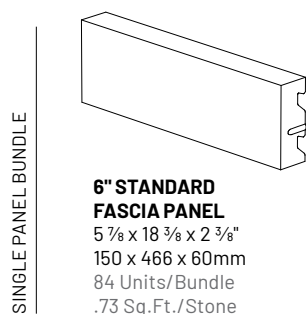

Close-End panels:  
 24 rights/18 lefts per pallet

Notes: Special Order (SO) items may have minimum order quantities & extended lead time required. SOLD IN FULL BUNDLES ONLY and is produced and sold on a required, refundable skid. Important: A urethane rubber paver mat must be used to prevent scuffing when compacting. All measurements are nominal. Contact Unilock for more information.



## APPLICATIONS

Pillar, Outdoor Kitchen, Water Feature, Fire Feature, Walls up to 3' in Height: Seat Wall, Garden Wall, Retaining Walls, Structural Wall

## APPEARANCE

Surface Texture - Smooth, Standard, Umbriano Mottled and Pitched

## TECHNICAL INFORMATION

Conforms to ASTM C1372

Eligible for LEED v4.1 credits

	LAVANO STANDARD	LAVANO CLOSED END	SUBWAY STANDARD	SUBWAY CLOSED END
Bundle Type	SINGLE	BUNDLE	SINGLE	BUNDLE
Plant Produced	MICHIGAN	MICHIGAN	MICHIGAN	MICHIGAN
Thickness (mm)	150 mm	150 mm	150 mm	150 mm

FCFT PER	Stone	0.73	1.29	0.73	1.29
	Layer	10.25	9.03	10.25	9.03
	Bundle	61.52	54.18	61.52	54.18

PER BUNDLE	Layers	6.00	6.00	6.00	6.00
------------	--------	------	------	------	------

LNFT PER	Unit	1.54	2.50	1.54	2.50
	Bundle	129.50	104.86	129.50	104.86

UNITS PER	SqFt	1.37	0.78	1.37	0.78
	Layer	14	7	14	7
	Bundle	84.00	42.00	84.00	42.00

LBS PER	Units	18	30	18	30
	Layer	252	207	252	207
	Bundle	1,513	1,240	1,513	1,240

Colors	Reflectance	Stock	Stock	Stock	Stock
Granite Fusion	SR n/a SRI n/a	✓	✓	-	-
Fossil	SR n/a SRI n/a	✓	✓	-	-
Indiana Buff	SR n/a SRI n/a	✓	✓	✓	✓
Dark Charcoal	SR n/a SRI n/a	-	-	✓	✓

SINGLE PANEL BUNDLE

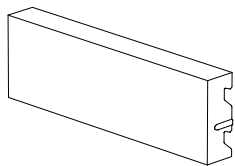

**STANDARD FASCIA PANEL**  
 5 7/8 x 18 3/8 x 2 3/8"  
 150 x 466 x 60mm  
 84 Units/Bundle  
 .73 Fc.Ft./Stone

2 UNIT CLOSED-END BUNDLE

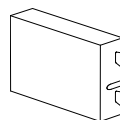

**HALF FASCIA PANEL**  
 5 7/8 x 9 1/4 x 2 3/8"  
 150 x 233 x 60mm

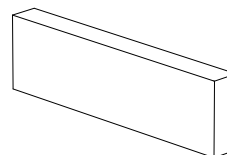

**CLOSED-END FASCIA PANEL**  
 5 7/8 x 20 7/8 x 2 3/8"  
 150 x 530 x 60mm

Notes: **SOLD IN FULL BUNDLES.** Produced and sold on a required refundable skids. Sure Track Large Backer Units when used as corners in a pillar application, can achieve 42 FFT/bundle or .757 FFT/unit.

SMOOTH PANELS



DARK CHARCOAL



FOSSIL



GRANITE FUSION



INDIANA BUFF



OPAL BLEND

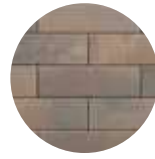

SIERRA  
*(while supplies last)*



STERLING  
*(Special Order)*

UMBRIANO® PANELS



FRENCH GREY



GRENADA WHITE



MIDNIGHT SKY



SUMMER WHEAT



WINTER MARVEL

PITCHED PANELS



FOSSIL



GRANITE FUSION



SIERRA  
*(while supplies last)*

SUBWAY PANELS



DARK CHARCOAL

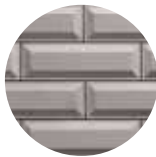

INDIANA BUFF

LAVANO PANELS

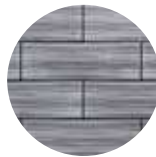

GRANITE FUSION

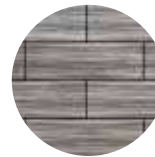

FOSSIL

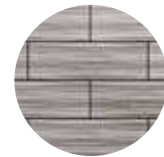

INDIANA BUFF

# U-Cara® Backer



	LARGE CORNER BACKER	STANDARD BACKER	UNIVERSAL BASE
Bundle Type	SINGLE	SINGLE	SINGLE
Plant Produced	MICHIGAN	MICHIGAN	MICHIGAN
Thickness (mm)	150 mm	150 mm	150 mm

FCFT PER	Stone	0.28	0.32	-
	Layer	3.96	11.30	-
	Bundle	15.82	33.91	-

PER BUNDLE	Layers	4.00	3.00	9.00
------------	--------	------	------	------

LNFT PER	Unit	-	0.67	1.17
	Bundle	-	69.99	63.00

UNITS PER	SqFt	3.54	3.10	-
	Layer	14	35	6
	Bundle	56.00	105.00	54.00

LBS PER	Units	36	23	46
	Layer	503	812	278
	Bundle	2,012	2,437	2,502

Colors	Reflectance	Stock	Stock	Stock
Natural	SR n/a SRI n/a	✓	✓	✓



NATURAL

COMPONENTS

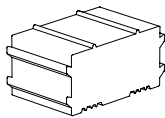

**SURE TRACK  
LARGE CORNER BACKER**  
150 x 175 x 294mm  
5 7/8 x 6 7/8 x 11 5/8"  
56 Units/Bundle

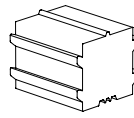

**SURE TRACK  
STANDARD BACKER**  
150 x 150 x 195mm  
5 7/8 x 5 7/8 x 7 7/8"  
105 Units/Bundle

RECOMMENDED  
BASE UNIT

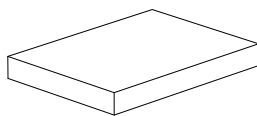

**UNIVERSAL BASE**  
482 x 355 x 55mm  
19 x 14 x 2 1/4"  
54 Units/Bundle

EXTRA  
COMPONENTS



**SURE TRACK  
CORNER INSERT**  
L = 2"  
50mm  
40pcs/bag

Notes: Sold in full pallets only on a refundable skid. All measurements are nominal. Contact Unilock for more information.

The U-Cara Modular System offers a variety of aluminum frames that can be mixed and matched to construct vertical features like grill islands. Speak to your contractor to select a design and a U-Cara fascia panel finish to suit your project.

With the U-Cara Modular System you can build Grill Islands, Bars, Back splashes, Fire Places and Pillars.

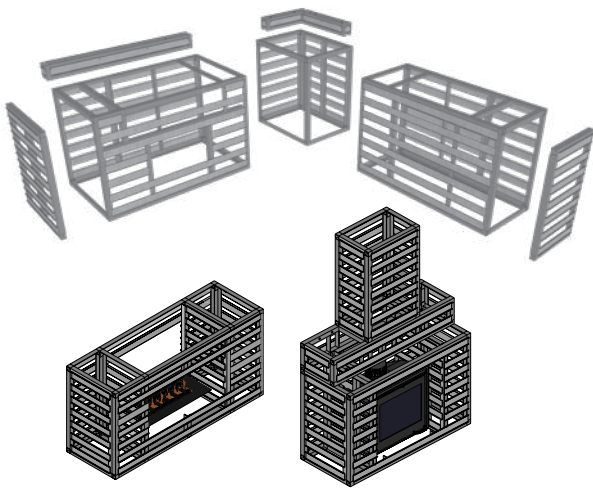

No.	MODEL	Description
UCARA000001	URS	UCARA RAIL (10/PACK)
UCARA000003	URS	ALIGNMENT BARS 39" (10/PACK)
UCARA000007	UL-OSK	CABINET DEPTH CHANGE KIT
UCARA000009	UL-FIR	U-CARA FIREPLACE
UCARA000010	UL-FIR-M	U-CARA FIREPLACE MANTLE
UCARA000016	UL-FIR-MW	U-CARA FIREPLACE MANTLE WIDE UNIT
UCARA000017	UL-FIR-CH	U-CARA FIREPLACE CHIMNEY UNIT
UCARA000018	UL-FIR-CH-MW	U-CARA FIREPLACE CHIMNEY WIDE UNIT
UCARA000019	UL-FIR-RTN	U-CARA FIREPLACE RETURN
UCARA000020	UL-FIR-RTN-OS	U-CARA FIREPLACE RETURN OVERSIZED
UCARA001000	UL-GC	UNIVERSAL GRILL CABINET (FITS 36"-42" GRILL)
UCARA002000	UL-BC	BASE CABINET (FITS FIRE TABLE OR FRIDGE)
UCARA003000	UL-CC	CORNER CABINET 27.5" X 27.5"
UCARA003001	UL-CC-OS	CORNER CABINET 27.5" X 36.5" OS
UCARA003002	UL-CC-BP	CORNER CABINET BACK PANEL
UCARA004000	UL-ECK	END CLAD KIT 27.5"
UCARA004001	UL-ECK-OS	END CLAD KIT 36.5" OS
UCARA005000	UL-BS	BACKSPLASH-GRILL/BASE UNIT 64½"
UCARA005001	UL-BS-CC	BACKSPLASH CORNER CABINET
UCARA005002	UL-BS-CC-OS	BACKSPLASH CORNER CABINET OS
UCARA006000	UL-DD	STAINLESS DOUBLE ACCESS DOORS 27"
UCARA007000	UL-PU	PILLAR UNIT (18 ¾" X 18 ¾")
UCARA001002	UL-GC-36	UNIVERSAL GRILL CABINET (FITS 36"-42" GRILL)
UCARA002001	UL-BC-36	BASE CABINET (FITS FIRE TABLE OR FRIDGE)
UCARA003004	UL-CC-OS-36	CRNR CABINET 27.5X36.5 OS
UCARA003005	UL-CC-36	CORNER CABINET 27.5X27.5
UCARA004002	UL-ECK-36	END CLAD KIT 27.5"
UCARA004003	UL-ECK-OS-36	END CLAD KIT 36.5" OS



The U-Cara Wall Mount System allows you to put the finishing touches on your project by cladding existing structures like unsightly exposed foundation areas or concrete steps with U-Cara fascia panels.



U-CARA ALIGNMENT BAR:  
39" LENGTH - SOLD IN PACKS OF 10 PIECES

U-CARA RAILS:  
8' LENGTH - SOLD IN PACKS OF 10 PIECES

# U-Cara® Wall Mount System Installation

## Alignment Bar

- | 38-5/8" tall (up to 7 courses of 6" fascia panels)
- | Pre-punched to accommodate both 3" & 6" panels
- | Eliminates the need to measure for rail spacing
- | Speeds up installation
- | 10 per bundle



## Horizontal Rail

- | 8' long with pre-punched holes every 8"
- | Heavy duty galvanized steel
- | 10 per bundle



## U-Cara Fascia Panels

- | EnduraColor Technology
- | Available in 4 different finishes and several colors
- | Apply adhesive and hang on wall mount system



### Wood Substrate Application

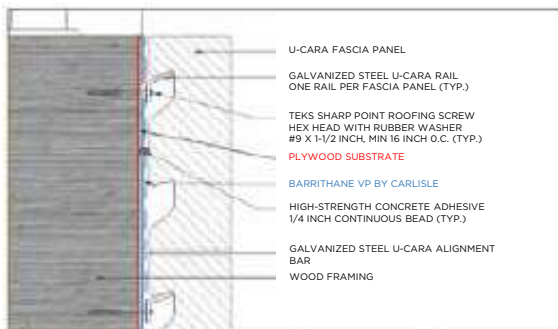

- Carlisle Barrithane VP**
- | Damp surface tolerant
  - | Immediately rain resistant
  - | Single coat application
  - | Apply as low as 15° F



- Teks Sharp Point Roofing Screw #12 x 1-1/2"**
- | Hex head
  - | Rubber washer
  - | Corrosion resistant coating

### Concrete Substrate Application

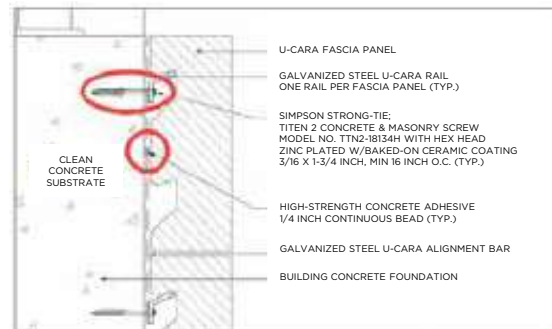

- Simpson Strong-Tie Titen 2 Hex Head 3/16" x 1-3/4"**
- | Improved thread design
  - | Increased load capacity
  - | Reduced snapping
  - | 450+ pound tension load
  - | 275+ pound shear load

# U-Cara® Wall Mount System Installation



**Step 1:** Determine finished top height, mark with chalk line. Align orange painted end of alignment bar with chalk line.

Alignment bars should be placed 16" in from end of horizontal rail, and every 32".

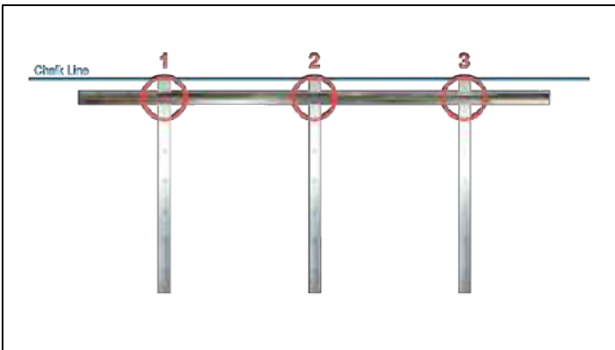

**Step 2:** Fasten both horizontal rail and alignment bars to substrate at points 1, 2, and 3; ensuring the rail is level.

The first four screws are the most important, as they will establish your grid pattern for all your horizontal rails in this section.

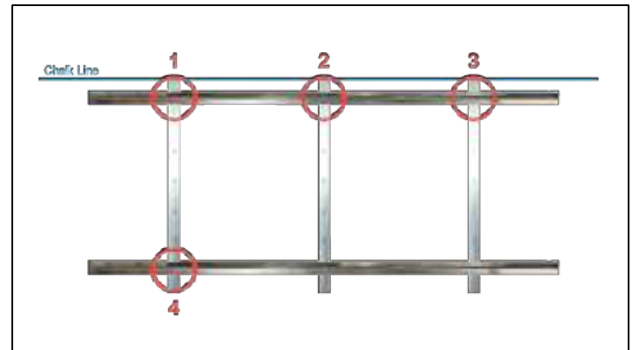

**Step 3:** Fasten the bottom horizontal rail and alignment bar at point 4; use a level or a square to ensure alignment bar is plumb

You have now established your grid pattern for the rest of your horizontal rails in this section.

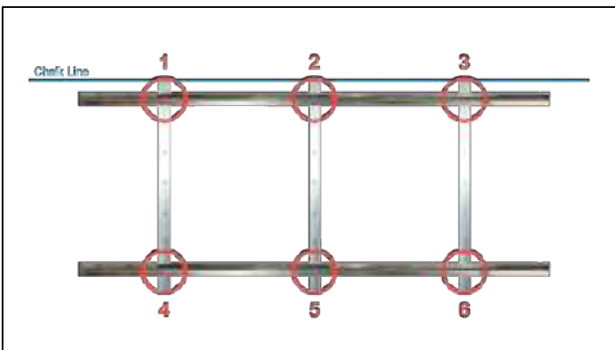

**Step 4:** Fasten the bottom horizontal rail and alignment bars at points 5 and 6.

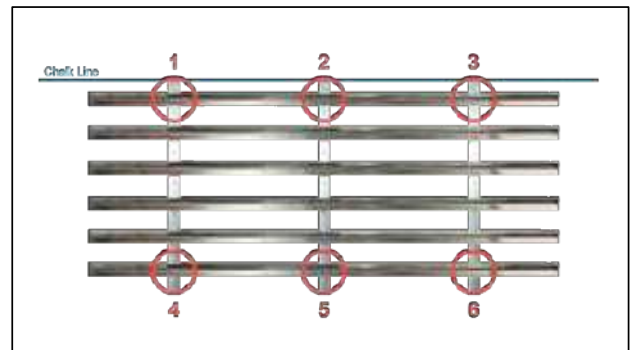

**Step 5:** Fasten remaining horizontal rails.

All horizontal rail should be fastened to substrate every 16" and on both ends.

# Brussels Fullnose™



## APPLICATIONS

Steps, Pillar, Water Feature, Pool Coping, Wall Coping, Fire Feature

## APPEARANCE

Surface Texture - Textured

## TECHNICAL INFORMATION

Conforms to ASTM C 936

Eligible for LEED v4.1 credits

	STANDARD
Bundle Type	SINGLE
Plant Produced	MICHIGAN
Thickness (mm)	70 mm

FCFT PER	Stone	-
	Layer	-
	Bundle	-

PER BUNDLE	Layers	8.00
------------	--------	------

LNFT PER	Unit	0.50
	Bundle	96.00

UNITS PER	SqFt	-
	Layer	24
	Bundle	192.00

LBS PER	Units	16
	Layer	384
	Bundle	3,075

Colors	Reflectance	Stock
Charcoal	SR .12 SRI 9	✓
Coffee Creek	SR n/a SRI n/a	✓
Limestone	SR n/a SRI n/a	✓
Sandstone	SR .41 SRI 46	✓
Sierra	SR. n/a SRI n/a	✓



DARK CHARCOAL



COFFEE CREEK



LIMESTONE



SANDSTONE



SIERRA

SINGLE UNIT

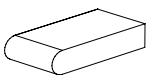

**6 x 12**  
150 x 300 x 70mm  
5 7/8 x 11 7/8 x 2 3/4"  
192 Units/Bundle

**Notes: SOLD IN FULL BUNDLES ONLY.** Units can be adhered to pool edge using Unilock Concrete Adhesive, or with mortar. Always observe proper construction techniques when adhering pavers to a surface. Consult your local pool contractors for installation specifics.



## APPLICATIONS

Pillar, Water Feature, Pool Coping, Fire Feature, Wall Coping, Steps

## APPEARANCE

Surface Texture - Smooth

## TECHNICAL INFORMATION

Conforms to ASTM C 1372

Eligible for LEED v4.1 credits

	CHAMFERED 36 x 19	FULLNOSE 36 x 19	CHAMFERED 24 x 14	FULLNOSE 24 x 14
Bundle Type	SINGLE	SINGLE	SINGLE	SINGLE
Plant Produced	ONTARIO	ONTARIO	ONTARIO	ONTARIO
Thickness (mm)	60 mm	60 mm	60 mm	60 mm

FCFT PER	Stone	0.58	0.58	0.39	0.39
	Layer	1.16	1.16	1.55	1.55
	Bundle	6.96	6.96	9.30	9.30

PER BUNDLE	Layers	6.00	6.00	6.00	6.00
------------	--------	------	------	------	------

LNFT PER	Unit	2.96	2.96	1.97	1.97
	Bundle	35.46	35.46	47.24	47.24

UNITS PER	SqFt	1.72	1.72	-	-
	Layer	2.00	2.00	4.00	4.00
	Bundle	12.00	12.00	24.00	24.00

LBS PER	Units	129	129	63	63
	Layer	258	258	252	252
	Bundle	1,547	1,547	1,510	1,510

Colors	Reflectance	Stock	Stock	Stock	Stock
Sterling	SR.n/a SRI n/a	✓	✓	✓	✓
Opal Blend	SR.n/a SRI n/a	✓	✓	✓	✓
Indiana Buff	SR.n/a SRI n/a	✓	✓	✓	✓
Dark Charcoal	SR.n/a SRI n/a	✓	✓	✓	✓
Platinum	SR.n/a SRI n/a	-	-	✓	✓
Granite Fusion	SR.n/a SRI n/a	-	-	✓	✓
Oat Beige	SR.n/a SRI n/a	-	-	✓	✓



OAT BEIGE



STERLING



INDIANA BUFF



OPAL BLEND



PLATINUM

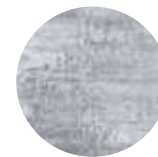

GRANITE FUSION



DARK CHARCOAL

SINGLE UNITS

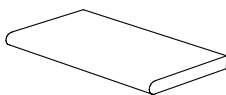

**36 x 19 FULLNOSE**  
900 x 485 x 60 mm  
35½ x 19 x 2⅜  
12 Units/Bundle  
.58 Fc.Ft/Stone

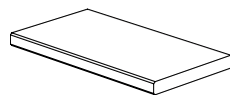

**36 x 19 CHAMFERED**  
900 x 485 x 60 mm  
35½ x 19 x 2⅜  
12 Units/Bundle  
.58 Fc.Ft/Stone

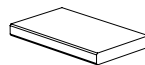

**24 x 14 CHAMFERED**  
600 x 360 x 60 mm  
23 ⅝ x 14 ⅛ x 2 ⅜  
24 Units/Bundle  
.39 Fc.Ft/Stone

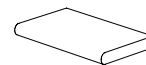

**24 x 14 FULLNOSE**  
600 x 360 x 60 mm  
23 ⅝ x 14 ⅛ x 2 ⅜  
24 Units/Bundle  
.39 Fc.Ft/Stone

**Notes: SOLD IN FULL BUNDLES ONLY** and is produced and sold on a required, refundable skid. Units can be adhered to pool edge using concrete adhesive, or with mortar. Always observe proper construction techniques when adhering pavers to a surface. Consult your local pool contractors for installation specifics. All measurements are nominal. Contact Unilock for more information.



### APPLICATIONS

Pillar, Water Feature, Pool Coping, Fire Feature, Wall Coping, Steps

### APPEARANCE

Surface Texture - Standard / Smooth

### TECHNICAL INFORMATION

Conforms to ASTM C 1372  
Eligible for LEED v4.1 credits

	COPING / STEP
Bundle Type	SINGLE
Plant Produced	MICHIGAN
Thickness (mm)	70 mm

FCFT PER	Stone	0.36
	Layer	2.18
	Bundle	17.44

PER BUNDLE	Layers	8.00
------------	--------	------

LNFT PER	Unit	1.58
	Bundle	75.90

UNITS PER	SqFt	2.75
	Layer	6
	Bundle	48.00

LBS PER	Units	57
	Layer	343
	Bundle	2,747

Colors	Reflectance	Stock
Natural	SR.n/a SRI n/a	✓
Sandstone	SR.n/a SRI n/a	✓
Dark Charcoal	SR.n/a SRI n/a	✓



LIGHT GREY



SANDSTONE



DARK CHARCOAL

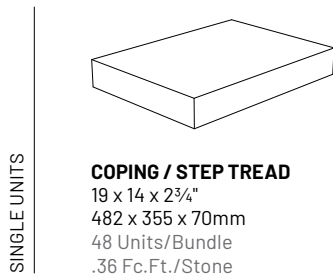

SINGLE UNITS

**COPING / STEP TREAD**  
19 x 14 x 2¾"  
482 x 355 x 70mm  
48 Units/Bundle  
.36 Fc.Ft./Stone

**Notes: SOLD IN FULL BUNDLES ONLY.** Two (2) End Coping units per Layer (1 Left & 1 Right). All measurements are nominal. Contact Unilock for more information.



### APPLICATIONS

Pillar, Outdoor Kitchen, Water Feature, Fire Feature, Structural Wall, Steps

### APPEARANCE

Surface Texture - Textured

### TECHNICAL INFORMATION

Conforms to ASTM C1776

Eligible for LEED v4.1 credits

	FULLNOSE COPING	STANDARD COPING	STANDARD CLOSED-END	LARGE COPING	LARGE CLOSED-END
Bundle Type	SINGLE	SINGLE	SINGLE	SINGLE	SINGLE
Plant Produced	CHICAGO	CHICAGO	CHICAGO	CHICAGO	CHICAGO
Thickness (mm)	60 mm	70 mm	70 mm	70 mm	70 mm

FCFT PER	Stone	0.39	0.46	0.46	0.57	0.57
	Layer	0.39	1.38	1.38	1.72	1.72
	Bundle	5.12	5.52	5.52	6.87	6.87

PER BUNDLE	Layers	13.00	4.00	4.00	4.00	4.00
------------	--------	-------	------	------	------	------

LNFT PER	Unit	2.00	2.00	2.00	2.50	2.50
	Bundle	26.00	24.00	24.00	30.00	30.00

UNITS PER	SqFt	2.54	2.18	2.18	1.75	1.75
	Layer	1	3	3	3	3
	Bundle	13.00	12.00	12.00	12.00	12.00

LBS PER	Units	56	64	66	94	93
	Layer	56	193	199	282	279
	Bundle	723	772	796	1,128	1,116

Colors	Reflectance	Stock	Stock	Stock	Stock	Stock
Buff	SR.n/a SRI n/a	✓	✓	✓	✓	✓
Grey	SR.n/a SRI n/a	✓	✓	✓	✓	✓

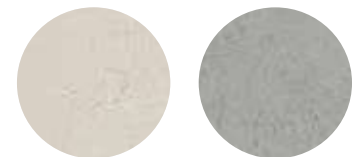

BUFF

GREY

SINGLE UNITS

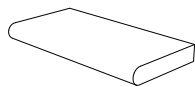

#### FULLNOSE COPING

610 x 305 x 60mm  
24 x 12 x 2 3/8"  
13 Units/Bundle  
.39 Fc.Ft./Stone

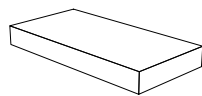

#### STANDARD COPING

610 x 305 x 70mm  
24 x 12 x 2 3/4"  
12 Units/Bundle  
.46 Fc.Ft./Stone

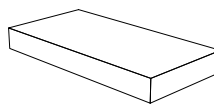

#### STANDARD CLOSED-END COPING

610 x 305 x 70mm  
24 x 12 x 2 3/4"  
12 Units/Bundle  
.46 Fc.Ft./Stone

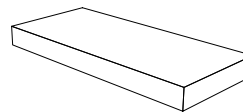

#### LARGE COPING

762 x 343 x 70mm  
30 x 13 1/2 x 2 3/4"  
12 Units/Bundle  
.57 Fc.Ft./Stone

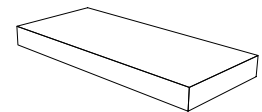

#### LARGE CLOSED-END COPING

762 x 343 x 70mm  
30 x 13 1/2 x 2 3/4"  
12 Units/Bundle  
.57 Fc.Ft./Stone

**Notes: SOLD IN FULL BUNDLES ONLY** and is produced and sold on a required, refundable skid. Coping is rock faced on the front and the back; Closed-end coping are rock faced on three sides. Fullnose is rounded only on one side, no Closed-end available. All measurements are nominal. Contact Unilock for more information.

# Ledgestone™ Pillar Caps, Steps & Fire Pit Coping



## APPLICATIONS

Pillar, Steps, Step Treads

## APPEARANCE

Surface Texture - Textured

## TECHNICAL INFORMATION

Conforms to ASTM C1776

Eligible for LEED v4.1 credits

	21½" FIRE PIT COPING	24" PILLAR CAP	28" PILLAR CAP	48" STEP	72" STEP
Bundle Type	SINGLE	SINGLE	SINGLE	SINGLE	SINGLE
Plant Produced	CHICAGO	CHICAGO	CHICAGO	MULTI-PLANT	MULTI-PLANT
Thickness (mm)	65 mm	100 mm	100 mm	150 mm	150 mm

FCFT PER	Bundle	-	-	-	5.91	8.86
	Layer	-	-	-	1.97	2.95
	Stone	-	-	-	1.97	2.95

PER BUNDLE	Layers	6.00	5.00	5.00	3.00	3.00
	Sections	-	-	-	-	-

LNFT PER	Bundle	-	-	-	12.00	18.00
	Unit	-	-	-	4.00	6.00

UNITS PER	SqFt	-	-	-	0.51	0.34
	Section	-	-	-	-	-
	Bundle	24.00	5.00	5.00	3.00	3.00

LBS PER	Layer	142	159	206	556	813
	Section	-	-	-	-	-
	Bundle	852	795	1,030	1,669	2,439

Colors	Reflectance	Stock	Stock	Stock	Stock	Stock
Buff	SR.n/a SRI n/a	✓	✓	✓	✓	SO
Grey	SR.n/a SRI n/a	✓	✓	✓	✓	SO

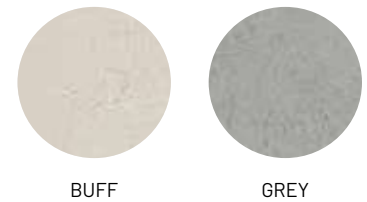

SINGLE UNIT

**ROCKFACE  
FIRE PIT COPING**  
254 x 546 x 65mm  
10 x 21½ x 2 5/8"  
24 Units/Bundle

8 pieces per Fire pit,  
Outside Diameter 54"  
Inside Diameter 34"

SINGLE UNITS  
PILLAR CAP

**24" ROCKFACE  
PILLAR CAP**  
610 x 610 x 100mm  
24 x 24 x 3 7/8"  
5 Units/Bundle  
.66 Fc.Ft./Stone

**28" ROCKFACE  
PILLAR CAP**  
740 x 740 x 100mm  
28 ½ x 28 ½ x 4"  
5 Units/Bundle  
.66 Fc.Ft./Stone

SINGLE UNITS  
STEPS

**48" ROCKFACE  
STEP**  
1220 x 610 x 150mm  
48 x 24 x 5 7/8"  
3 Units/Bundle  
1.97 Fc.Ft./Stone

**72" ROCKFACE  
STEP**  
1830 x 610 x 150mm  
72 x 24 x 5 7/8"  
3 Units/Bundle  
2.95 Fc.Ft./Stone

**Notes: Special Order (SO)** items may have minimum order quantities & extended lead time required. Produced and sold on a required, refundable skid. Step is rock-faced on 3 sides, while the Pillar Caps are rock-faced on all 4 sides. All measurements are nominal. Contact Unilock for more information.



## APPLICATIONS

Pillar, Water Feature, Pool Coping  
Fire Feature, Wall Coping, Steps

## APPEARANCE

Edge Detail - Chamfered, Rounded  
Surface Texture - Umbriano Mottled

## TECHNICAL INFORMATION

Conforms to ASTM C 936  
Eligible for LEED v4.1 credits

	CHAMFERED 24 x 14	FULLNOSE 24 x 14
Bundle Type	SINGLE	SINGLE
Plant Produced	ONTARIO	ONTARIO
Thickness (mm)	60 mm	60 mm

FCFT PER	Stone	-	-
	Layer	-	-
	Bundle	-	-

PER BUNDLE	Layers	6.00	6.00
------------	--------	------	------

LNFT PER	Unit	1.97	1.97
	Bundle	47.24	47.24

UNITS PER	SqFt	-	-
	Layer	4	4
	Bundle	24.00	24.00

LBS PER	Units	63	63
	Layer	252	252
	Bundle	1,510	1,510

Colors	Reflectance	Stock	Stock
French Grey	SR .18 SRI 17	SO	SO
Grenada White	SR .45 SRI 52	SO	SO
Midnight Sky	SR .17 SRI 15	SO	SO
Summer Wheat	SR .42 SRI 48	SO	SO
Winter Marvel	SR .35 SRI 38	SO	SO

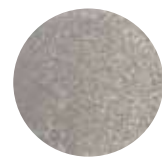

FRENCH GREY



GRENADA WHITE



MIDNIGHT SKY



SUMMER WHEAT



WINTER MARVEL

SINGLE UNITS

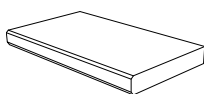

**CHAMFERED**  
600 x 360 x 60 mm  
24 x 14 x 2 3/8"  
24 Units/Bundle

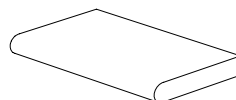

**FULLNOSE**  
600 x 360 x 60 mm  
24 x 14 x 2 3/8"  
24 Units/Bundle

Notes: Special Order (SO). Minimum quantities apply. Lead time required. SOLD IN FULL BUNDLES ONLY and is produced and sold on a required, refundable skid. Important: A urethane rubber paver mat must be used to prevent scuffing when compacting on textured surfaces. All measurements are nominal. Contact Unilock for more information.

# Sunset Fire Pit Kit



## APPLICATIONS

Fire Feature

## APPEARANCE

Surface Texture - Standard / Tumbled

## TECHNICAL INFORMATION

Conforms to ASTM C 1372

Eligible for LEED v4.1 credits

	ROUND
Bundle Type	SINGLE
Dimension Metric	1300 x 1300 x 300mm
Dimension Imperial	51 1/4 x 51 1/4 x 11 7/8"
Thickness (mm)	300 mm

DIAMETER (inch)	Outside	52.00
	Inside	36.00
	Insert	34.00

LAYER PER UNIT	3.00
UNIT PER LAYER	20.00
UNIT PER PALLET	60.00

LBS PER PALLET	1,125
----------------	-------

Colors	Reflectance	Stock
Charcoal	SR. n/a SRI n/a	✓
Coffee Creek	SR. n/a SRI n/a	✓
Limestone	SR. n/a SRI n/a	✓
Sandstone	SR. n/a SRI n/a	✓
Sierra	SR. n/a SRI n/a	✓

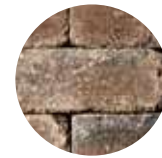

COFFEE CREEK



LIMESTONE



SANDSTONE



SIERRA

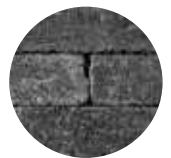

CHARCOAL

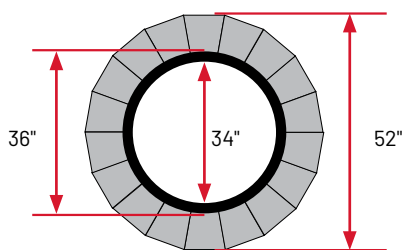

INSERT DIAMETER  
34"

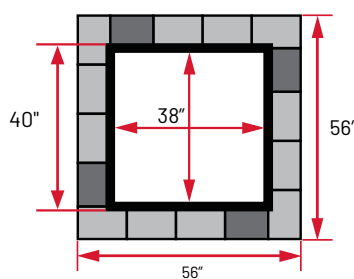

INSERT DIAMETER \*  
38"

SINGLE UNIT



**SUNSET ROUND**  
1300 x 1300 x 300mm  
51 1/4 x 51 1/4 x 11 7/8"

**FIRE PIT INSERTS SOLD SEPARATELY**

### FIRE PIT WARNING

Wood-burning fire pits must be lined with a proper metal insert or refractory (fire-rated) brick to protect the concrete components from extreme exposure to heat. Extreme heat on a concrete surface may affect the structural integrity of the concrete and can be dangerous. The floor of the fire pit should always be constructed using refractory brick or a sand bed. For your safety, always use a spark screen over the fire.

Notes: **SOLD IN FULL BUNDLES ONLY.** All measurements are nominal. Square fire pit can be created by purchasing a square insert and one pallet of corner wall product. Contact Unilock for more information.

# Unilock Elements

## TUSCANY COLLECTION



**TUSCANY FIREPLACE**  
Sandstone with Copthorne® (3 Color Blend)  
**SPECIAL ORDER**



**TUSCANY FIREPLACE**  
Sierra with Copthorne® (3 Color Blend)  
**SPECIAL ORDER**

**WEIGHT**  
Fireplace Top – 2,925 lbs  
Fireplace Bottom – 4,225 lbs  
Wood Boxes – 4,005 lbs  
Arched Hearth – 1,170 lbs

## BARCELONA COLLECTION



**BARCELONA FIREPLACE**  
Sierra with Umbriano® (Summer Wheat)  
**SPECIAL ORDER**

**WEIGHT**  
Fireplace Top – 2,725 lbs  
Fireplace Bottom – 4,170 lbs  
Wood Boxes – 4,200 lbs  
Arched Hearth – 1,200 lbs

## MODA

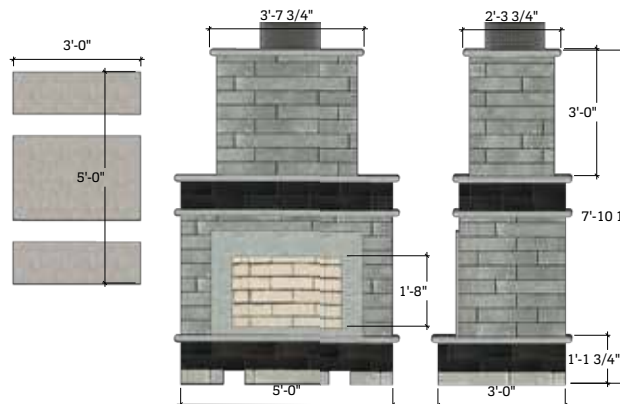

**MODA**  
**SPECIAL ORDER**

**WEIGHT**  
Moda Base – 3,550 lbs  
Moda Top – 1,915 lbs

The Moda pre-built fireplace is constructed from Lineo Dimensional Stone and Series™ accent.

Note: Please contact Unilock for more information on special order items. Units and measurements may not be exactly as shown.

# Unilock Elements

## TUSCANY & BARCELONA FIREPLACE

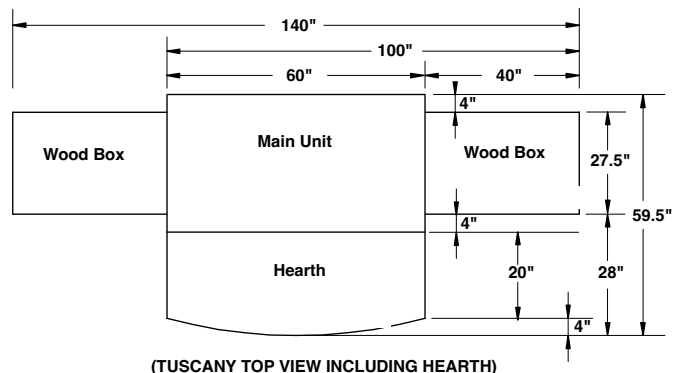
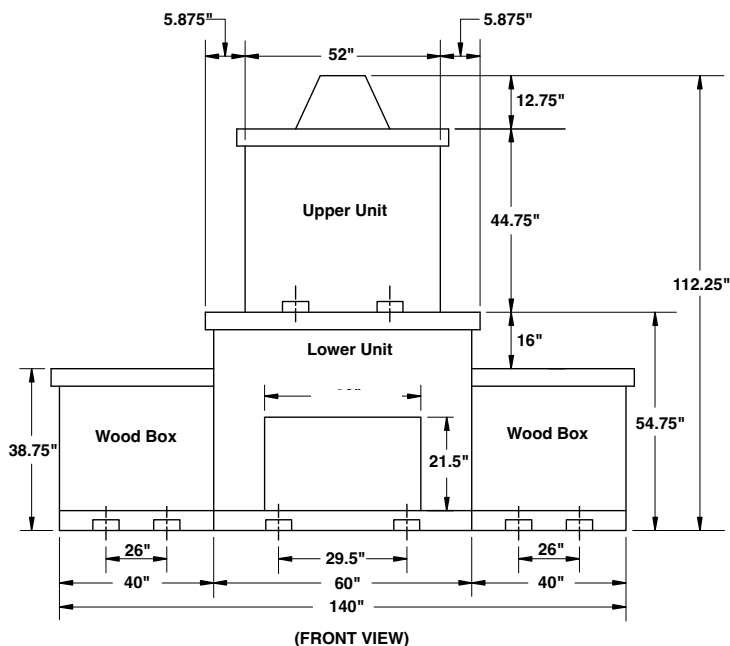

## TYPICAL CROSS SECTION FOR CONCRETE PAD INSTALLATION

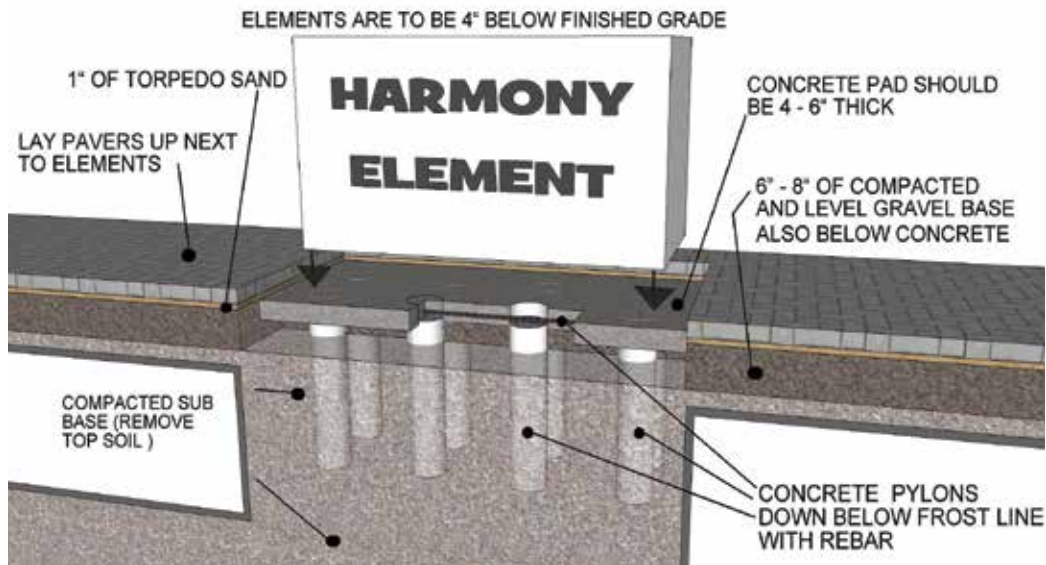

### GUARANTEE

The standard Unilock guarantee applies to the units used to construct Unilock Elements. (See Unilock literature for details.) Third party grills and fireboxes carry their respective manufacturer's warranty, and may change without notice.

**Note:** Unilock reserves the right to change model designs, accessories and colors without notice. Unilock will not be responsible for improper use or handling that results in property damage. Some models may not be exactly as shown. Fireplaces come complete with UL- approved stainless steel fireboxes. Check local building codes and regulations prior to ordering and installing Unilock Elements.

NEW from Unilock, the SkyView Roof Deck System is a comprehensive product lineup that includes adjustable pedestals, invisible wind uplift solutions, roof deck slabs, wood tile, and fiberglass grate. Together, these components offer unmatched flexibility, empowering designers to create elevated rooftop spaces that are visually stunning, durable and high-performing. The system's intuitive design also simplifies installation for contractors, ensuring efficiency without compromising quality. With SkyView, reimagine what's possible for roof deck design and construction.

## SKYVIEW PEDESTAL SYSTEM

Unilock SkyView Pedestals are patent pending, fully adjustable structural supports for elevating paving materials. Our pedestals ensure unmatched flexibility, ease of installation and durability.



- 1/2" and 1" Waffles available for low profile applications.
- 10" Cores and Collars available for taller applications up to 31".

## SKYVIEW GRATE

When this 48 x 48" fiberglass grate is placed on SkyView Pedestals, it creates a stable surface for installing smaller paver units on an elevated roof deck.

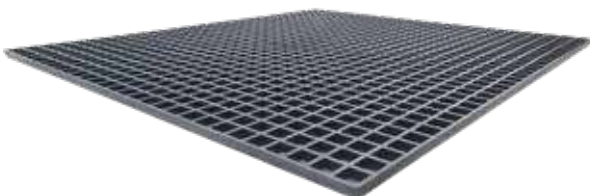

## SKYVIEW WIND UPLIFT SYSTEM

When the below components are combined with the SkyView Pedestal System, they create a rafted paving surface with an invisible tie-down mechanism that resists wind uplift pressures without compromising project aesthetics.

### 1 | Wind Uplift Slabs

24 x 24" slabs featuring a kerfed undercut that spans the length of two opposing sides.

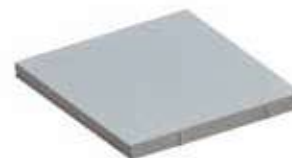

### 2 | Wind Uplift Kit

This 3-part kit is easily added to SkyView Pedestals to form a tie-down mechanism that works seamlessly with our Wind Uplift Slabs.



SCREW



KEYWAY  
LOCKDOWN BAR



PUCK

## SKYVIEW IPE WOOD TILE

Sustainably harvested and FSC certified, these 24 x 24" tiles have a dense hardwood composition that makes them perfect for use on SkyView Pedestals.



Ask your Unilock Representative about the made to order roof deck slab options available for your projects.

## Paver Cleaners



### ALLIANCE GATOR OIL & GREASE CLEANER

RS-CLN050 1Qt 6/case

- Effective in removing oil and grease from the surface of concrete pavers and natural stones
- Easy to use - dissolves, dislodges and removes oil and grease



### ALLIANCE GATOR EFFLORESCENCE CLEANER & SLURRY REMOVER

RS-CLN045 1Gal 4/case

- Removes any efflorescence stains trapped in the concrete paver and natural stone pores
- Makes the pavers look more clean and vibrant



### ALLIANCE GATOR RUST CLEANER

RS-CLN051 1Qt 6/case

- Effective in removing rust from the surface of concrete pavers
- Contains no muriatic acid

## Natural Stone Cleaners & Sealers



### UNICARE NATURAL STONE ACID CLEAN

RS-CLN095 1L 6/Case

Removal of:

- Efflorescence
- Cement mortar & Grout



### UNICARE NATURAL POWER CLEAN

RS-CLN096 1L 6/Case

Removal of:

- Oil & Grease, Food Stains
- General Dirt & Mud
- Sap & certain plant stains
- Light cement contamination (on acid sensitive surfaces)



### UNICARE BIOCLEAN

RS-CLN097 1L 6/Case

Removal of:

- Green & Black spot algae
- Organic staining from leaves, berries, food, coffee and wine stains



### UNICARE NATURAL STONE MATTE SEALER

RS-SEAL231 5L

For Porous Stones

- No change of color
- No surface coating, sheen or shine at all
- Riven Sandstone & Smooth Sandstone



### UNICARE NATCOLOR ENHANCE SEALER

RS-SEAL232 5L

- Color Enhancement and Breathable
- Lasts several years
- Easy to apply

## Sealers



### ALLIANCE GATOR WET LOOK SEALER

RS-SEAL143 1GAL 4/case

RS-SEAL144 5 GAL

- Film forming, Joint Stabilizer Sealer
- Protects against de-icing salt, motor oil & grease stains
- High-Gloss, solvent-based
- Coverage: 175 SqFt/gallon (875/sq ft. 5 gallons)



### ALLIANCE GATOR SATIN LOOK SEALER

RS-SEAL141 1GAL 4/case

RS-SEAL142 5 GAL

- Film forming, Joint Stabilizer Sealer
- Protects against de-icing salt, motor oil & grease stains
- High-Gloss, solvent-based
- Coverage: 175 Sq Ft/gallon (875/sq ft. 5 gallons)



### ALLIANCE GATOR HYBRID SEAL HIGH GLOSS

RS-SEAL145 1GAL 4/case

RS-SEAL146 5 GAL

- Film forming, Joint Stabilizer Sealer
- Protects against de-icing salt, motor oil & grease stains
- Low VOC, High-Gloss,
- Coverage: 100-225 SqFt/gallon (500-1125 sqft. /5 gallons)



### ALLIANCE GATOR LOW GLOSS

RS-SEAL147 1GAL 4/case

RS-SEAL148 5 GAL

- Film forming, Joint Stabilizer Sealer
- Protects against de-icing salt, motor oil & grease stains
- Low VOC, High-Gloss,
- Coverage: 100-225 SqFt/gallon (500-1125 sqft. /5 gallons)



### SUREBOND 1300 JOINT SAND STABILIZING SEALER - MATTE FINISH

RS-SEAL008 1GAL 4/case

RS-SEAL009 5 GAL

- Seals surface & hardens joint sand, while protecting the sealer film from mold, moss & algae
- Reduces sand washout, weeds & insect infestation
- Locks in a clean, natural look & matte finish.
- Product is breathable, designed for immediate application and is water-based; moisture or efflorescence will not get trapped
- Approximate Coverage: 80-120 sq.ft

Note: Carefully read all instructions and safety information on product label prior to application. For additional safety information, see MSDS.

## Sealers continued



### SUREBOND 7700 JOINT STABILIZING SEALER - GLOSS FINISH WITH ANTIFUNGAL PROTECTION

RS-SEAL135 1Gal 4/Case  
RS-SEAL136 5 Gal

- Breathable, Joint Stabilizer Sealer
- Anti-Fungal Film Protection, protects against mold, moss & algae
- Non-hazardous with the consistency of water; milky white in appearance when applied, dries crystal clear creating a semi-gloss finish.
- Coverage: Approx: 80-120 SqFt./Gallon creating a semi-gloss finish.



### SUREBOND 8700 WET LOOK JOINT SAND STABILIZER WITH FUNGICIDE

RS-SEAL151 1Gal 4/Case  
RS-SEAL152 5 Gal

- A 2 in 1 product; protects the substrate surface and stabilizes jointing sand at the same time.
- Formulated with antifungal agents designed to help stop the growth of mold, moss and algae.
- Wet look, rain safe in 90 minutes, water-repellent breathable, solvent-based.
- Coverage: Approx: 80 -120 SqFt SqFt./Gallon

## Sands



### POLYBIND™ HP SAND

RS-SAND078 Tan | RS-SAND080 Grey  
50lb/bag \* 56 bags/skid

- Designed for paver joints up to a maximum of 1 inch.
- Helps prevent weeds and damage caused by insects
- Coverage: 65-85 sq.ft./ bag for joints 1/8" to 3/8"
- 22-42 Sqft./bag for larger joints 3/4" to 1"



### POLYBIND™ COMPLETE SAND

RS-SAND074 Tan | RS-SAND075 Grey  
50lb/bag \* 56 bags/skid

- Advanced haze-free polymeric sand.
- Formulated for pavers, slabs & wet cast pavers up to 1".
- Rain safe 1 hour after water activation.
- Coverage: 65-85 Sq.Ft./bag with joints 1/8" to 3/8".



### POLYBIND G2 SAND

RS-SAND150 Tan | RS-SAND151 Grey  
50lb/bag \* 56 bags/skid

- No blower needed and the intelligent polymeric sand requires only one watering. application is now dust free and haze free.
- Sets above the freezing temperature 32°F and can be used for joints up to a maximum of 2 in.
- Coverage: 65-85 sq.ft./ bag for joints 1/8" to 3/8" 22-42 Sqft./bag for larger joints 3/4" to 1 1/4"

## Sands continued



### POLYBIND G2 COMPLETE SAND

RS-SAND152 Tan | RS-SAND153 Grey  
RS-SAND154 Black | RS-SAND155 Ivory  
50lb/bag \* 56 bags/skid

- Designed for paver joints up to maximum of 4".
- Drainage & non-drainage overlay applications.
- Can be used with concrete pavers & natural stones, and is recommended for use in patios, pool decks, walkways, driveways, etc.
- Coverage: 65-85 sq.ft./ bag for joints 1/8" to 3/8" 22-42 Sqft./bag for larger joints 3/4" to 1 1/4"



### POLYBIND DUST

RS-SAND072 Tan | RS-SAND073 Grey  
50lb/bag \* 56 bags/skid

- Colors: Tan & Grey
- Designed for natural stone joints 1/2" to 4".
- Once set, becomes very firm and locks between the stone joints, maintaining a bond that holds the stones securely in place.
- Coverage: 20-30 sq.ft. per bag for joints 1"-2" wide and stones approximately 2" thick



### ALLIANCE GATOR NITRO SAND

RS-SAND196 Beige | RS-SAND197 Grey  
RS-SAND198 Black | RS-SAND236 Silver  
40 lb bucket • 48 buckets/skid

- Ready to use permeable jointing material.
- Can be installed in wet or dry weather.
- Formulated for joints from 1/2" to 2".
- Ideal for concrete & wetcast pavers, Natural Stone & Porcelain Tile.
- Coverage: 10-84 Sq.Ft./bucket depending on joint



### GATOR NITRO-X FINE JOINT **NEW**

RS-SAND244 Black | RS-SAND245 Gunmetal  
RS-SAND248 Taupe | RS-SAND247 Platinum  
RS-SAND246 Vanilla  
275 lbs Pail • 48 Pails/Pallet

- Rapid Flow Technology
- Fast and simple installation
- Xtra Fine gradation jointing sand
- Xtra Low permeability
- Xtra Strength from top to bottom \*\*\*
- Apply rain or shine
- Joint width from 1/8" to 2" (3 mm to 50 mm)\*\*\*\*
- 5-year limited warrantywidth.

\*\*\* Gator Nitro-X Fine Joint Sand will harden from top to bottom up to 2 3/8" (60 mm).

\*\*\*\* Ensure there is ABSOLUTELY NO paver, porcelain tile or stone movement prior to installation to prevent joint cracking.

RAPID FLOW TECHNOLOGY



### ALLIANCE EUROSTONE BOND

RS-SAND095 Beige | RS-SAND097- Grey  
50lb/bag \* 56 bags/skid

- The first polymeric sand specifically designed for drainage and non-drainage base systems.
- Can be used with natural stones and cobblestone.
- Sets above the freezing temperature (0°C / 32°F) and can be used for joints up to a maximum of 35mm/ 1".

## Sands continued



### SEK POLYSWEEP POLYMERIC SAND

RS-SAND046 Tan | RS-SAND046 Grey  
RS-SAND147 - Platinum | RS-SAND200 - Fieldstone  
50lb/bag \* 56 bags/skid

- Recommended for joints up to 3/4".
- Haze Free Guaranteed - Advanced Clear Set Technology.
- Coverage 50-75 Sq.Ft./bag with standard 1/4" joints.



### SEK POLYSWEEP SAND X-TREME WIDE JOINT

RS-SAND111 - Tan | RS-SAND117 - Grey;  
RS-SAND185 - Black | RS-SAND149 - Platinum  
50 lb/bag • 56 bags/skid (2860 lbs/skid)

- Formulated for joints 1/8" up to 4".
- Haze Free Guaranteed - Advanced Clear Set Technology.
- Coverage 50-75 Sq.Ft./bag with standard 1/4" joints.



### SUREBOND JOINTING SAND

RS-SAND187 - Tan | RS-SAND188 - Grey;  
RS-SAND201 - Fieldstone | RS-SAND149 - Platinum  
50 lb/bag • 56 bags/skid (2860 lbs/skid)

- Formulated for joints 1/8" up to 4".
- Haze Free Guaranteed - Advanced Clear Set Technology.
- Coverage 50-75 Sq.Ft./bag with standard 1/4" joints.

## X & T Slab Spacers

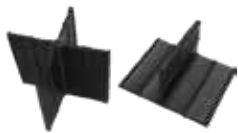

### X & T SLAB SPACERS

RS-ACC237 - X Spacers; 2" x 2"; 250 pcs./bag  
RS-ACC236 - T Spacers; 2" x 1"; 250pcs./bag

- Unilock recommends using slab spacers when installing Arcana on an open grade surface
- "T" spacers are needed for running bond patterns; "X" spacers for stack bond patterns. Please contact your sales manager for more information
- X & T bagged separately

## Edging Products

### SEK SNAPEDGE

RS-EDGE001 - 8' (96") piece; 24 pcs./bundle; 28 bundles (672 pcs)/skid

- One-piece edging system that handles both straight & curved installations.
- Unique and quick snip 'n flex feature.
- Open base design allows root and grass system to grow through.
- Standard Sidewall: 1 7/8" | Low Profile Sidewall: 1 3/8"
- Skid Dimensions: 98"L x 48"W x 50"H - 210 lbs./skid



### PERMEDGE PERMEABLE PAVER EDGING

RS-EDGE033

- Designed specifically for permeable pavement with open-graded base material.
- Holds pavement edges securely in place.
- Does straight and curved edges.

#### Product Information:

8' (96") length pcs.  
Weight per Unit: 2.5 lbs.  
Pieces per Pallet: 64 (72 in. ft.)  
Freight Class: 300  
Pallet Weight: 210 lbs.  
Pallet Size: 98" l x 48" w x 50" h



### ALLIANCE GATOR NAIL 10" SPIRAL

RS-EDGE048 50 LB/Box (48 cases/skid)

- Use with compacted aggregate only
- Use one nail every second hole of gator edge
- Approx. 250-260 Nails per Box

### PERMAPACK

- Extreme flexural strength
- Water stop technology
- Shrink control
- Void Reduction
- Macro Synthetic Fibers
- Coverage:

**Open graded base:** 1 Perma Pak/50-60# bag of concrete will produce 12'-16' open graded/clear base (chip bedding)

**Dense Base:** 1 Perma Pak/50-60# bag of concrete will produce 17'-21' dense/crushed base (sand bedding)

- Packaging:
- 1 Perma Pak (1 lb. per packet)
- 1 Box of Perma Paks (30 packets per box - 31 lbs.)
- 1 Skid (32 boxes/960 packets - 1030 lbs.)



### ALLIANCE GATOR XTREME EDGE

RS-EDGE076

- The ultimate fiber-reinforced structural edging solution for any hardscape project.
- Can be used for any traditional, open-graded, permeable, Gator Base or overlay application using concrete pavers or slabs, natural and wet cast stones.
- Offers permanent continuous lateral support.
- Packaging: 50 lb bag / 56 bags per skid.
- Coverage: 20-25 sqft coverage per bag for a 60mm paver.

# Adhesives



## SUREBOND SB-15 ADHESIVE

RS-ADH050 10oz tube; 12/case; 140cases/skid  
RS-ADH051 28oz tube; 12/case; 60 Cases/skid

- Rapid set, 70% faster set time.
- Superior durability including heavy vehicular traffic.
- Temperatures ranging from 10 - 100°F.
- 1200 psi.



## ALLIANCE XP GATOR BLOCK ADHESIVE

RS-ADH035 10 oz; 12/case; 90 cases/skid (1080 ea).  
RS-ADH038 28 oz; 12/case; 60 cases/skid (720 ea).

- Bonds permanently in 24 hours.
- Material may be repositioned for up to 30 minutes.
- Works in temperatures above 32°F.
- 850 psi in 24 hrs (1000 psi in 7 days).



## TECHNISEAL STRUCTURE BOND™ FOAM ADHESIVE

RS-ADH048 24 oz ; 12/case; 84 cases/skid (1008 ea).

- Superstrength foam adhesive
- Most items are bonded in just 8 minutes.
- Works best in temperatures between 0- 120°F.
- Yields up to 600 In.ft. with a 3/8" bead.



## TECHNISEAL STRUCTURE BOND™ GUN II

RS-TOOL378 ~ 1 Dispenser (12/case)

- Perfect for hard-to-reach applications.
- Limits excessive spillage or dripping.
- Reusable: Easy clean-up using Gun Cleaner.



## TECHNISEAL STICKY STONE

RS-ADH055 20.3 oz sausage; 15 sausages/case;  
66 cases/skid

- Heavy-duty dispenser gun specially designed for Stickystone.
- Each gun kit includes: 6 nozzles, 2 extra pistons & steel hook pull..



## STICKY STONE GUN

RS-TOOL557 1 dispenser gun kit; 10 kits/case

- Heavy-duty dispenser gun specially designed for Stickystone.
- Each gun kit includes: 6 nozzles, 2 extra pistons & steel hook pull.



## TECHNISEAL STRUCTURE BOND™ CLEANER

RS-CLN093 (16 oz) / Canister; 12canister/case

Rapidly dissolves any uncured Structure Bond adhesive residue.

# Geotextiles and Fabric Products



## UNILOCK DRIVEGRID™ SYSTEM

RS-FAB104

120' x 12.5' Roll,  
1,500 Sq.Ft./Roll  
56 lbs/Roll



## GATOR GRID 30-30

RS-FAB070 4' x 50' / 16 rolls per box  
RS-FAB071 6' x 50' / 20 rolls per pallet

Gator Grid 30-30, a biaxial geogrid, provides strength, longevity, excellent stress transfer and prevents failure to the internal structure of landing areas, retaining walls and steep slopes. It has a high molecular weight as well as high-tenacity polyester yards which are woven in tension and finished with a PVC coating.



## GATOR FABRIC NON-WOVEN 3.5

RS-FAB038 4' x 100' / 4 roll package  
RS-FAB040 6' x 100' / 12 roll package

Gator Fabric Non-Woven 3.5 geotextile is ideal for drainage, filtration and will allow water flow in a paver or retaining wall application. It is designed for soil separation for added stability, has high strength and is dimensionally stable.



## GATOR FABRIC WOVEN 5

RS-FAB049 4' x 100' / 4 roll package  
RS-FAB052 6.25' x 300' / 12 roll package

Gator Fabric Woven 5 is a woven geotextile made from polypropylene yarns and can achieve higher tensile strength at low elongation. It is an excellent heavy-loading geotextile, ideal for driveways, alleyways, pathways and retaining walls.



## GATOR FABRIC POLYSPUN 20 SPECIAL ORDER

S.O 3' x 50' / 16 rolls per case / 64 rolls per skid  
RS-FAB055 3' x 100' / 9 rolls per case / 36 rolls per skid  
S.O 4' x 100' / 9 rolls per case / 36 rolls per skid  
RS-FAB0558 6' x 100' / 30 rolls per case / 36 rolls per skid  
Gator Fabric Polyspun 20 geotextile is specially formulated to resist deterioration in garden and landscape applications. It creates a barrier to reduce weed growth and allows water, fertilizer and aire to pass through.

## Tools & Accessories



Install up to 700 sq. ft. per hour!

- Access tight or narrow areas.
- Eliminate the need for a forklift on site.
- Reduce labor costs.
- Reduce shoulder, hand & knee pain and injury.
- Improve your bottom line.

Contact your local rep for details



**Model  
MINI P**



### PISA XL LIFTING TONG

- The Pisa XL tong makes it easier to lift and place units, especially on the base course.
- The action of lifting the handle secures the lifter and makes for easy, balanced lifting and placement.



### U-LEVEL™

- Easy to use.
- Accurate readings.
- Low maintenance.
- Works in difficult locations.
- Large working area.

A PRECISION TOOL NO HARDSCAPER SHOULD BE WITHOUT

## Base/Drainage Systems

### GATOR TILE SYSTEM

Contact Unilock for more information.



RS-ACC074-1



RS-ACC087



RS-EDGE061



RS-ACC088

# Turf products



Alliance xTurf Products	Premium Blend		Classic Blend		Putting Green
Colors	Forest Green	Lime Green (SO)	Forest Green	Lime Green (SO)	Summer Green
Roll Sizes	7.5x25' (RS-TURF003)	7.5x25' (RS-TURF007)	7.5x25' (RS-TURF011)	7.5x25' (RS-TURF015)	7.5x25' (RS-TURF018)
	7.5x50' (RS-TURF004)	7.5x50' (RS-TURF008)	7.5x50' (RS-TURF012)	7.5x50' (RS-TURF016)	15x25' (RS-TURF017)
	15x33' (RS-TURF002)	15x33' (RS-TURF006)	15x33' (RS-TURF010)	15x33' (RS-TURF014)	
	15x100' (RS-TURF001)	15x100' (RS-TURF005)	15x100' (RS-TURF009)	15x100' (RS-TURF013)	
Pile Height	1.75" (45mm)		1.58" (40mm)		.63" (16mm)
Face Weight oz./Sq. Yd.	85 oz.		47 oz.		50 oz.

RS-TURF019	Gator X-Turf Infill Beige 50lb
RS-TURF020	Gator X-Turf Infill Green 50lb
RS-TURF021	Gator X-Turf Infill Zeo-White 40lb

RS-TURF022	Gator X-Turf Nails Spiral 6"
RS-TURF023	Gator X-Turf Seam Tape Roll 12x100
RS-TURF024	Gator X-Turf Seam Tape Roll 12x300
RS-TURF025	Gator X-Turf XP Odor Remover 27oz 12/case



- No Mowing, No Watering
- High Quality artificial Turf
- 20 limited year warranty

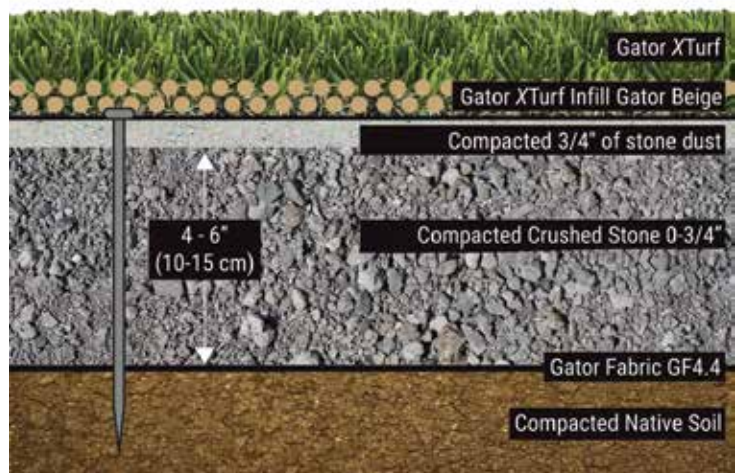

# Accessory Quick Reference Guide

## ADHESIVES

Paverbond Adhesive	RS-ADH001 - 10.5 oz. RS-ADH011 - 28 oz
Polybind High Strength Adhesive	RS-ADH032 - 10 oz. RS-ADH033 - 28 oz.
Alliance Gator Block Bond XP Adhesive	RS-ADH035 - 10 oz. RS-ADH038 - 28 oz.
SEK SB-15 Rapid Set Adhesive	RS-ADH050 - 10 oz. RS-ADH051 - 28 oz.
RS-ADH048	TS STRUCTUREBOND 24 OZ
RS-ADH055	TS Sticky Stone 20oz Sausage

## CLEANERS

SureStrip 1 gal	RS-CLN031
Gator Efflo Cleaner 1 gal	RS-CLN045
Gator Shampoo 1 gal	RS-CLN047
Gator XP Oil and Grease Remover 1QT	RS-CLN050
Gator Rust Remover 1 QT	RS-CLN051
SEK Efflo Off 1 gal	RS-CLN062
UniCare NS AcidClean 1L	RS-CLN095
UniCare NS PowerClean 1L	RS-CLN096
UniCare NS BioClean 1L	RS-CLN097

## EDGING

Perma Edge-Perma Pak - 1 lb	RS-EDGE087-1
Gator Xtreme Edge Bag 50#	RS-EDGE076
SEK Perm Edge	RS-EDGE033
SEK Snap Edge	RS-EDGE001
Gator Nail Spiral 10" Spikes	RS-EDGE048

## GEOTEXTILES & FABRIC

Alliance Gator Grid 30-30	RS-FAB070 - 4X50' RS-FAB071 - 6X50'
Alliance Non-Woven 3.5 Fabric	RS-FAB037 - 3X100' RS-FAB040 - 6X100'
Alliance Woven 5 Fabric	RS-FAB049 - 4X100' RS-FAB052 - 6.25X300'
Unilock Drivegrid System	RS-FAB104
Strata Grid SGU60 6.25x288	RS-FAB101
Alliance Polyspun 20 Fabric (SO)	RS-FAB054 - 3X50' RS-FAB055 - 3X100' RS-FAB057 - 4X100' RS-FAB058 - 6X100'

## SEALERS

Surebond SB1300 Joint Stabilizing Sealer	RS-SEAL008 - 1 GAL RS-SEAL009 - 5 GAL RS-SEAL011 - 55 GAL
Surebond SB7700 Antifungal Sealer	RS-SEAL135 - 1 GAL RS-SEAL136 - 5 GAL RS-SEAL241 - 55 GAL
Surebond SB8700 Joint Stabilizing Wetlook Sealer	RS-SEAL151 - 1 GAL RS-SEAL152 - 5 GAL RS-SEAL176 - 55 GAL
Alliance Gator Satin Look Solvent Based	RS-SEAL141 - 1 GAL RS-SEAL142 - 5 GAL
Alliance Gator Wet Look Solvent Based	RS-SEAL143 - 1 GAL RS-SEAL144 - 5 GAL
Alliance Gator Hybrid Water Based High Gloss	RS-SEAL145 - 1 GAL RS-SEAL146 - 5 GAL
Alliance Gator Hybrid Water Based LowGloss	RS-SEAL147 - 1 GAL RS-SEAL148 - 5 GAL
Unicare NS NatMatte Sealer 5L	RS-SEAL231
UniCare NS NatColorEnhance Sealer 5L	RS-SEAL232
Azpects Back to Black Limestone Sealer 1 qt	RS-SEAL238

## SKYVIEW PEDESTALS

SkyView Pedestal Std Kit 18/case	RS-SKYVW0001
SkyView Wind Uplift Kit 100/case	RS-SKYVW0002
SkyView Core 5" 36/case	RS-SKYVW0003
SkyView Core 10" 18/case	RS-SKYVW0004
SkyView Top Pad 160/case	RS-SKYVW0005
SkyView Collar 48/case	RS-SKYVW0006
SkyView Waffle 1" 48/case	RS-SKYVW0007
SkyView WindUplift Waffle 1" 48/case	RS-SKYVW0008
SkyView Waffle 1/2" 80/case	RS-SKYVW0009
SkyView WindUplift Waffle 1/2" 80/case	RS-SKYVW0010
SkyView Grate 48"x48" 16sf/pc	RS-SKYVW0011
SkyView Washers 60/case	RS-SKYVW0012
SkyView Ipe 24x24 Wood Tile 4sf/pc	RS-SKYVW0013

**SANDS**

Alliance Polybind Dust - 50lbs. Bags	RS-SAND072 - TAN RS-SAND073 - GREY
Alliance Polybind HP Sand - 50lbs. Bags	RS-SAND078 - TAN RS-SAND078 - GREY
Alliance EuroStone Bond - 50lbs. Bags	RS-SAND095 - BEIGE RS-SAND097 - OXFORD GREY
Alliance Polybind G2 Sand - 50 lbs. Bags	RS-SAND150 - TAN RS-SAND151 - GREY
Alliance Polybind G2 Complete - 50lbs. Bags	RS-SAND152 - TAN RS-SAND153 - GREY RS-SAND154 - BLACK RS-SAND155 - IVORY
Alliance Polybind Complete - 50lbs. Bags	RS-SAND074 - TAN RS-SAND075 - GREY
Sek Polysweep Polymeric Sand - 50 Lbs. Bags	RS-SAND045 - TAN RS-SAND046 - GREY RS-SAND147 - PLATINUM RS-SAND200 - FIELDSTONE
Sek Polysweep X-Treme Wide Joint Polymeric Sand - 50 Lbs. Bags	RS-SAND187 - TAN RS-SAND188 - GREY RS-SAND149 - PLATINUM RS-SAND201 - FIELDSTONE
Sek Jointing Sand - 50 Lbs. Bags	RS-SAND001-1 - TAN RS-SAND121 - GREY RS-SAND148 - PLATINUM RS-SAND230 - FIELDSTONE
Techniseal Next Gel Polysand - 50 Lbs. Bags	RS-SAND241 - TAN RS-SAND133 - URBAN GREY RS-SAND183 - GRANITE RS-SAND203 - BLACK
Techniseal Noco Polysand - 50 Lbs. Bags	RS-SAND189 - DESERT TAN RS-SAND190 - IRON GREY
Techniseal Next Gel Polysand - 50 Lbs. Bags	RS-SAND241 - TAN RS-SAND133 - URBAN GREY RS-SAND183 - GRANITE RS-SAND203 - BLACK
Azpects Easy Joint Sand 28lb	RS-SAND192 - MUSHROOM RS-SAND193 - GREY RS-SAND193 - GREY RS-SAND194 - BASALT RS-SAND195 - JET BLACK
Gator Nitro Sand - 40 Lbs. Buckets	RS-SAND196 - BEIGE RS-SAND197 - GREY RS-SAND198 - BLACK RS-SAND236 - SILVER
Gator Nitro X Sand - 27.5 Lbs. Buckets	RS-SAND244 - BLACK RS-SAND245 - GUNMETAL RS-SAND246 - VANILLA RS-SAND247 - PLATINUM RS-SAND248 - TAUPE
SEK PS-1500 RJS	RS-SAND233 - PEBBLE RS-SAND234 - SLATE RS-SAND235 - DRIFTWOOD
TS Storm - 40lbs. Bucket	RS-SAND238 - TAN RS-SAND239 - GRANITE RS-SAND240 - BLACK
Gator Aqua Rock Granite Grey 50 lb	RS-SAND112
Gator Aqua Rock Granite Grey Super Sack	RS-SAND129

**TOOLS**

Chisel W/Hand Guard	RS-TOOL052
Heavy Duty Block Tong	RS-TOOL371
TS Structurebond Gun II	RS-TOOL378
U-Level	RS-TOOL460
Weber VPR700 2 Plate Roller Compactor	RS-TOOL468
Weber VPR450 Roller Compactor	RS-TOOL494
IQMS362 Masonry Saw System 16.5"	RS-TOOL495
TS Sticky Stone Gun	RS-TOOL557

**TURF**

Alliance Gator X-Turf Premium Blend Forest Green	RS-TURF001 - 15x100' RS-TURF002 - 15x33' RS-TURF003 - 7.5x25' RS-TURF004 - 7.5x50'
Alliance Gator X-Turf Premium Blend Lime Green (SO)	RS-TURF005 - 15x100' RS-TURF006 - 15x33' RS-TURF007 - 7.5x25' RS-TURF008 - 7.5x50'
Alliance Gator X-Turf Classic Blend Forest Green	RS-TURF009 - 15x100' RS-TURF010 - 15x33' RS-TURF011 - 7.5x25' RS-TURF012 - 7.5x50'
Alliance Gator X-Turf Classic Blend Lime Green (SO)	RS-TURF013 - 15x100' RS-TURF014 - 15x33' RS-TURF015 - 7.5x25' RS-TURF016 - 7.5x50'
Alliance Gator X-Turf Putting Green	RS-TURF017 - 15x25' RS-TURF018 - 7.5x25'
Alliance Gator X-Turf Infill Sand Gator 50lbs. Bag (LSA)	RS-TURF019 - Beige RS-TURF020 - Green RS-TURF021 - Zeo-White (40lbs. Bag)
Alliance Gator X-Turf Seam Tape Roll (LSA)	RS-TURF023 - 12x100' RS-TURF024 - 12x300'
Gator X-Turf Nails Spiral 6"	RS-TURF022
Gator X-Turf XP Odor Remover 27oz 12/case (SO)	RS-TURF025

**UNILYFT**

Unilyft Tool Mini P Machine Gas Powered 842400H	RS-TOOL511
Unilyft All-Terrain Pallet Mover 843200	RS-TOOL575
Unilyft Model P Skid Steer 841300H	RS-TOOL576
Unilyft Model E Plug-In Electric Model 841000-140	RS-TOOL614
Unilyft L Narrow Track	RS-TOOL394
Unilyft PM Wide Track 841400P	RS-TOOL395

# Polysand Best Practices

- Ensure that paver surface has **proper drainage runoff** (Min 1" over 8'). Finished paver height should always be higher than grade to allow proper surface drainage.
- **Do not set pavers in limestone screenings.** This product holds moisture and does not meet the gradation, drainage qualities or strength of coarse concrete sand.
- Make sure pavers are **clean of all construction dust.** Residual construction dust will haze pavers!
- **Compact pavers** into setting bed to create proper interlock.
- Read and review all polysand manufacturers methods of application. **(Read Directions)**
- **Don't rush polysand installation.**
- Paver area must be completely dry.
- Lay bags of polysand over paver area. **Stage bags** in areas of coverage. Example: one bag for 60 square feet.
- **Do not over sweep sand.** Sweep sand back and forth within coverage area to fill paver joints.
- Compact sand into joints. This is a must in achieving proper density of the sand joint (repeat 3 times). Compaction is critical to assuring sand strength.
- Do not fill sand above the chamfer of paver. Sand should sit 1/8" below bottom of chamfer.
- Use a fine-bristle broom to **remove any excess sand from the paver surface.**
- Use a **leaf blower** remove any sand or binder residue.
- **Review all watering directions (each manufacturer has different watering instructions.) This is VERY IMPORTANT!**
- Always start watering at the **bottom of the slope.**
- Always start watering in **controlled areas** per manufacturers recommendations. Example: complete watering in 200 sq. ft. area then move on to the next 200 sq. ft. and repeat.
- During final watering of poly sand, **clean surface by removing excess water** with leaf blower or squeegee depending on paver surface texture. This will remove any leftover binder residue or sand.
- Final thoughts – Always be aware of the weather when installing poly sand. **(Temperature and setting time ratings differ between products.)**
- Refer to all manufacturers websites for installation videos.

SAND RECOMMENDATIONS BY PRODUCT	Polybind HP G2	Polybind Complete Sand G2	Polysweep Polymeric Sand	Unicare® Easy Pro®	Eurostone Eurostone Bond
PAVERS	For joints up to 1/8" May be sealed. Tan color Non-binding sand	For joints up to 1" May be sealed. Available in Tan or Grey Binding sand	For joints up to 4" May be sealed. Available in Tan or Grey Binding sand	For joints up to 1" May be sealed. Available in Tan or Black Binding sand	May be sealed. Available in Slate Grey
Copthorne®	✓	✓	✓*	✓	N/R
Courtstone®	N/R	N/R	N/R	N/R	✓
Il Campo®	N/R	N/R	N/R	N/R	N/R
Richcliff®	✓	✓	✓*	✓	N/R
Series™	N/R	N/R	N/R	N/R	N/R
Town Hall®	✓	✓	✓	✓	N/R
Umbriano®	✓	✓	N/R	N/R	N/R
Tumbled Pavers	✓	✓	✓	N/R	N/R
Standard Pavers	✓	✓	✓	✓	N/R

N/R - Not Recommended | ✓ Recommended | ✓\* These pavers have a very narrow or slightly angled edge (chamfer), limiting sand penetration in the joint and causing possible weak bonding areas. The life cycle performance could be affected.

---

# Sealer Best Practices

---

- The paver surface should be **clean** and free from oil, dirt, dust and any loose material. This ensures a uniform result and allows the sealer to better penetrate the surface.
- The pavers should be **free of any visible efflorescence**.
- If pavers have been sealed before, make sure to resealed with compatible product.
- **Surface must be dry** (48 hours without precipitation) and warm to the touch (morning).
- Joint sand must also be dry.
- Make sure lawn sprinklers are shut off.
- Best air temperature is between **50 degrees to 80 degrees** with no rain forecasted for the next 24 hours.
- It is best to apply product under constant weather conditions and use the **same application method from start to finish**.
- The paver joints should be completely filled with dry correctly-graded joint sand. The top level should not exceed the bottom of the chamfer or **1/8" below** the surface on the non-beveled or tumbled paver surface.
- **Always test the product** on a small hidden area to ensure the results will meet your expectations.
- Always show homeowners samples to ensure expectations.

**At this point read all sealer instructions and determine the best sealer for your desired goal. Do you want to retain the original look, enhance the color, or stabilize the sand joint?**

- **Read application information as each sealer can be applied differently.**
- **Make sure you have the correct equipment based on type of sealer. Solvent based sealers need solvent resistant sprayers, watering cans or paint trays.** Water base sealers can be generally applied using plastic equipment. Example: solvent based sealers come in metal containers and water based sealers come in plastic containers.
- Care should be taken that no excess sealer material is pooled on the surface during application always back roll. When using solvent based sealers make sure roller is solvent resistant or for all paints. Foam rollers work best and are less likely to pull sand from the joints.
- Stabilizing sealers are generally sprayed or flood coated with a watering can, then back rolled.
- Acrylic non-stabilizing sealers can be sprayed, then back rolled or rolled on using a metal paint tray.
- **Send your most experienced worker to do sealing projects.**

## IMPORTANT NOTICE

**1. DO NOT USE** Polymeric Jointing Sand on the following products:      Series™      Il Campo®

If joint stabilization is required, use ordinary jointing sand and apply a stabilizing sealer. Contact your local Unilock office for recommended sealants and application specifics.

**2. EXTRA CARE** must be exercised when using Polymeric Sand on the following products:

Courtstone®      Copthorne®      Richcliff®      Town Hall®      Umbriano®

Polymeric Jointing Sand can be used on these products but the fine polymers and binders in Polymeric Jointing Sand have a natural tendency to adhere to the surface and therefore extra diligence must be taken to pre-clean the surface prior to "wetting the sand in" and squeegee off the surface post application. Failure to do so will result in a "whitish haze" on the surface that is difficult to remove.

**3. IMPORTANT COMPACTION NOTICE:** Always pre-compact the pavers WITHOUT SAND IN THE JOINTS. This will facilitate proper leveling. Polymeric sand can then be swept into the joints. Always use a compactor with a protective membrane attached to the bottom of the plate.

**Polymeric Jointing Sand, cleaners and sealers, must always be applied by a trained and experienced professional. Contact your local Unilock office for training and the most up-to-date best practices.**

**NOTICE:** Unilock does not accept any responsibility for damage to the surface caused by the improper application and use of polymeric sand, sealers or cleaners. Unilock will not accept responsibility for alternate suppliers of polymeric sand, jointing sand, cleaners and sealers.

## NATURAL STONE INSTALLATION GUIDELINES

A slurry coat, sometimes called a bond or milk sealer coat, is brushed on to the back of each natural stone unit prior to installation in order to limit moisture penetration, prevent staining and aid adhesion.

## OPTIMAL COLOR BLENDING INSTALLATION

Blending colors from multiple (3+) bundles is ideal for the optimal color installation. DO NOT LAY PALLET TO PALLET!

---

# Important notes

---

## UNILOCK PAVER PATTERNS

This Product Data Guide contains an extensive reference to patterns and designs. The purpose of these pattern swatches is to help the designer plan unique and exceptional designs. The percentages of products shown are based on the pattern and not on bundle configurations. In fact, there may be situations in which a pattern has been created with one particular size of stone, but that stone only comes packaged with two other sizes. This means that the designer will have to plan how the other components are used in the overall plan. This is usually accomplished by adding a border or an accent. As a result, overages or shortages may occur in certain patterns. The designer and/or installer of Unilock products accepts all responsibility for design and all associated costs incurred as a result of applying any of Unilock's suggested design patterns in a project. Please plan your project and review your order carefully prior to ordering.

## TRANSFERABLE LIFETIME GUARANTEE

Unilock provides a Transferable Lifetime Guarantee\* on the structural integrity of Unilock concrete paving stones and retaining wall units when used in residential applications. Any materials installed and maintained to our guidelines, and subject to normal wear, that prove defective, will be replaced without cost. Color matching cannot be guaranteed and replacement labor is not included. Proof of purchase is required.



Scan for full Guarantee details

\*Transferable Lifetime Guarantee: Register your project within 60 days of your dated proof of purchase to ensure your Unilock Guarantee is fully transferable! Simply go online at [unilock.com](http://unilock.com) and follow instructions. Once processed, you will receive an original Transferable Warranty Certificate for your records.

## PRODUCT HANDLING WARNING

**Bundle Straps Under Tension - Use extreme caution when removing or handling straps.** Always wear gloves, goggles, safety footwear, and protective clothing when removing or handling straps. Failure to do so may result in serious bodily injury or loss of sight.

Cut all concrete products only in well ventilated areas. Inhalation of dust is a serious health risk. A "NIOSH" (US) or a "CSA" (CDN) approved respirator, safety goggles, hearing protectors, and gloves must be worn at all times. Always "wet-cut" or "wet grind" concrete products to minimize dust.

Do not stack bundled concrete products higher than 2 bundles high. Contents of the bundle may be unstable and subject to topple when stacked. Always use extreme caution and appropriate equipment when transporting or storing bundled concrete products. Failure to do so may result in serious bodily injury or death. Always obey gross vehicle weight (GVW) loading limitations and regulations.

Hazard Rating: Fire 0, Health 1, Reactivity 0. See MSDS Concrete Masonry (Pavers). Contact Unilock for complete sheet or view safety information at [Unilock.com](http://Unilock.com).

Unilock assumes no liability or responsibility for loss or damage, resulting from the improper use or handling of our products, or from failure to follow instructions, warnings, and/or advisories on the product label, and on the MSDS sheet.

## TRADEMARK & LEGAL INFORMATION

Umbriano® is a trademark of Metten Stein + Design GmbH & Co KG used under license by Unilock. Unilock Ltd. and Hengestone Holdings, Inc. are the owners or authorized users of all trademarks used in this publication unless otherwise specified.

Colors shown in this brochure should be used only as a guide. Colors should always be chosen from actual samples. Contact your local Unilock representative for color availability in your area. Not all products shown are available at all Unilock locations. Log on to [www.unilock.com](http://www.unilock.com) for availability. Measurements throughout this portfolio are nominal.

©2025 Hengestone Holdings, Inc.

---

# Terms and Conditions of Sale

---

1. All orders are accepted subject to prevailing state or other taxes, and subject to the cost of freight applying at the time of shipment.
2. The acceptance by the Seller of an order shall constitute a binding contract of purchase and sale in accordance with the terms set out in this agreement.
3. These terms and conditions together with the purchase order form and the complete contract, have no representatives, warranties, or conditions expressed or implied affecting this contract other than as contained herein.
4. All sales are made in accordance with the Seller's samples, which the Purchaser has seen and approved. No guarantee of exact color shades is made.
5. "F.O.B. Job-Site" means "delivered to curb line."
6. Use of any delivered materials by, or on behalf of the Purchaser, shall be deemed to constitute acceptance of the materials by the Purchaser.
7. Defective material in excess of the industry standard of 2% delivered to the Purchaser will be replaced free of charge if a claim is made within five days. Free replacement will be the extent of the Seller's warranty. Any such claim will not constitute a reason for delaying payment.
8. Unsuitable or unsatisfactory materials must be available for inspection by the Seller to entitle the Purchaser to any adjustment or credit.
9. No materials may be returned for credit except with the written consent of the Seller whether such materials were ordered in excess of the Purchaser's requirement, by mistake or otherwise.
10. Where the Seller agrees to accept the return of goods, these goods are subject to freight charges and a restocking charge of 20% of their value plus delivery. All goods must be returned in their original package and in selling condition.
11. All special orders will require a 50% deposit and must be shipped within 30 days of the receipt of the production date.
12. Seller does not accept responsibility for delays in deliveries due to fire, flood, strikes, or any other condition or contingencies beyond its control.
13. The Purchaser is responsible for installation of the materials on the job site and the Seller as no responsibilities in this regard.
14. All orders, other than "charge on account orders", must be paid by cash, certified check, or credit card before delivery can be scheduled.
15. All accounts are payable within thirty days from the date of invoice. After 30 days, interest will be charged at 1-1/2% per month calculated monthly on the balance owing at the beginning of the period. In default of payment of any part of any money due under this account, the whole amount remaining unpaid shall, at the option of the Seller, immediately become due and payable.
16. Excessive delays incurred on the delivery will be billed to the Purchaser at \$75 per hour. Delivery time in excess of one hour.
17. All loads must be strapped down before leaving our yard.
18. Title and ownership of the goods shall not pass to the purchaser until the entire amount owing, including interest, is paid in full.

## **LIMITED WARRANTY:**

Unilock's internal testing suggests that the SkyView wind uplift system can significantly reduce the likelihood of rooftop paver failure or damage due to strong wind conditions; EXCEPT AS EXPRESSLY PROVIDED HEREIN, UNILOCK MAKES NO REPRESENTATIONS OR WARRANTIES WHATSOEVER WITH RESPECT TO THE PRODUCTS, WHETHER EXPRESS OR IMPLIED. WITHOUT LIMITING THE GENERALITY OF THE FOREGOING, UNILOCK HEREBY DISCLAIMS ALL OTHER WARRANTIES, INCLUDING THE IMPLIED WARRANTIES OF MERCHANTABILITY OR FITNESS FOR ANY PARTICULAR PURPOSE. SPECIFICALLY, UNILOCK DOES NOT REPRESENT OR WARRANT THAT ITS ROOFTOP PEDESTAL SYSTEMS OR ITS ROOFTOP TILES, SLABS OR PAVERS WILL REMAIN IN PLACE IN ALL HIGH WIND CONDITIONS.

## **LIMITATION OF LIABILITY:**

EXCEPT AS OTHERWISE EXPRESSLY SET FORTH HEREIN, IN NO EVENT SHALL UNILOCK BE LIABLE TO BUYER FOR ANY DIRECT, INCIDENTAL, INDIRECT, SPECIAL, PUNITIVE, EXEMPLARY, TORT OR CONSEQUENTIAL DAMAGES, INCLUDING BUT NOT LIMITED TO ANY DAMAGES FOR BUSINESS INTERRUPTION OR THE LOSS OF REVENUES, PROFITS OR SAVINGS, WHETHER OR NOT SUCH DAMAGES WERE FORESEEN, UNFORESEEN OR FORESEEABLE, EVEN IF UNILOCK HAS BEEN ADVISED OF THE POSSIBILITY OF SUCH DAMAGES. NOTWITHSTANDING THE FOREGOING, IN THE EVENT THE TERMS OF THIS SECTION, OR ANY PART THEREOF, SHALL BE HELD BY A COURT OF COMPETENT JURISDICTION TO BE INVALID OR UNENFORCEABLE, UNILOCK'S TOTAL AGGREGATE LIABILITY TO BUYER WITH RESPECT TO THE PRODUCTS SHALL NOT EXCEED THE PURCHASE PRICE OF THE PRODUCTS GIVING RISE TO THE CLAIM. NOTWITHSTANDING THE FOREGOING, THIS SECTION SHALL NOT RELIEVE UNILOCK FROM LIABILITY FOR DAMAGES THAT RESULT FROM UNILOCK'S OWN GROSS NEGLIGENCE OR WILLFUL OR TORTIOUS ACTS.

## **Additional Pricing Information**

1. All prices are F.O.B. Brighton, MI and payable on a net 30 day basis.
2. Phone order desk for shipping schedules, rates and conditions.
3. Product shipped without skids. Refundable skids available upon request and are subject to a \$35.00 deposit for Yorkstone, Rivenstone and Ledgestone and a \$35.00 deposit for all other material. Skids are refundable at the rate of \$34.00 per skid for Yorkstone, Rivenstone and Ledgestone and \$34.00 for all other skids upon return (in re-useable condition) by the purchaser. Return delivery of skids by Unilock must be coordinated in advance and is subject to the minimum shipping charge for the appropriate zones.
4. Configurations may vary from time to time due to mold design changes.
5. Sectioning charge is \$15.00 per bundle.
6. Non-stock products not listed in this price list that are transferred from other Unilock facilities may be subject to a transfer charge. Please contact Customer Service or your Territory Manager for details.

## **CONFIRM PRICES AS THEY ARE SUBJECT TO CHANGE**

# Unilock Finishes

When considering the finish, think about the look you are trying to achieve as well as practical performance. From traditional smooth and flagstone, to enhanced surfaces, modern granite looks and timeworn patina, Unilock offers it all.

**Smooth finish**



Sometimes, simple is best. A smooth surface suits contemporary styles and is available in a wide variety of shapes for paving and verticals.

**Flagstone finish**



Popular for centuries, a flagstone finish never fails to add warmth to outdoor spaces.

**ANTIQUED FINISH**



A variety of methods are used to achieve this distressed finish, but in every case, it lends a relaxed, rustic vibe.

**Timeworn**



Our exclusive Elegance line offers the look of centuries-old cobblestone, brick, and natural stone with unsurpassed product durability.

**BRUSHED FINISH**

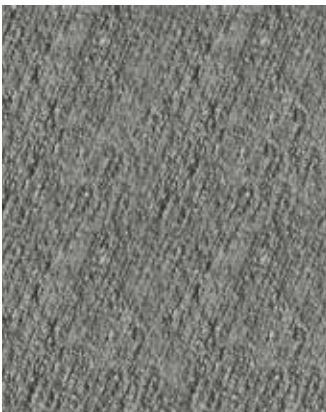

Only Unilock offers Il Campo®, a unique surface enhanced with graphically interesting etched lines. This finish has long been a favorite of commercial designers.

**umbriano**



Umbriano is an exclusive finish only available from Unilock with color and granite particles that are randomly dispersed to achieve a unique mottled surface that is reminiscent of granite.

**EXPOSED GRANITE**

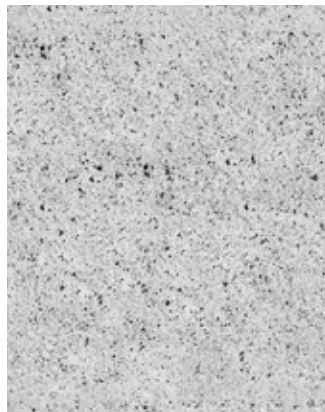

Granite, Quartz and Marble particles are embedded in the product's surface and then revealed using additional processing methods.

**Enhanced surface**



The surface of these products is enhanced using a special process to reveal a variety of distinctive colors and textures.



# THE PERFECT MATCH FOR UNILOCK PAVERS



U-Cara™



SienaEdge™



Estate Wall™

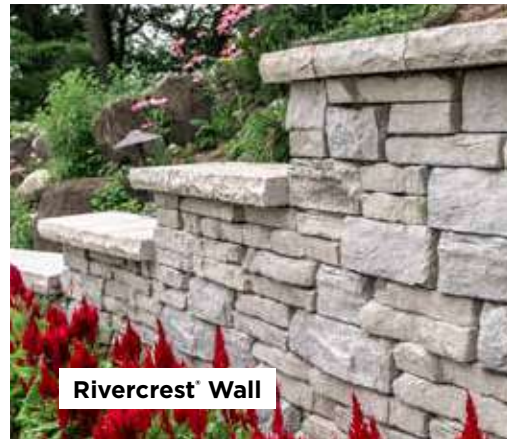

Rivercrest™ Wall



Quarry Smooth™



## **UNILOCK WALLS: STRENGTH MEETS STYLE**

Complete your projects with wall blocks designed to coordinate seamlessly with Unilock pavers. Rich textures and premium colors create cohesive outdoor spaces, with blocks that deliver four times the industry standard for strength.

# Let's **BUILD YOUR BUSINESS TOGETHER.**

**CONTACT 1-800-UNILOCK OR VISIT UNILOCK.COM TO  
CONNECT WITH YOUR LOCAL TERRITORY MANAGER**

**CHICAGO**

(630) 892-9191

**MILWAUKEE**

(262) 742-3890

**KANSAS**

(913) 417-7985

**BOSTON**

(508) 278-4536

**NEW YORK**

(845) 278-6700

**MID-ATLANTIC**

(202) 798-2060

**MICHIGAN**

(248) 437-7037

**CINCINNATI/KY/TN**

(513) 202-0219

**OHIO/WESTERN PA/  
WNY&CNY**

(330) 927-4000

**ONTARIO**

(416) 646-9000

**UNILOCK®**

**UNILOCK.COM | 1-800-UNILOCK**

